

# **HP 8341A SYNTHESIZED SWEEPER (Including Options 001, 002, 004, 005, 006, and 007)**

## **SERIAL NUMBERS**

This manual applies directly to the HP Model 8341A Synthesized Sweeper having a serial number prefix of 2434A.

For additional information about serial numbers, refer to INSTRUMENTS COVERED BY MANUAL in Section I.

© Copyright      HEWLETT-PACKARD COMPANY      1984  
1400 FOUNTAINGROVE PARKWAY, SANTA ROSA, CA 95401, U.S.A.

MANUAL PART NO. 08341-90001  
Microfiche Part No. 08341-90002

Printed: OCTOBER 1984



**HEWLETT  
PACKARD**

## CERTIFICATION

*Hewlett-Packard Company certifies that this product met its published specifications at the time of shipment from the factory. Hewlett-Packard further certifies that its calibration measurements are traceable to the United States National Bureau of Standards, to the extent allowed by the Bureau's calibration facility, and to the calibration facilities of other International Standards Organization members.*

## WARRANTY

This Hewlett-Packard instrument product is warranted against defects in material and workmanship for a period of one year from date of shipment, or, in the case of certain major components listed in section six of this Operating and Service manual, for the specified period. During the warranty period, Hewlett-Packard Company will, at its option, either repair or replace products which prove to be defective.

For warranty service or repair, this product must be returned to a service facility designated by HP. Buyer shall prepay shipping charges to HP and HP shall pay shipping charges to return the product to Buyer. However, Buyer shall pay all shipping charges, duties, and taxes for products returned to HP from another country.

## LIMITATION OF WARRANTY

The foregoing warranty shall not apply to defects resulting from improper or inadequate maintenance by Buyer, Buyer-supplied software or interfacing, unauthorized modification or misuse, operation outside of the environmental specifications for the product, or improper site preparation or maintenance.

NO OTHER WARRANTY IS EXPRESSED OR IMPLIED. HP SPECIFICALLY DISCLAIMS THE IMPLIED WARRANTIES OF MERCHANTABILITY AND FITNESS FOR A PARTICULAR PURPOSE.

## EXCLUSIVE REMEDIES

THE REMEDIES PROVIDED HEREIN ARE BUYER'S SOLE AND EXCLUSIVE REMEDIES. HP SHALL NOT BE LIABLE FOR ANY DIRECT, INDIRECT, SPECIAL, INCIDENTAL, OR CONSEQUENTIAL DAMAGES, WHETHER BASED ON CONTRACT, TORT, OR ANY OTHER LEGAL THEORY.

## ASSISTANCE

*Product maintenance agreements and other customer assistance agreements are available for Hewlett-Packard products.*

*For any assistance, contact your nearest Hewlett-Packard Sales and Service Office. Addresses are provided at the back of this manual.*

## VOLUME 1 CONTENTS

Section	Page	Section	Page
I	GENERAL INFORMATION . . . . .	2-10.	Power Cable . . . . .
1-1.	Introduction . . . . .	2-13.	HP-IB Address Selection . . . . .
1-7.	Specifications . . . . .	2-15.	Interface Function Codes . . . . .
1-9.	Safety Considerations . . . . .	2-17.	Mating Connectors . . . . .
1-11.	Instruments Covered by Manual . . . . .	2-19.	HP-IB, HP 8410, and HP 8755 Interface Connectors . . . . .
1-16.	Description . . . . .	2-21.	Internal Oscillator Selection and Warmup Time . . . . .
1-25.	Options . . . . .	2-24.	Operating Environment . . . . .
1-26.	Option 001, Front Panel RF Output, With 90 dB Programmable Attenuator . . . . .	2-25.	Temperature . . . . .
1-28.	Option 002, +13 dBm Output Power, 2.3 to 18.6 GHz . . . . .	2-26.	Humidity . . . . .
1-30.	Option 004, Rear Panel RF Output with 90 dB Attenuator . . . . .	2-27.	Altitude . . . . .
1-32.	Option 005, Rear Panel RF OUTPUT with No Attenuator . . . . .	2-28.	Cooling . . . . .
1-34.	Option 006, Pulse Modulation . . . . .	2-29.	Front Handles Kit . . . . .
1-36.	Option 007, Improved phase noise specifications . . . . .	2-31.	Chassis Slide Kit (Option 806) . . . . .
1-38.	Option 806, Chassis Mount Slide Kit . . . . .	2-33.	Rack Flange Kit (Option 908) . . . . .
1-40.	Option 850, Model 8410B/C Interface Cable . . . . .	2-35.	Rack Mounting with Handles (Option 913) . . . . .
1-42.	Option 908, Rack Flanges without Handles Kit . . . . .	2-37.	Storage and Shipment . . . . .
1-44.	Option 910, Extra Manual Set . . . . .	2-38.	Environment . . . . .
1-46.	Option 913, Rack Flanges with Handles Kit . . . . .	2-41.	Packaging . . . . .
1-48.	Option 914, Delete Service Documentation . . . . .	2-42.	Original Packaging . . . . .
1-50.	Equipment Required But Not Supplied . . . . .	2-43.	Other Packaging . . . . .
1-53.	Equipment Available . . . . .	2-44.	Blue Service Tags . . . . .
1-54.	Service Accessories . . . . .	2-46.	Incoming Inspection Procedure . . . . .
1-56.	HP 8410C/8411A Network Analyzer . . . . .	III	OPERATING INFORMATION
1-58.	HP Model 8756/55 Scalar Network Analyzers . . . . .	Introduction . . . . .	3-1
1-62.	Power Meters and Crystal Detectors . . . . .	LOCAL OPERATING INFORMATION	
1-64.	Recommended Test Equipment . . . . .	Power dBm Display . . . . .	3-7
II	INSTALLATION . . . . .	START/CW/CF Frequency Display . . . . .	3-9
2-1.	Introduction . . . . .	STOP/ $\Delta$ F Frequency Display . . . . .	3-10
2-3.	Initial Inspection . . . . .	Entry Display . . . . .	3-11
2-5.	Preparation For Use . . . . .	Function . . . . .	3-13
2-6.	Power Requirements . . . . .	KNOB/STEP Entry . . . . .	3-16
2-8.	Line Voltage and Fuse Selection . . . . .	Frequency Marker . . . . .	3-18
		Entry . . . . .	3-20
		Sweep and Trigger . . . . .	3-22
		Instrument State . . . . .	3-24
		Power Switch, Sweep Output . . . . .	3-26
		Modulation . . . . .	3-27
		Modulation Input . . . . .	3-28
		Leveling . . . . .	3-29
		RF Output . . . . .	3-31
		Rear Panel BNC Connectors . . . . .	3-33
		Rear Panel RF Output . . . . .	3-35
		HP-IB Connector . . . . .	3-36
		HP 8410 Interface . . . . .	3-38

## VOLUME 1 CONTENTS (Cont'd)

Section	Page	Section	Page
HP 8755C Interface .....	3-40	Power dBm Display used with AM .....	3-102
Fan Assembly .....	3-41	Dynamic Range .....	3-102
Power Line Module .....	3-42	Bandwidth for AM Applications .....	3-102
<b>HP-IB PROGRAMMING</b>		<b>PULSE MODULATION (Opt. 006) .....</b>	<b>3-103</b>
<b>INFORMATION .....</b>	<b>3-43</b>	Sample and Hold Leveling .....	3-103
Introduction .....	3-43	Response Time .....	3-106
Interconnective Cabling .....	3-43	Unleveled Mode Used with	
Instrument Addresses .....	3-43	Pulse Modulation .....	3-107
HP-IB Instruments Nomenclature .....	3-43	Input Characteristics .....	3-108
Programming the HP 8341A .....	3-43	Pulse Envelope .....	3-108
HP-IB Command Statements .....	3-44	Source Match .....	3-108
HP 8341A Programming Codes .....	3-49	Video Feedthrough .....	2-109
Programs that Duplicate Front		<b>FURTHER INFORMATION .....</b>	<b>3-109</b>
Panel Operations .....	3-49		
Using the Rotary KNOB .....	3-54	<b>IV PERFORMANCE TESTS .....</b>	<b>4-1</b>
Using Keys that Toggle ON/Off .....	3-54	4-1. Introduction .....	4-1
Operator's Programming Check .....	3-54	4-3. Equipment Required .....	4-1
Unique HP-IB Programming Codes .....	3-55	4-5. Test Record .....	4-1
System Timing .....	3-74	4-7. Calibration Cycle .....	4-1
HP-IB Programming Techniques for		4-9. Internal Time Base Aging Rate .....	4-3
Special Applications .....	3-75	4-10. Frequency Range and CW	
HP-IB Pin-Out Description .....	3-75	Mode Accuracy .....	4-6
The Twelve HP-IB Messages .....	3-79	4-11. Sweep Time Accuracy .....	4-12
Computer Access of HP-IB Lines .....	3-85	4-12. Swept Frequency Accuracy .....	4-14
Sending HP-IB Messages .....	3-85	4-13. Maximum Leveled Output Power and	
Reading HP-IB Messages .....	3-86	Power Accuracy Test .....	4-18
Direct Writing to the HP-IB Lines .....	3-88	4-14. External Leveling .....	4-26
<b>USING THE HP 8341A POWER CONTROL</b>		4-15. Spurious Signals Test	
<b>AND MODULATION SYSTEMS .....</b>	<b>3-91</b>	(10 MHz to 20 GHz) .....	4-30
<b>INTERNAL LEVELING .....</b>	<b>3-91</b>	4-16. Intentionally Omitted	
Coupled Mode .....	3-91	4-17. Single Sideband Phase Noise .....	4-36
Power dBm Display .....	3-91	4-18. Power Sweep Test .....	4-43
Decoupled Mode .....	3-93	4-19. Pulse Modulation On/Off	
UNLEVELED MODE .....	3-95	Ratio Test .....	4-46
EXTERNAL LEVELING .....	3-97	4-20. Pulse Modulation Rise and Fall	
Detector Characteristics .....	3-98	Time Test .....	4-48
<b>POWER dBm Display used with the</b>		4-21. Pulse Modulation Accuracy Test .....	4-52
Attenuator (Opt. 001, 004) .....	3-98	4-22. Pulse Modulation Video	
Bandwidth .....	3-100	Feedthrough Test .....	4-56
<b>AMPLITUDE MODULATION .....</b>	<b>3-101</b>	4-23. Amplitude Modulation Test .....	4-60
		4-24. HP 8341A HP-IB Operation	
		Verification Test .....	4-64

**TABLES**

Table	Page	Table	Page
1-1. Model HP 8341A Specifications and Supplemental Performance Characteristics.....	1-6	4-14. dBV vs Voltage Reference Table.....	4-29
1-2. Recommended Test Equipment.....	1-21	4-15. Spurious Signals Test (10 MHz to 20 GHz) Specifications.....	4-30
2-1. Line Voltage/Fuse Selection.....	2-2	4-16. Intentionally Omitted	
2-2. AC Power Cables Available.....	2-3	4-17. Single-sideband Phase Noise Specifications.....	4-36
2-3. HP 8341A Mating Connectors.....	2-5	4-18. Phase Noise Calibration Data.....	4-39
3-1. Index by Mode and Function.....	3-4	4-19. Phase Noise Measurement Data.....	4-40
3-2. HP 8341A Programming Codes.....	3-51	4-20. Phase Noise Test Frequencies.....	4-41
3-3. The Standard ASCII Code.....	3-82	4-21. Phase Noise Test Results.....	4-42
4-1. List of Manual Performance Tests.....	4-2	4-22. Power Sweep Test Specifications.....	4-43
4-2. Internal Time Base Aging Rate Specifications.....	4-3	4-23. Pulse Modulation ON/OFF Ratio Test Specifications.....	4-46
4-3. Frequency Range and CW Mode Accuracy Specifications.....	4-6	4-24. Pulse Modulation Rise and Fall Time Test Specification.....	4-48
4-4. Sweep Time Accuracy Specifications.....	4-12	4-25. Pulse Modulation Accuracy Test Specifications.....	4-52
4-5. Sweep Time Accuracy Limits.....	4-13	4-26. Pulse Modulation Video Feedthrough Test Specification.....	4-56
4-6. Swept Frequency Accuracy Specifications.....	4-14	4-27. Pulse Modulation Video Feedthrough Test Limits.....	4-58
4-7. Swept Frequency Accuracy Test Frequencies.....	4-17	4-28. Amplitude Modulation Test Specifications.....	4-60
4-8. Maximum Leveled Output Power and Power Accuracy Specifications.....	4-18	4-29. HP 8341A Status Byte Description.....	4-66
4-9. Maximum Leveled Output Power Test Work Sheet.....	4-24	4-30. HP 8341A HP-IB Operation Verification Programming Listing (For Use With HP 85F).....	4-67
4-10. External Leveling Specifications.....	4-26	4-31. HP 8341A HP-IB Operation Verification Programming Listing (For Use With HP 9826A or 9836A).....	4-68
4-11. External Leveling Limits (With No Attenuator).....	4-27	4-32. HP 8341A Test Record Card.....	4-69
4-12. External Leveling Limits (With 10 dB Attenuator).....	4-28		
4-13. External Leveling Limits (With 20 dB Attenuator).....	4-28		



## SAFETY CONSIDERATIONS

### GENERAL

This product and related documentation must be reviewed for familiarization with safety markings and instructions before operation. This product has been designed and tested in accordance with international standards.

### SAFETY SYMBOLS



Instruction manual symbol: the product will be marked with this symbol when it is necessary for the user to refer to the instruction manual (refer to Table of Contents).



Indicates hazardous voltages.



Indicates earth (ground) terminal.

#### WARNING

The WARNING sign denotes a hazard. It calls attention to a procedure, practice, or the like, which, if not correctly performed or adhered to, could result in personal injury. Do not proceed beyond a WARNING sign until the indicated conditions are fully understood and met.

#### CAUTION

The CAUTION sign denotes a hazard. It calls attention to an operating procedure, practice, or the like, which, if not correctly performed or adhered to, could result in damage to or destruction of part or all of the product. Do not proceed beyond a CAUTION sign until the indicated conditions are fully understood and met.

### SAFETY EARTH GROUND

This is a Safety Class I product (provided with a protective earthing terminal). An uninterruptible safety earth ground must be provided from the main power source to the product input wiring terminals, power cord, or supplied power cord set. Whenever it is likely that the protection has been impaired, the product must be made inoperative and be secured against any unintended operation.

### BEFORE APPLYING POWER

Verify that the product is configured to match the available main power source per the input power configuration instructions provided in this manual.

If this product is to be energized via an autotransformer, make sure the common terminal is connected to the neutral (grounded) side of mains supply.

### SERVICING

#### WARNING

*Any servicing, adjustment, maintenance, or repair of this product must be performed only by qualified personnel.*

*Adjustments described in this manual may be performed with power supplied to the product while protective covers are removed. Energy available at many points may, if contacted, result in personal injury.*

*Capacitors inside this product may still be charged even when disconnected from its power source.*

*To avoid a fire hazard, only fuses with the required current rating and of the specified type (normal blow, time delay, etc.) are to be used for replacement.*



**HP 8341A SYNTHESIZED SWEEPER**

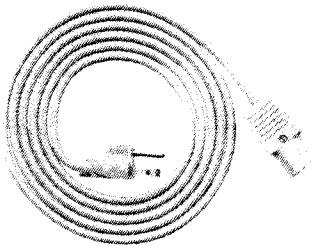

**POWER CABLE\***



HP Part No. 1250-1854  
**50Ω TERMINATION**  
**(For AUX OUTPUT)**



HP Part No. 5061-0090  
**HANDLES KIT**

\* POWER CABLE/PLUG SUPPLIED DEPENDS ON COUNTRY OF SHIPMENT DESTINATION. REFER TO SECTION II, INSTALLATION FOR PART NUMBER INFORMATION.

*Figure 1-1. Model HP 8341A with Accessories Supplied*



## SECTION I GENERAL INFORMATION

### 1-1. INTRODUCTION

1-2. This Operating and Service Manual contains information required to install, operate, test, adjust, and service the Hewlett-Packard Model 8341A Synthesized Sweeper. Figure 1-1 shows the 8341A with accessories supplied.

1-3. The complete 8341A manual set consists of four volumes, divided into eight major sections, which provide the following information:

#### Volume 1

- SECTION I, GENERAL INFORMATION, includes a brief description of the instrument and its documentation layout, safety considerations, specifications and supplemental performance characteristics, instrument identification, options available, accessories available, and a list of recommended test equipment.
- SECTION II, INSTALLATION, provides information for initial inspection, preparation for use, storage, and shipment.
- SECTION III, OPERATION, is subdivided into five sections that describe the instruments features, how to manually and remotely control instrument operation, and how to interface the HP 8341A with other compatible instruments.
- SECTION IV, PERFORMANCE TESTS, presents procedures required to verify that the performance of the instrument is in accordance with published specifications. An HP-IB Operation Verification procedure is also included to test the ability of the HP 8341A to properly communicate on the HP-IB bus. A section is provided for Automated Test Procedures using a computing controller. These are additional or duplicate tests of the Performance Tests and/or Adjustment procedures.

#### Volume 2

- SECTION IV, PERFORMANCE TESTS, is duplicated in this section.
- AUTOMATED TEST PROCEDURE, provides the procedure for performing automated tests. Automated Test Procedure software is required for this test. Refer to Table 1-2 for further information.
- SECTION V, ADJUSTMENTS, presents procedures required to properly adjust and align the HP 8341A after repair.
- SECTION VI, REPLACEABLE PARTS, provides information required to order all parts and assemblies contained in the HP 8341A.
- SECTION VII, MANUAL BACKDATING CHANGES, provides backdating information required to make this manual compatible with earlier shipment configurations.

#### Volumes 3 and 4

- SECTION VIII, SERVICE, includes information to troubleshoot and repair instrument problems.

The Service Section begins with a Service Introduction that describes the section layout and overall instrument theory and troubleshooting concepts. The Service Introduction section then leads the troubleshooter into one of eight Functional Groups, each describing a set of assemblies that serve as a functional unit.

Each Functional Group area includes more detailed information that will lead the troubleshooter to a specific assembly within that group.

Each assembly is then supported with its own separate circuit description, schematic diagram, component location diagram, and troubleshooting information to lead the troubleshooter to the specific circuit or component at fault.

1-4. Supplied with this manual is a second Operating Manual. This copy is intended to be kept with the instrument for use by the instrument operator. Additional copies are available; refer to HP Part Number information on the title page of this volume.

1-5. On the title page of this volume is a "Microfiche" part number. This number may be used to order 10- by 15- centimeter (4- by 6-inch) microfilm transparencies of the complete manual. Each microfiche page contains up to 60 photo duplicates of the manual pages. The microfiche package also includes the latest Manual Changes sheet as well as all pertinent Service Notes.

1-6. Refer any questions regarding this manual, the Manual Changes sheet, or the instrument to the nearest HP Sales/ Service Office. Always identify the instrument by model number, complete name, and complete serial number in all correspondence. Refer to the last tab section in Volume 4 for a worldwide listing of HP Sales/ Service Offices.

## 1-7. SPECIFICATIONS

1-8. Listed in Table 1-1 are the specifications for the HP 8341A; specifications are shaded in the table. These specifications are the performance standards, or limits, against which the instrument may be tested. Also listed in Table 1-1 are the supplemental performance characteristics (not shaded). Supplemental performance characteristics are not specifications but are typical characteristics included as additional information for the user.

## 1-9. SAFETY CONSIDERATIONS

1-10. This product has been manufactured and tested in accordance with international safety standards. Before operation, this product and related documentation must be reviewed for familiarization with safety markings and instructions. A complete listing of Safety Considerations precedes Section I of this manual.

## 1-11. INSTRUMENTS COVERED BY MANUAL

1-12. Attached to the rear panel of the instrument is a serial number plate. A typical serial number plate is shown in Figure 1-2. The serial number is in two parts. The first four digits followed by a letter comprise the serial number prefix. The last five digits form the sequential suffix that is unique to each instrument. The content of this manual applies directly to instruments having the same serial number prefix as those listed on the title page of this manual under SERIAL NUMBER.

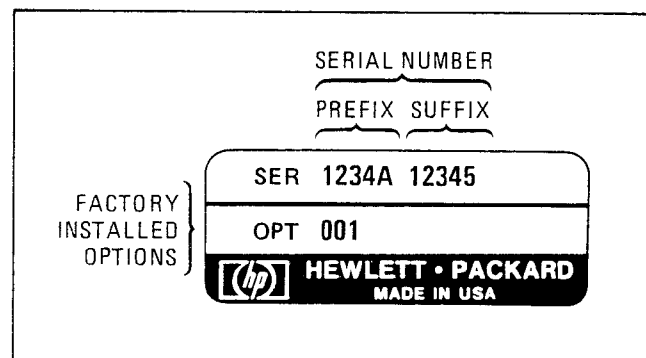

Figure 1-2. Typical Serial Number Plate

1-13. An instrument manufactured after the printing of this manual may have a serial prefix that is not listed on the title page. An unlisted serial prefix indicates that the instrument is different from those documented in this manual. The manual for the instrument is then supplied with a Manual Changes Supplement that documents the differences.

1-14. In addition to change information, the Manual Changes Supplement contains information for correcting errors in the manual. To keep this manual as current as possible, Hewlett-Packard recommends that you periodically request the latest Manual Changes Supplement. The supplement for this manual is keyed to the manual's print date and part number, both of which appear on the title page. Complimentary copies of the Manual Changes Supplement are available on request from Hewlett-Packard.

1-15. For information concerning a serial number prefix that is not listed on the title page or in the Manual Changes Supplement, contact your nearest Hewlett-Packard Sales/Service Office.

## 1-16. DESCRIPTION

1-17. The HP Model 8341A Synthesized Sweeper is a broadband, analog sweep, frequency synthesizer with versatile modulation and output power control.

1-18. The HP 8341A generates synthesized output frequencies from 10 MHz to 20.0 GHz. Frequency resolution from 1 Hz at 10 MHz to 3 at 20.0 GHz is available. Frequency accuracy is a function of the internal time base accuracy or an external frequency standard. Harmonically-related signals are at least 35 dB below the carrier ( $-35$  dBc) and nonharmonically-related spurious outputs are at least  $-55$  dBc.

1-19. The HP 8341A features Optional AM modulation rates from dc to 100 kHz. Optional pulse modulation circuitry allows rise and fall times of  $<25$  nanoseconds, an ON/OFF ratio of  $>80$  dB, and will pass pulses as narrow as 100 nanoseconds.

1-20. Maximum calibrated output power from the Type N female RF OUTPUT connector is shown in Table 1-1. HP 8341A specifications and supplemental performance characteristics. The lowest output power available in all bands is  $-20$  dBm. Displayed power resolution is 0.05 dB. A Power Sweep function provides the ability to sweep power up to 40 dB.

1-21. The HP 8341A is capable of generating a true analog sweep across its entire 10 MHz to 20.0 GHz frequency range. Additionally, a synthesized sweep mode allows precision analog sweeps as narrow as 100 Hz.

1-22. Additional features include five calibrated frequency markers and various sweep modes oriented around stored marker positions. The ability to Save and Recall up to 9 front panel settings also allows an Alternate Sweep function.

1-23. The front panel ENTRY DISPLAY shows the current active function and its appropriate values. Data entry is quickly accomplished through the use of the numeric keyboard, step keys, or RPG (Rotary Pulse Generator) control. All front panel functions, except the line switch, are programmable through the HP-IB bus.

1-24. Many serviceability features have also been incorporated in the HP 8341A. An internal SELF TEST is run each time the instrument is turned on or when the front panel INSTR PRESET KEY is pressed. Front panel diagnostic

routines are accessible to aid in fault detection and isolation. Additional detailed information on troubleshooting and repair procedures is included in Appendix A In Case of Difficulty (in this volume), or in Section VIII, Service, (in Volumes 3 and 4).

## 1-25. OPTIONS

### 1-26. Option 001, Front Panel RF Output, With 90 dB Programmable Attenuator

1-27. The standard instrument configuration has a front panel RF OUTPUT connector with no attenuator. Option 001 instruments have the 90 dB programmable attenuator. The lower limit of the output power range is then  $-110$  dBm.

### 1-28. Option 002, +13 dBm Output Power, 2.3 to 18.6 GHz.

1-29. Option 002 provides +13 dBm output power from 2.3 to 18.6 GHz on instruments with a front panel RF output connector and no programmable attenuator. Refer to Table 1-1 for Option 002 output power from instruments equipped with a rear panel RF output connector and/or a 90 dB programmable attenuator.

### 1-30. Option 004, Rear Panel RF Output with 90 dB Attenuator

1-31. Option 004 instruments have the RF OUTPUT connector mounted on the rear panel instead of the front panel. The 90 dB Programmable Attenuator is installed, thereby allowing the output power level to be set as low as  $-110$  dBm.

### 1-32. Option 005, Rear Panel RF OUTPUT with No Attenuator

1-33. Option 005 instruments have the RF OUTPUT connector mounted on the rear panel and the 90 dB Programmable Attenuator is not installed. The lower limit of the output power level is then  $-20$  dBm.

### 1-34. Option 006, Pulse Modulation

1-35. Option 006 provides external pulse modulation capability.

### 1-36. Option 007, Improved phase noise specifications

1-37. Instruments equipped with Option 007 are warranted to conform to more stringent phase noise specifications. Refer to Table 1-1 for actual specifications.

**1-38. Option 806, Chassis Mount Slide Kit**

1-39. This kit includes the necessary hardware to mount sliding rack mounts on the HP 8341A. This allows easier access to the HP 8341A when mounted in an equipment rack. It is necessary to remove the instrument side panels in order to install the kit. This is described in detail in Section II, Installation, in this volume.

**1-40. Option 850, HP 8410B/C Interface Cable**

1-41. This cable permits multi-octave operation of the HP 8410B/C Network Analyzer with the HP 8341A. This cable is also available separately as HP Part Number 08410-60146. Detailed operation instructions for the use of this cable are included in Section III, Operation, in this volume.

**1-42. Option 908, Rack Flanges without Handles Kit**

1-43. Option 908 contains a pair of flanges and the necessary hardware to mount the HP 8341A in the equipment rack with 482.6mm (19 inches) horizontal spacing. Refer to Section II, Installation, in this volume for a detailed description of the parts in this kit and for installation instructions.

**1-44. Option 910, Extra Manual Set**

1-45. Each instrument is supplied with one complete copy of the four-volume Operating and Service Manual binder set (refer to Option 914). Each Option 910 ordered provides one additional manual binder set. To obtain additional Operating and Service Manual binder sets after receiving the initial instrument shipment, order by manual part number, listed on the title page of this volume. The title page also lists part numbers of manual parts that are individually available.

**1-46. Option 913, Rack Flanges with Handles Kit**

1-47. Option 913 contains a pair of flanges, a pair of handles, and the necessary mounting hardware to mount the instrument in an equipment rack with 482.6mm (19 inches) horizontal spacing. This kit differs from Option 908 kits in that the flanges accommodate the added handles. This makes it easier to hold and position the instrument when installing or removing the instrument from the rack, or, when handling the instrument on a bench. Detailed installation instructions for this kit are included in Section II, Installation.

**1-48. Option 914, Delete Service Documentation**

1-49. Option 914 orders delete Volumes 2, 3, and 4. This allows customers with more than one instrument to reduce the cost and space requirements for duplicate documentation materials.

**1-50. EQUIPMENT REQUIRED BUT NOT SUPPLIED**

1-51. The HP 8341A is ready for use as received; no additional equipment is required for manual operation (from the front panel controls) other than standard cables and adapters required for the specific application.

1-52. To use the HP-IB capabilities of the HP 8341A, a computing controller, such as the HP 85, HP 9826, or HP 9836 is required.

**1-53. EQUIPMENT AVAILABLE****1-54. Service Accessories**

1-55. A Service Accessory Kit is available as HP Part Number 08340-60134. This kit includes a variety of extender boards, cables, and adapters that will aid in servicing the HP 8341A.

**1-56. HP 8410C/8411A Network Analyzer**

1-57. The HP 8341A is compatible with the HP HP 8410B/C Network Analyzer system. The combination of the HP 8410B/C Network Analyzer, the HP 8411A Frequency Converter, and an appropriate display plug-in forms a phasemeter and a ratiometer for direct phase and amplitude ratio measurements on RF voltages. These measurements can be made on single frequencies and on swept frequencies from 110 MHz to 18 GHz. The HP 8410B/C has an Auto-Frequency range mode which gives it the capability of automatically tracking the HP 8341A over octave and multi-octave frequency bands. Two interconnections to the HP 8341A are necessary to ensure that the HP 8410B/C will phase lock properly. The HP 8410B/C Source Control Cable (HP Part Number 08410-60146) connects the HP 8410B/C rear panel SOURCE CONTROL connector to the HP 8341A rear panel 8410B INTERFACE connector. Additionally, the HP 8341A rear panel 1V/GHz output connects to the HP 8410B/C rear panel FREQ REF INPUT. The HP 8410B INTERFACE connector pins and signals are illustrated in Section II, Installation, in this volume. Additional information on interfacing with the HP 8341A with the HP 8410 is included in Section III, Operation, in this volume.

### 1-58. HP Model 8756/55 Scalar Network Analyzers

1-59. The HP 8341A is directly compatible with the HP 8756A or HP 8755C scalar network analyzer for broadband swept scalar measurements. The HP 8756/55 provides a 27.8 KHz square wave AM modulation output. This output can be routed directly into the HP 8341A AM input connector. When [SHIFT] [PULSE] is selected on the HP 8341A, the RF OUTPUT will then be modulated at 27.8 KHz, thereby providing the correct modulation frequency for the HP 8756/55 ac detection scheme. Pressing [SHIFT] [PULSE] is not necessary when an HP 8756A is used with its System Interface connected to the HP 8341A's HP-IB connector. This built-in modulation feature eliminates the need for an external modulator.

1-60. The HP 8341A can also sequence alternate sweeps in the HP 8756/55 through the use of the ALT function. This works in conjunction with the channel switching circuits in the HP 8756/55. This permits Channel 1 on the HP 8756/55 to respond only to the HP 8341A current state and Channel 2 to the alternate state. In the case of an HP 8755C, a single cable (HP Part Number 8120-3174) connects between the HP 8341A rear panel 8755 INTERFACE connector and the HP 8755C front panel ALT SWP INTERFACE connector to provide the necessary signals for channel sequencing. The HP 8341A rear panel 8755 INTERFACE connector pins and signals are illustrated in Section II, Installation, in this volume. Additional information on interfacing the HP 8341A with the HP 8755C is included in Section III, Operation, in this volume. The HP 8755C is included in Section III, Operation, in this volume. The HP 8756A needs no special interface cable. All alternate sweep handshaking is done by means of the System Interface cable.

1-61. The HP 8756A Scalar Network Analyzer is a microprocessor-based analyzer capable of making scalar (magnitude only) reflection and transmission measurements at RF and microwave frequencies. The HP 8756A is completely programmable through HP-IB and can control the HP 8341A, the HP 8340A, HP 8350B Sweep Oscillator, or a plotter directly. In addition to the source, a complete HP 8756A measurement

system requires the use of detectors and/or bridges to the R, A, or B inputs on the front panel.

### 1-62. Power Meters and Crystal Detectors

1-63. The RF output can be externally leveled using the HP Model 432, HP Model 435, or HP Model 436 Power Meters, or with positive or negative polarity output crystal detectors. Additional information on interfacing the HP 8341A with power meters and crystal detectors is included in Section III, Operation, in this volume.

### 1-64. RECOMMENDED TEST EQUIPMENT

1-65. Table 1-2 is a complete list of all required equipment for the tests and adjustments supplied in Section IV, Performance Tests, the Automated Test Procedures, and Section V, Adjustments. Test equipment that is used for automated tests is footnoted in the table for easy reference; some equipment is required only for the automated procedures. Test equipment other than that noted in the table may be substituted if it meets or exceeds the critical specifications indicated in the table.

1-66. Most of the procedures required to verify HP 8341A operation are provided in the manual test procedures in Section IV, Performance Tests. Performing the manual tests provide a high level of confidence that the instrument is performing within published specifications. However, these manual tests are not exhaustive. Exhaustive manual tests (e.g. frequency accuracy, harmonics, spurious signals, and verification of the optional 90 dB step attenuator) would be impractical due to the number of required measurement points. Automated tests are available that provide exhaustive performance verification. Frequency switching time can only be performed using an automated test.

1-67. The automated HP 8341A test programs are for use with an HP 9836A Desktop Computer. The test programs are available on five discs. The operating instructions supplied with the discs are also included in the Automated Test Procedures section of this manual. The part number of the Automated Test Procedure is shown in Table 1-2, Recommended Test Equipment.

Table 1-1. Model HP 8341A Specifications and Supplemental Performance Characteristics (1 of 15)

<b>NOTE</b>
<p><b>HP 8341A Specifications</b> are the performance standards, or limits, against which the instrument may be tested; specifications are shaded in this table. The following Specifications apply for temperatures between 0 and +55°C except where noted. Specifications apply with the PEAK function ON in the CW and MANUAL modes of operation, and with periodic use of AUTO TRACKING CALIBRATION in swept operation.</p> <p>Supplemental Performance Characteristics are not shaded in this table and are intended to provide information useful in applying the instrument by giving typical, but non-warranted, performance parameters. These are denoted as "typical", "nominal", or "approximate".</p>
<b>FREQUENCY</b>
<p><b>CW MODE</b></p> <p><b>Range:</b> 0.01 to 20.0 GHz</p> <p><b>Resolution:</b> <math>n \times 1</math> Hz Where <math>n</math> = harmonic multiplication number (1 to 3). Refer to Frequency ranges and Bandswitch Points description below.</p> <p><b>Accuracy:</b> Same as Time Base Accuracy</p> <p><b>Time Base</b></p> <p><b>Frequency:</b> 10 MHz</p> <p><b>Aging Rate:</b> <math>1 \times 10^{-9}</math> per day, <math>2.5 \times 10^{-7}</math> per year after 72 hour warm up if HP 8341A has been disconnected from ac power for less than 24 hours. Aging rate is achieved after 7 to 30 days warm up if HP 8341A has been disconnected from ac power for greater than 24 hours.</p> <p><b>Temperature Coefficient:</b> Typically <math>&lt; 1 \times 10^{-10}</math> per °C</p> <p><b>Change due to 10% line voltage change:</b> Typically <math>&lt; 1 \times 10^{-11}</math></p> <p><b>Accuracy:</b> Overall accuracy of internal time base is a function of time base calibration <math>\pm</math> aging rate <math>\pm</math> temperature effects <math>\pm</math> line effects.</p> <p><b>Switching Time:</b> <math>&lt; 50</math> msec (PEAK function off) (Fast Phase Lock Mode reduces typical switching time to <math>&lt; 20</math> msec.)</p>
<p><b>CENTER FREQUENCY/SWEEP WIDTH MODE (CF/<math>\Delta</math>F)</b></p> <p><b>Range:</b> 10.00005 MHz to 19.999999995 GHz (<b>center frequency</b>) 100 Hz to 19.99 GHz (<b>sweep width</b>)</p> <p><b>Resolution:</b> Approximately 0.1% of sweep width (<math>\Delta</math>F)</p> <p><b>Readout Accuracy</b> with respect to sweep out voltage (sweep time <math>&gt; 100</math> msec):  <math>\Delta \leq n \times 5</math> MHz: <math>\pm 1\%</math> of indicated sweep width (<math>\Delta</math>F) <math>\pm</math> time base accuracy*  <math>\Delta &gt; n \times 5</math> MHz to <math>&lt; n \times 100</math> MHz: <math>\pm 2\%</math> of indicated sweep width (<math>\Delta</math>F)  <math>\Delta \geq n \times 100</math> MHz: <math>\pm 1\%</math> of indicated sweep width (<math>\Delta</math>F), or <math>\pm 50</math> MHz, whichever is less.</p> <p>Where <math>n</math> = harmonic multiplication number (1 to 3). Refer to Frequency Ranges and Bandswitch Points description below.</p> <p>*Time Base affects Center Frequency accuracy only, not sweep width accuracy.</p>

Specifications are shaded: Supplemental Performance Characteristics are not.

Table 1-1. Model HP 8341A Specifications and Supplemental Performance Characteristics (2 of 15)

<b>FREQUENCY (Cont'd)</b>
<p><b>START/STOP MODE</b></p> <p><b>Range</b>            Start: 10 MHz to 19.9999999            Stop: 10.0001 MHz to 20.0 GHz</p> <p><b>Resolution:</b> Typically, the same as Center Frequency/Sweep Width mode.</p> <p><b>Readout Accuracy</b> with respect to sweep out voltage (sweep time &gt; 100 msec):            Same as Center Frequency/Sweep Width Mode.</p>
<p><b>FREQUENCY MARKERS</b></p> <p>All 5 markers are independently variable and have the same specifications.</p> <p><b>Range:</b> 10 MHz to 20.0 GHz</p> <p><b>Resolution:</b> Approximately 0.1% of sweep width (<math>\Delta F</math>)</p> <p><b>Readout Accuracy</b> (sweep time &gt; 100 msec):  <math>\Delta \leq n \times 5 \text{ MHz}</math>: <math>\pm 1\%</math> of indicated sweep width (<math>\Delta F</math>) <math>\pm</math> time base accuracy*.  <math>\Delta &gt; n \times 5 \text{ MHz}</math> to <math>&lt; n \times 100 \text{ MHz}</math>: <math>\pm 2\%</math> of indicated sweep width (<math>\Delta</math>).  <math>\Delta \geq n \times 100 \text{ MHz}</math>: <math>\pm 1\%</math> of indicated sweep width (<math>\Delta F</math>) or <math>\pm 50 \text{ MHz}</math>, whichever is less.</p> <p>Where <math>n</math> = harmonic multiplication number (1 to 3). Refer to Frequency Ranges and Bandswitch Points Description below.</p> <p>*Time base accuracy is not a factor in MKR<math>\Delta</math> Mode.</p>
<p><b>TYPICAL FREQUENCY RANGES AND BANDSWITCH POINTS</b></p> <p>For bands 0 and 1, the HP 8341A's output is derived from the fundamental frequency of its internal 2.3 to 7.0 GHz YIG-tuned oscillator (<math>n = 1</math>). For bands 2 and 3, the output is derived from the 2nd or 3rd harmonic of the oscillator (<math>n = 2</math> or 3).</p> <p>Bandswitch points in CW Mode (only) always occur at the following points:</p> <ul style="list-style-type: none"> <li>Band 0 to 1: 2.3 GHz</li> <li>Band 1 to 2: 7.0 GHz</li> <li>Band 2 to 3: 13.5 GHz</li> </ul> <p>Bandswitch points in each of the swept modes (CF/<math>\Delta F</math>, START/STOP) and the MANUAL SWEEP mode normally occur at the following points (with the exception listed below):</p> <ul style="list-style-type: none"> <li>Band 0 to 1: 2.4 GHz</li> <li>Band 1 to 2: 7.0 GHz</li> <li>Band 2 to 3: 13.5 GHz</li> </ul> <p>The swept mode bandswitch points are illustrated in Figure 1.</p>

Specifications are shaded; Supplemental Performance Characteristics are not.

Table 1-1. Model HP 8341A Specifications and supplemental Performance Characteristics (3 of 15)

**FREQUENCY (Cont'd)**

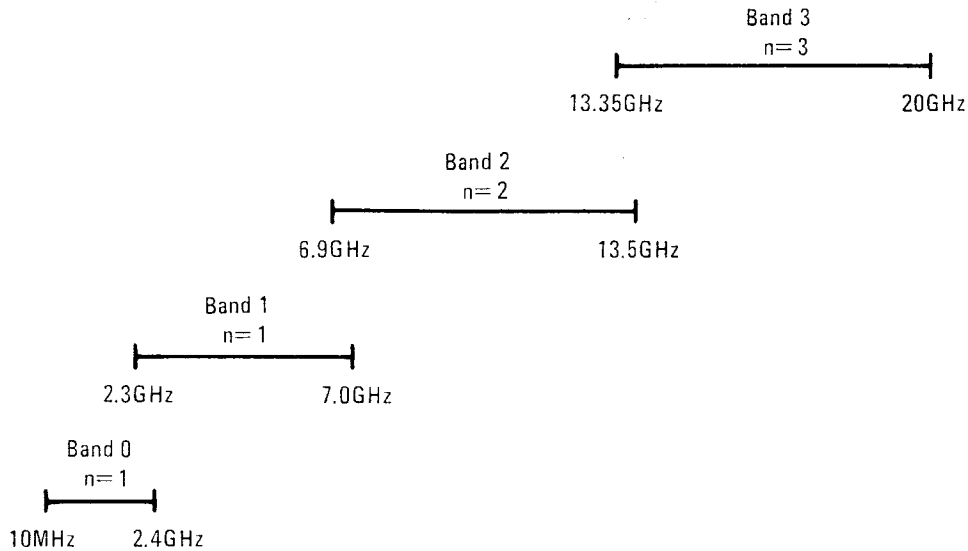

Figure 1. Typical Frequency Ranges and Bandswitch Points in Swept Modes

Note that the bands overlap. However, any sweep will be executed with the minimum number of bandswitch points. If the start frequency is above the lower limit for a given band, the sweep will start in that band and not the next lower one. If the stop frequency exceeds the upper limit of a given band by an amount greater than  $0.004 \times \Delta F$ , a bandswitch will occur at that band's upper limit.

**SPECTRAL PURITY**

(Spectral Purity specifications apply for CW mode and all swept modes, unless otherwise stated.)

SPURIOUS SIGNALS (Expressed in dB relative to the carrier level (dBc) at ALC level of 0 dBm)	Bands and Approximate Frequency Ranges (GHz) (See Frequency Ranges and Bandswitch Points for complete description.)			
	Band 0 0.01 to <2.3	Band 1 2.3 to <7.0	Band 2 7.0 to <13.5	Band 3 13.5 to 20.0
<b>Harmonics</b> (up to 20.0 GHz)	< -35	< -35	< -35	< -35
<b>Subharmonics and multiples thereof</b> (up to 20.0 GHz)	-	-	< -25	< -25
<b>Non-harmonically related spurious</b> (CW and Manual Sweep mode only)	< -50	< -70	< -60	< -60

Specifications are shaded: Supplemental Performance Characteristics are not.



Table 1-1. Model HP 8341A Specifications and Supplemental Performance Characteristics (4 of 15)

<b>SPECTRAL PURITY (Cont'd)</b>				
<b>SPURIOUS SIGNALS (Cont'd)</b>				
Power line related and spurious due to fan rotation within 5 Hz below line frequency, and multiples thereof				
(CW mode only, all power levels)	<b>Band 0</b> 0.001 to <2.3	<b>Band 1</b> 2.3 to <7.0	<b>Band 2</b> 7.0 to <13.5	<b>Band 3</b> 13.5 to 20.0
Offset <300 Hz from carrier	< -50	< -50	< -44	< -40
Offset 300 Hz to 1 kHz from carrier	< -60	< -60	< -54	< -50
Offset > 1 kHz from carrier	< -65	< -65	< -59	< -55
<b>SINGLE-SIDEBAND PHASE NOISE</b> (dBc/1 Hz BW, CW Mode, all power levels)				
Offset 100 Hz from carrier	< -67	< -67	< -61	< -57
Offset 1 kHz from carrier	< -75	< -75	< -69	< -65
Offset 10 kHz from carrier	< -83	< -83	< -77	< -73
Offset 100 kHz from carrier	< -107	< -107	< -101	< -97
<b>OPTION 007. (Improved Phase Noise Specifications)</b>				
Offset 30 Hz from carrier	< -64	< -64	< -58	< -54
Offset 100 Hz from carrier	< -70	< -70	< -64	< -60
Offset 1 kHz from carrier	< -78	< -78	< -72	< -68
Offset 10 kHz from carrier	< -86	< -86	< -80	< -76
Offset 100 kHz from carrier	< -107	< -107	< -101	< -97
<b>TYPICAL FREQUENCY STABILITY, 50 Hz – 15 kHz post detection bandwidth</b>				
Typical Residual FM in CW Mode: <n x 60 Hz rms				
Typical Residual FM in Swept Mode:				
$\Delta F > n \times 5 \text{ MHz}$ : < n x 25 kHz rms				
$\Delta F \leq n \times 5 \text{ MHz}$ : Same as CW mode				
Where n = harmonic multiplication number (1 to 3). Refer to Frequency Ranges and Bandswitch Points description above.				

Specifications are shaded: Supplemental Performance Characteristics are not.



Table 1-1. Model HP 8341A Specifications and Supplemental Performance Characteristics (6 of 15)

<b>RF OUTPUT (Cont'd)</b>		
<b>OUTPUT POWER ACCURACY (Cont'd)</b>	<b>Band 0 0.01 to &lt;2.3</b>	<b>Bands 1 - 3 2.3 to 20</b>
<b>OPTION 001</b> (Front Panel Output w/Attenuator) +18 to +10 dBm <sup>4</sup> +10 to -9.95 dBm -10 to -19.95 dBm -20 to -49.95 dBm -50 to -79.95 dBm -80 to -99.95 dBm -100 to -110 dBm	- ±0.9 dB ±1.2 dB ±1.5 dB ±1.8 dB ±2.1 dB ±2.9 dB <sup>3</sup>	±1.8 dB ±1.5 dB ±2.0 dB ±2.3 dB ±2.6 dB ±2.9 dB ±3.7 dB <sup>3</sup>
<b>OPTION 005</b> (Rear Panel Output w/o Attenuator) +18 to +10 dBm <sup>4</sup> +10 to -10 dBm -10 to -20 dBm	- ±1.0 dB ±1.8 dB	±1.8 dB ±1.5 dB ±2.3 dB
<b>FLATNESS (Internally leveled)</b>		
<b>STANDARD INSTRUMENT</b> +18 to +10 dBm <sup>4</sup> +10 to -10 dBm -10 to -20 dBm	- ±0.6 dB ±0.8 dB	±1.0 dB ±0.9 dB ±1.5 dB
<b>OPTION 004</b> (Rear Panel Output w/Attenuator) +18 to +10 dBm <sup>4</sup> +10 to -11.95 dBm -12 to -21.95 dBm -22 to -51.95 dBm -52 to -81.95 dBm -82 to -99.95 dBm -100 to -110 dBm	- ±0.7 dB ±1.0 dB ±1.3 dB ±1.5 dB ±1.8 dB ±2.0 dB <sup>3</sup>	±1.4 dB ±1.3 dB ±1.8 dB ±2.1 dB ±2.4 dB ±2.7 dB ±3.3 dB <sup>3</sup>
<b>OPTION 001</b> (Front Panel Output w/Attenuator) +18 to +10 dBm <sup>4</sup> +10 to -9.95 dBm -10 to -19.95 dBm -20 to -49.95 dBm -50 to -79.95 dBm -80 to -99.95 dBm -100 to -110 dBm	- ±0.6 dB ±0.9 dB ±1.2 dB ±1.4 dB ±1.7 dB ±1.9 dB <sup>3</sup>	±1.2 dB ±1.1 dB ±1.6 dB ±1.9 dB ±2.2 dB ±2.5 dB ±3.1 dB <sup>3</sup>
<b>OPTION 005</b> (Rear Panel Output w/o Attenuator) +18 to +10 dBm <sup>4</sup> +10 to -10 dBm -10 to -20 dBm	- ±0.7 dB ±0.9 dB	±1.2 dB ±1.1 dB ±1.7 dB

Specifications are shaded; Supplemental Performance Characteristics are not.

Table 1-1. Model HP 8341A Specifications and Supplemental Performance Characteristics (7 of 15)

**RF OUTPUT (Cont'd)**

**TYPICAL ALC INCREMENTAL ACCURACY**

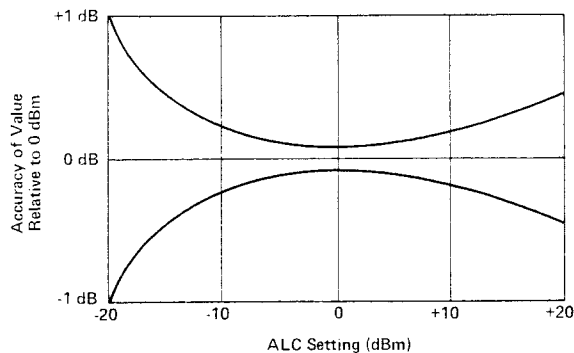

Figure 2. Typical ALC Incremental Accuracy

In instruments equipped with Option 001, the ALC does not operate below  $-9.95$  dBm because the HP 8341A automatically increments the step attenuator at that point. However, when the ALC and step attenuator are independently controlled (DECOUPLED mode), the ALC may be operated over its full  $+20$  dBm to  $-20$  dBm range. Refer to Section III, Operation for a more detailed description. Pressing [SHIFT] [PWR SWP] places the instrument in the Decoupled Mode. In this mode the Data Entry keyboard and the RPG control the ALC level and the step up and step down keys control the attenuator.

**RF OUTPUT CONNECTOR**

**Output Impedance:** Nominally 50 Ohms

**Typical Source SWR** (Internally leveled only):

- 0.1 to <2.3 GHz: Typically <1.3:1
- 2.3 to <18.0 GHz: Typically <1.6:1
- 18.0 to 20.0 GHz: Typically <1.8:1

**STABILITY WITH TEMPERATURE:** Typically  $\pm 0.01$  dB/ $^{\circ}$ C

**OUTPUT LEVEL SWITCHING TIME:**

Typically <10 ms to be within 0.1 dB of final value with no attenuator range change (internally leveled only).

**POWER SWEEP**

**Range:**

- Displayed: 0 to 40 dB/sweep
- Actual: At least 10 dB at any given frequency (at least 20 dB in DECOUPLED mode: see Figure 3 below).

**Resolution:** 0.05 dB/sweep

**Accuracy:**

- Starting Power Level: Same as Output Power Accuracy
- Power Sweep Width and Linearity: See Figure 2.

Specifications are shaded: Supplemental Performance Characteristics are not.

Table 1-1. Model HP 8341A Specifications and Supplemental Performance Characteristics (8 of 15)

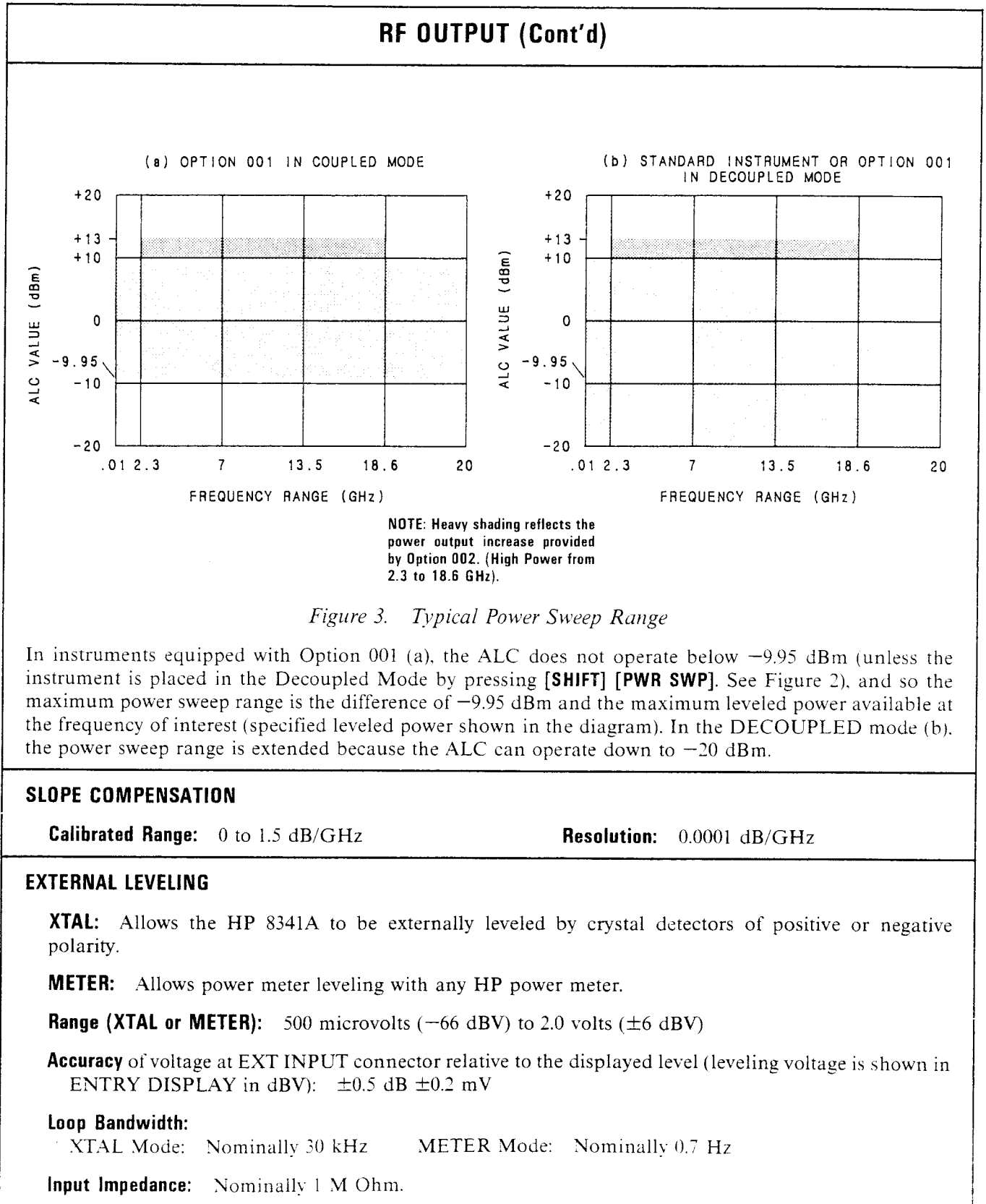

Specifications are shaded: Supplemental Performance Characteristics are not.

Table 1-1. Model HP 8341A Specifications and Supplemental Performance Characteristics (9 of 15)

<b>PULSE MODULATION</b>			
(Pertains only to instruments equipped with Option 006) (CW mode, and all specifications are typical for frequencies <400 MHz)			
<b>ON/OFF RATIO:</b> >80 dB			
<b>RISE (T<sub>R</sub>) AND FALL (T<sub>F</sub>) TIMES:</b> ≤25 nanoseconds			
<b>MINIMUM INTERNALLY LEVELED RF PULSE WIDTH (T<sub>RF</sub>):</b> 100 nanoseconds			
<b>MINIMUM UNLEVELED RF PULSE WIDTH:</b> Typically 25 nanoseconds			
<b>PULSE REPETITION FREQUENCY (PRF)</b> Non-leveled operation (SHIFT METER): Typically dc to 20 MHz. Internally leveled operation: 100 Hz to 5 MHz (typically 100 Hz to 500 kHz for RF frequencies <400 MHz). If [SHIFT] [AM] is pressed (see Settling Time), minimum PRF must be ≥ 1 kHz rather than 100 Hz.			
<b>MAXIMUM PEAK POWER:</b> Same as specified maximum leveled power. (See RF OUTPUT).			
<b>ACCURACY OF INTERNALLY LEVELED RF PULSE V<sub>p</sub> (relative to CW mode level):</b> (Note that the ALC attempts to hold pulse amplitude to same level as leveled CW signal.)			
Bands and Approximate Frequency Ranges (GHz) (see Frequency Ranges and Bandswitch Points for complete description)			
Pulse Width	Band 0		Bands 1 - 3
	0.01 to 0.4	0.4 to <2.3	2.3 to 0.0
100 to <200 ns	—	+3/−0.3 dB*	+1.5/−0.3 dB*
200 to <500 ns	—	+1.5/−0.3 dB*	±0.3 dB
≥500 ns	—	±0.3 dB	±0.3 dB
1 to <2 μs	+3/−0.3 dB <sup>3</sup>	—	—
2 to <5 μs	+1.5/−0.3 dB <sup>3</sup>	—	—
≥5 μs	±0.3 dB <sup>3</sup>	—	—
*+15 to +55°C. Duty Cycle must be > 0.01%.			

Specifications are shaded; Supplemental Performance Characteristics are not.

Table 1-1. Model HP 8341A Specifications and Supplemental Performance Characteristics (10 of 15)

<b>PULSE MODULATION (Cont'd)</b> (Pertains only to instruments equipped with Option 006)		
<b>SIMULTANEOUS AM AND PULSE (Parameters shown are typical)</b>		
<b>AM BANDWIDTH AT 30% DEPTH</b> DC coupled, typical 3 dB point:		
Mode	Internally Leveled	Unleveled (Shift Meter***)
<b>Normal</b> <b>SHIFT AM*</b>	PRF/20**, to a maximum of 5 kHz PRF/10**, to a maximum of 100 kHz	5 kHz 100 kHz
<b>SETTLING TIME TO A STEP INPUT, 10%-90%, TYP:</b>		
<b>Normal</b>	The greater of: 70 $\mu$ sec, or the time for the number of pulses indicated by the solid line below.	70 $\mu$ sec
<b>SHIFT AM*</b>	The greater of: 3.5 $\mu$ sec, or the time for the number of pulses indicated by the dashed line below.	3.5 $\mu$ sec
<p>* [SHIFT] [AM] increases AM bandwidth in pulse mode, but also causes slight degradation of the pulse envelope and raises the minimum PRF to 1 kHz.</p> <p>** PRF = PULSE REPETITION FREQUENCY.</p> <p>*** [SHIFT] [METER] is an unleveled operating mode, power is controllable, but not flat over frequency. AM bandwidth in this mode is independent of pulse rate and width. See Section I.</p>		
<b>OVERSHOOT, RINGING (<math>V_{OR}/V_P</math>):</b> <15% typically		
<b>PULSE WIDTH COMPRESSION (<math>T_V - T_{RF}</math>):</b> $\pm$ 5 nanoseconds typically		
<b>DELAY TIME (<math>T_0</math>):</b> 50 nanoseconds typically		
<b>VIDEO FEEDTHROUGH (<math>V_F/V_P</math>):</b> 0.01 to <0.4 GHz (Band 0): <100% typically 0.4 to <2.3 GHz (Band 0): $\leq$ 5% (for output power levels $\leq$ +8 dBm) 2.3 to 20.0 GHz (Bands 1 - 3): $\leq$ 0.2%		
<b>SIDEBANDS (caused by a pulse input when PULSE is OFF):</b> Typically -50 dBc with a 30 kHz squarewave input from 0.01 to 7.0 GHz.		

Specifications are shaded: Supplemental Performance Characteristics are not.

Table 1-1. Model HP 8341A Specifications and Supplemental Characteristics (11 of 15)

<b>PULSE MODULATION (Cont'd)</b>	
(Pertains only to instruments equipped with Option 006)	
<b>PULSE INPUT CONNECTOR:</b>	
TTL compatible. (Open circuit is TTL high level and keeps RF on.) Damage level is +12 Vdc, -20 Vdc. Refer to Section III, Operation, for input circuit diagram.	
<b>PULSE DEFINITIONS:</b>	
Figure 4. Pulse Definitions	
<b>AMPLITUDE MODULATION</b>	
(The following specifications apply when the HP 8341A is internally leveled, for waveforms whose envelope peak is at least 1 dB below maximum specified power. Unless noted, pulse modulation must be OFF; however, the HP 8341A is capable of simultaneous amplitude and pulse modulation. See Section III, Operation.)	
<b>AM DEPTH:</b> 0 to 90%	
<b>AM SENSITIVITY (at 1 kHz rate and 30% Depth):</b>	
DC coupled, 3 dB point $\geq$ 100 kHz	
PULSE on: DC coupled, 3 dB point $\geq$ PRF/20, typically. (Refer to Pulse Modulation specs for a more complete description.)	
<b>AM FREQUENCY RESPONSE (FLATNESS) (relative to a 1 kHz rate at 30% depth, DC to 10 kHz):</b> $\pm 0.20$ dB	
<b>DISTORTION:</b> Typical distortion values are given in Figure 5.	

Specifications are shaded: Supplemental Performance Characteristics are not.



Table 1-1. Model HP 8341A Specifications and Supplemental Performance Characteristics (12 of 15)

<b>AMPLITUDE MODULATION (Cont'd)</b>	
<p>Figure 5. Typical HP 8341A AM Distortion for Various Modulation Rates and Depths</p>	
<p><b>INCIDENTAL PHASE MODULATION (in peak radians) (Rates <math>\leq 10</math> kHz, 30% Depth):</b> &lt;0.4 typically</p>	
<p><b>INCIDENTAL FM:</b> Incidental Phase Modulation x Modulation Frequency</p>	
<p><b>AM INPUT IMPEDANCE:</b> Nominally 600 Ohms.</p>	
<b>SWEEP TIME</b>	
<p><b>RANGE:</b>                      10 milliseconds to 200 seconds forward sweep times                      Fastest possible sweep typically cycles once every 40 ms; fastest possible full band sweep typically cycles once every 150 ms.</p>	
<p><b>RESOLUTION:</b> Approximately 0.1% of current sweep time value.</p>	
<p><b>ACCURACY:</b> <math>\pm 5\%</math> (sweeptimes <math>\leq 50</math> seconds)</p>	
<b>INPUTS</b>	
<p><b>PULSE MODULATION INPUT</b> (Pertains only to instruments equipped with Option 006)                      Front panel BNC female input connector. TTL compatible (open circuit is TTL high level and keeps RF on). Damage level is +12 Vdc, -20 Vdc.</p>	
<p><b>AM MODULATION INPUT</b>                      Front panel BNC female input connector. Nominal input impedance is 600 Ohms.</p>	
<p><b>LEVELING EXT INPUT</b>                      Front panel BNC female input connector. Used for power meter leveling or crystal detector leveling. Input impedance in XTAL or METER modes is nominally 1 MOhm. Refer to EXTERNAL LEVELING specifications.</p>	
<p><b>FREQUENCY STANDARD EXT</b>                      Rear panel BNC female connector. Accepts 5 or 10 MHz signal from internal or external timebase. A BNC jumper connects this input to the HP 8341A's FREQUENCY STANDARD INT output for operation from HP 8341A's internal timebase. External signal input must be 5 MHz <math>\pm 50</math> Hz or 10 MHz <math>\pm 100</math> Hz, 0 to + dBm. Nominal input impedance is 50 ohms.</p>	

Specifications are shaded: Supplemental Performance Characteristics are not.

Table 1-1. HP Model 8341A Specifications and Supplemental Performance Characteristics (13 of 15)

### INPUTS (Cont'd)

#### EXT TRIGGER INPUT

Rear panel BNC female connector. Triggers single sweep. Trigger signal must be  $> 2$  Vdc (10 Vdc max) and wider than 0.5 microseconds. Nominal input impedance is 2 kOhms.

#### STOP SWP IN/OUT:

Rear panel BNC female connector. TTL high while sweeping, stops sweep when grounded externally. TTL low when HP 8341A stops sweep.

#### HP 8755C INTERFACE

Rear panel. Connects via cable (HP Part No. 8120-3174) to HP 8755C Scalar Network Analyzer to provide Alternate Sweep function.

#### HP 8410B INTERFACE

Rear panel 25-pin D-type connector. Permits multi-octave operation of HP 8410B/C Network Analyzer with HP 8341A, via interface cable (HP Part No. 08410-60146). Also provides duplicates of these functions: **Ext Trigger Input**, **Mute Output**, **Penlift Output**, **Neg Blank**, and **Z-Axis Blank/Mkrs**. Also provides an input for a switch closure to execute the UP key function.

### OUTPUTS

#### RF OUTPUT

Front panel Type N Female connector. Frequency output range is 10 MHz to 20.0 GHz. Nominal output impedance is 50 Ohms. SWR is shown in RF OUTPUT characteristics.

#### SWEEP OUTPUT

Front and rear panel BNC female connectors, supplies a voltage proportional to the sweep that ranges from approximately 0 Vdc (at start of sweep) to approximately +10 Vdc (at end of sweep), regardless of sweep width. In CW mode, the dc voltage is proportional to percentage of full 10 MHz to 20.0 GHz range.

#### 1 V/GHz (19V Max)

Rear panel BNC female connector. Outputs a voltage proportional to output frequency at 1V/GHz, up to a maximum of 19 Vdc. Nominal load impedance should be  $\geq 4$  KOhms. Accuracy of 1V/GHz is  $\pm 1\%$   $\pm 2$ mV.

#### 10 MHz REF OUTPUT

Rear panel BNC female connector. Output power level is nominally 0 dBm. Output impedance is nominally 50 Ohms.

#### FREQUENCY STANDARD INT

Rear panel BNC connector. Output frequency 10 MHz, output power nominally 3 dBm, 50 Ohm nominal output impedance. Jumpered to **FREQUENCY STANDARD EXT** for operation from HP 8341A's internal timebase.

#### MUTE OUTPUT

Rear panel BNC female connector. Mutes servo motor of X-Y recorder when the HP 8341A crosses a band switchpoint.

#### PENLIFT OUTPUT J13

For operation with X-Y recorders, PENLIFT disables an X-Y recorder's ability to lower its pen during sweep retrace. If **[SHIFT] [LINE]** is pressed on the front panel, PENLIFT will also disable the pen during forward sweep band switchpoints. Because of X-Y recorder limitations PENLIFT will always disable the X-Y recorder's pen at sweep times under 5 seconds.

PENLIFT enables pen operation by providing a current path to ground for the X-Y recorder's pen solenoid. The voltage at the PENLIFT output in this state will be approximately 0 Vdc. Circuit impedance in this state is approximately .5 Ohms.

PENLIFT disables pen operation by not providing a current path to ground for the X-Y recorder's pen solenoid. The voltage on the PENLIFT output will be equal to the X-Y recorder's pen solenoid supply voltage. Circuit impedance in this state is very high.

Specifications are shaded; Supplemental Performance Characteristics are not.

Table 1-1. Model HP 8341A Specifications and Supplemental Performance Characteristics (14 of 15)

<b>OUTPUTS (Cont'd)</b>
<p><b>NEG BLANK</b> Rear panel BNC female connector. Supplies negative rectangular pulse (approximately -5 Vdc into 2 kOhm load) during the retrace and band switchpoints of the RF output.</p> <p><b>Z-AXIS BLANK/MKRS</b> Rear panel BNC female connector. Supplies positive rectangular pulse (approximately +5 Vdc into 2 kOhms) during the retrace and band switchpoints of the RF output. Also, supplies a -5 Vdc pulse when the RF is coincident with a marker frequency (intensity markers only).</p> <p><b>AUX OUT</b> Rear panel Type-N female connector. Provides a 2.3 to 7.0 GHz fundamental oscillator output, nominally 0 dBm and 50 Ohm output impedance.</p> <p style="text-align: center;"><b>NOTE</b> For further information refer to the Front/Rear Panel functional group in Section VIII.</p>
<b>REMOTE OPERATION</b>
All functions (except line power) may be programmed via the Hewlett-Packard Interface Bus (HP-IB). Detailed Remote operation information is included in Section III, Operation.
<b>GENERAL</b>
<p><b>ENVIRONMENTAL</b></p> <p><b>Temperature:</b> Operation at 0 to +55°C, except as noted in electrical specifications.</p> <p><b>Humidity:</b> Passes 5 day cycling, +40°C, 95% relative humidity.</p> <p><b>EMI:</b> Controlled and radiated interference is within the requirements of CE03 and RE02 (relaxed by 10 dB) of MIL STD 461A, and within the requirements of VDE 0871/1978, Level B and CISPR publication 11 (1975).</p>
<p><b>WARM-UP TIME</b></p> <p><b>Operation:</b> Requires 30-minute warmup from cold start, 0 to +55°C. Internal temperature equilibrium is reached after 2-hour warmup at stable outside temperature.</p> <p><b>Frequency Reference:</b> Reference time base is kept at operating temperature in STANDBY mode with the instrument connected to the ac power. For instruments disconnected from ac power for less than 24 hours, the aging rate is <math>&lt;1 \times 10^{-9}</math>/day after a 72-hour warmup.</p>
<p><b>POWER REQUIREMENTS</b></p> <p><b>Standard Instrument:</b></p> <p>47.5 to 66 Hz; 100, 120, 220, or 240 volts (<math>\pm 10\%</math>); Typically, 500 VA maximum (40 VA in <b>STANDBY</b>).</p>

Specifications are shaded: Supplemental Performance Characteristics are not.

Table 1-1. Model HP 8341A Specifications and Supplemental Performance Characteristics (15 of 15)

<b>GENERAL (Cont'd)</b>	
<b>WEIGHT</b>	
<b>Net Weight:</b> 34 kg (75 lb)	
<b>Shipping Weight:</b> 52 kg (112 lb)	
<b>DIMENSIONS</b>	
<p>The diagram shows three views of the HP 8341A instrument:                 <ul style="list-style-type: none"> <li><b>TOP View:</b> A rectangular view showing the top surface of the instrument.</li> <li><b>REAR View:</b> A side view showing the rear panel with a width dimension of 425.5 mm (16.75 in).</li> <li><b>SIDE View:</b> A side view showing the depth of the instrument with a dimension of 609.6 mm (24.0 in).</li> <li><b>Height:</b> A vertical dimension line indicates a height of 188 mm (7.4 in).</li> </ul> </p>	
<b>NOTES</b>	
<ol style="list-style-type: none"> <li>1. Maximum leveled power from 35°C to 55°C will typically be degraded from these specifications by no more than 2 dB.</li> <li>2. Internally leveled, AM off. The POWER dBm display monitors the actual output power, giving accurate readings when unlevelled, externally leveled, or when amplitude modulating with a signal that has a dc component. In these modes, the accuracy typically degrades by <math>\pm 0.1</math> dB over the tabulated values. The ENTRY DISPLAY shows the desired power level, or the desired external detector output voltage, exclusive of modulation.</li> <li>3. Typical.</li> <li>4. The ALC loop typically operates up to +20 dBm to enhance usability at those frequencies where leveled power greater than the maximum specified is available.</li> </ol>	

Specifications are shaded; Supplemental Performance Characteristics are not.

Table 1-2. Recommended Test Equipment (1 of 5)

Instrument	Critical Specifications	Recommended Model	Use <sup>1</sup>
Signature Multimeter	Clock Frequency: $\geq 20$ MHz	HP 5005A	T
Oscilloscope	Dual Channel Bandwidth: dc to 100 MHz Vertical Sensitivity: $\leq 5$ mV/Div Horizontal Sensitivity: 50 ns/Div 10 Magnifier External Sweep Capability 50 Ohm Vertical Input	HP 1741A	P,AT,A,T
Oscilloscope Probe	10:1 Divider Probe	HP 10004D	AT,T,A
Digital Voltmeter (DVM)	Range: $-50$ to $+50$ Vdc Accuracy: $\pm 0.01\%$ Input Impedance: $\geq 10$ MOhms	HP 3455/56	P,AT,A,T
Power Meter	Power Range: $1\mu$ W to 100 mW Accuracy: $\pm 0.02$ dB	HP 436A	P,AT,A,T
Power Sensors	Frequency Range: 10 to 50 MHz Power Range: $1\mu$ W to 100 mW	HP 8481A	P,AT,A,T
Frequency Counter	Frequency Range: 50 MHz to 20 GHz Power Range: $1\mu$ W to 100 mW	HP 8485A	P,AT,A,T
	Frequency Range: 10 MHz to 20 GHz Input Impedance: 50 Ohms Frequency Accuracy: Time Base Accuracy $\pm 1$ count	HP 5343A	P,AT,A,T
Universal Counter	Time Interval Range: 100 ns to 200 s	HP 5316A	P,AT,T
Spectrum Analyzers	Frequency Range: 0.01 to 20 GHz Must have External Time Base Input Center Frequency Accuracy in 0 Hz Span: Same as Time Base Accuracy Minimum Resolution Bandwidth: $\leq 300$ Hz Residual FM: $< 100$ Hz Log Fidelity: $\leq 1$ dB Must have Video Output	HP 8566A	P,AT,A,T
Frequency Standard	Frequency Range: 20 Hz to 40 MHz Resolution Bandwidth: $\leq$ Hz	HP 3585A	P,AT,T
	Frequency: 10 MHz Stability: $> 1 \times 10^{-10}$ /yr	HP 5061A	P,A
Synthesized Sweeper (used as Local Oscillator in P <sup>1</sup> and A <sup>1</sup> , and Sweep Generator in A <sup>1</sup> )	Frequency range: 10 MHz to 20 GHz Must have External Time Base Input Frequency Accuracy: Same as Time Base Accuracy RF Power Output: $\geq +9$ dBm	HP 8341A* or HP 8340A**	P,AT,A

\*Instruments equipped with both Option 001 and 004 are not recommended

\*\*Option 004 instrument is not recommended

Table 1-2. Recommended Test Equipment (2 of 5)

Instrument	Critical Specifications	Recommended Model	Use <sup>1</sup>
Signal Generator	Frequency: 300 to 400 MHz RF Output Power: $\geq 0$ dBm Resolution: $\pm 50$ kHz	HP 8654A, HP 8340A or HP 8341A	A
Desktop Computer	Equipped with 750K memory Substitute: (Used only for HP-IB Operation Verification; HP 85F. Includes HP 83936A ROM Drawer, HP 82937A HP-IB Interface, and I/O ROM HP Part No. 00085-15003.)	HP 9836A/26A HP 85F	HP-IB, AT HP-IB
Plotter/Printer ROM	For HP 85F, no substitute.	HP Part No. 00085-15002	HP-IB
Printer	Must have graphics capability	HP 2671G	AT
Automated Test Procedures Software	No Substitute (Includes five programmed discs with documentation)	HP Part No. 08340-10010	AT
Modulation Analyzer	No Substitute	HP 8901A/8902A	P,AT
Pulse Generator	Pulse Width: $\leq 100$ nS Rise Time: $\leq 10$ nS Frequency: 20 Hz to 50 kHz	HP 8012B	P,A,AT,T
Function Generator	Sinewave Amplitude: $\geq 1$ Vrms Sinewave Frequency: dc to 100 kHz	HP 3325A	P,A,AT,T
Amplifier	Frequency Range: 100 kHz to 1.3 GHz Gain: $>20$ dB	HP 8447F	P,AT
Scalar Network Analyzer/Detector	Frequency Range: 10 MHz to 20 GHz Connector: APC-3.5	HP 8755C/56A HP 11664B	A
Storage Normalizer	Compatible with HP 8755C (Needed only if HP 8755C is used in adjustment procedure)	HP 8750A	A
Power Supply	0 to 50 Vdc Voltage Drift (in 1 Hour): $\leq 0.1\% + 2.5$ mV	HP 6294A	P,A,AT
Mixer	Frequency Range: 1 to 20 GHz	RHG DMS 1 - 26	P,AT,A
Feedthrough Termination	50 Ohm feedthrough	HP 10100C	P
Attenuators	Frequency Range: 0.01 to 20 GHz Maximum Input Power: $>+10$ dBm Attenuation: 10 dB Connectors: APC-3.5	HP 8493C Opt. 010	P,AT,A
	Frequency Range: 0.01 to 20 GHz Maximum Input Power: $>+10$ dBm Attenuation: 20 dB Connectors: APC-3.5	HP 8493C Opt. 020	P,AT

Table 1-2. Recommended Test Equipment (3 of 5)

Instrument	Critical Specifications	Recommended Model	Use <sup>1</sup>
Step Attenuator	Calibrated at 50 MHz 0 to 70 dB in 10 dB steps	HP 355D	AT
Directional Coupler	Frequency Range: 1.7 to 20 GHz Coupling: 16 dB Maximum Input Power: 100 mW	HP Part No. 0955-0125	A,AT
Adapters	APC-3.5 Female to Type N Male (2 required) APC-3.5 Female to Female BNC Female to Dual Banana SMB Male to SMB Male SMA Male to BNC Female APC 3.5 Male to Type N Male APC 3.5 Male to Type N Female Type N Male to BNC Female	HP Part No. 1250-1744 5061-5311 <sup>2</sup> 1251-2277 1250-0069 1250-1200 1250-1743 1250-1750 1250-1476	P,A,T,AT P,A,AT P,AT A P,A,AT P,A,AT P,A,AT P,AT
Adapter Tees	BNC Male-Female-Female SMB Male-Male-Male	HP Part No. 1250-0781 1250-0670 <sup>2</sup>	P T
Active Probe	Input Impedance: 100KOhms Output Impedance: 50 Ohms	HP 1121A	T,A
Probe Power Supply	For HP 1121A	HP 1122A	T,A
Low Pass filter	Pass 100 MHz and below Reject 150 MHz and above	HP Part No. 9135-0260	P,AT
Crystal Detector	Positive Negative	HP 8473C (Option 003) HP 8473C	P,T P,AT,T
Diode (2 required)	Peak Inverse Voltage: 400V Average Forward Current: 750 mA	HP Part No. 1901-0028	P,AT
Capacitors	1000 pF ( $\pm 10\%$ ), 100 VDC 0.1 $\mu$ F ( $\pm 10\%$ ), 200 VDC	HP Part No. 0160-4574 0160-0168	P,AT A
Resistors	1 MOhm, 1% 0.5 Watt 1 KOhm 1%, 0.25 Watt	HP Part No. 0757-0059 0757-0280	A AT
PC Board Extenders	24-pin 30-pin 36-pin 44-pin 48-pin 62-pin 110-pin	HP Part No. 08340-60095 <sup>2</sup> 08505-60041 <sup>2</sup> 08505-60042 <sup>2</sup> 08350-60031 <sup>2</sup> 08340-60050 <sup>2</sup> 08340-60096 <sup>2</sup> 08340-60033 <sup>2</sup>	T T T T T T T

Table 1-2. Recommended Test Equipment (4 of 5)

Instrument	Critical Specifications	Recommended Model	Use <sup>1</sup>
IC Test Clip	16-pin 20-pin	HP Part No. 1400-0734 <sup>2</sup> 1400-0979 <sup>2</sup>	T T
Adjustment Tool	Fits adjustment slot on components	HP Part No. 8830-0024 <sup>2</sup>	T T
Service Cables	BNC (Male) to SMB (Female) (2 required) 61mm (2 ft), 0.85 in., semi-rigid, SMA Male to SMA Male (2 required) 30 mm (12 in) SMB (Female) to SMB (Female)	HP Part No. 085680-60093 <sup>2</sup> 08340-20124 <sup>2</sup>  5061-1022 <sup>2</sup>	T P.A.T.A.T  T
Nut Driver	9/16 inch. to replace front panel BNC nuts	HP Part No. 08340-20099 <sup>2</sup>	T
Wrench	5/16-inch slotted box/open end	HP Part No. 08555-20097 <sup>2</sup>	T
Notch Filter	A least 35 dB rejection at 1 MHz Construct as shown below. The filter rejection should be:  ≥ 35 dB at 1 MHz  < 26 dB at 1.01 MHz	Locally Fabricate	P



Table 1-2. Recommended Test Equipment (5 of 5)

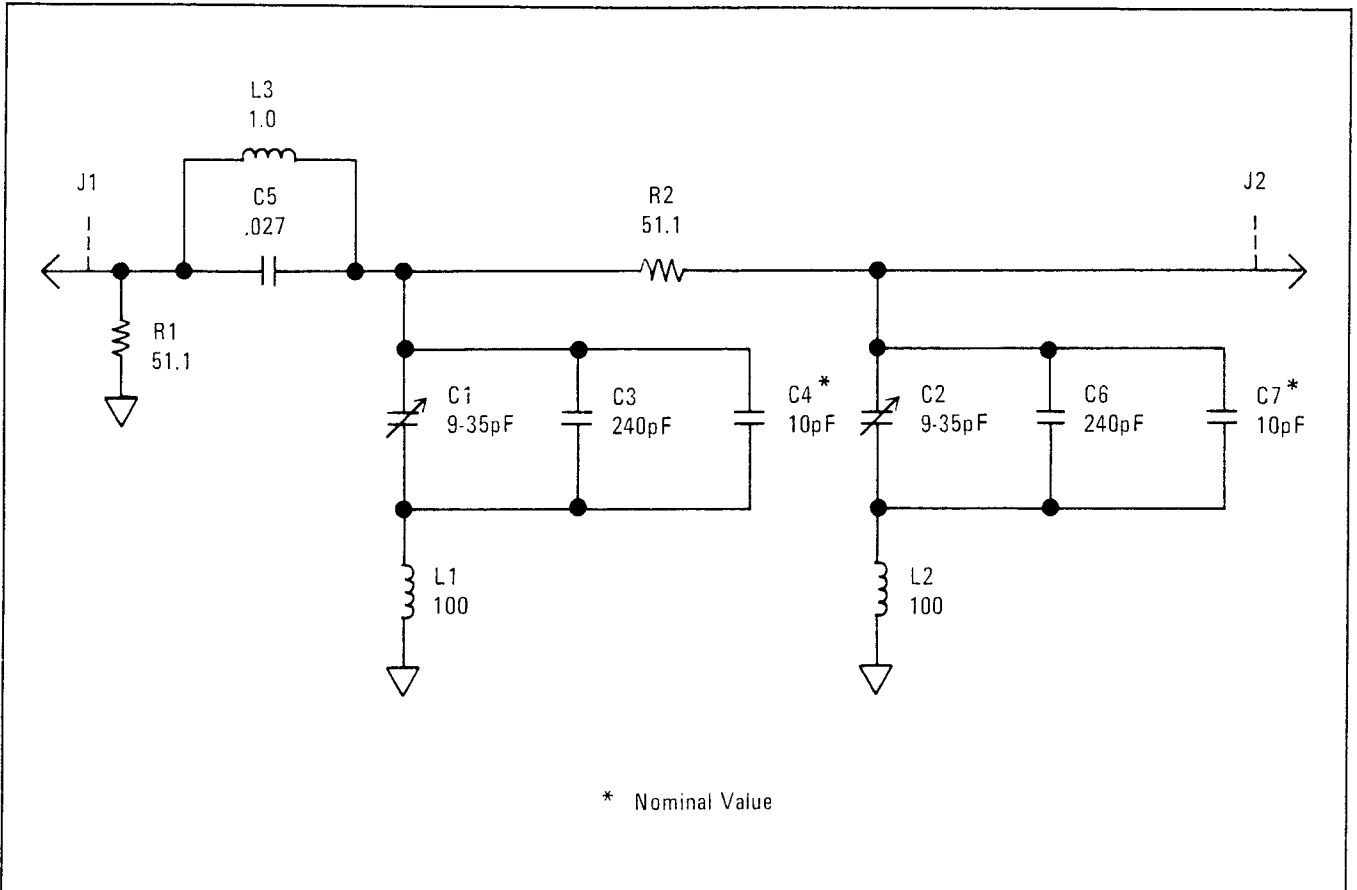

Reference Designator	Description	HP Part No.	Qty
C1.2	CAPACITOR-VAR CER 9-35PF	0121-0046	2
C3.6	CAPACITOR-MICA 240PF 300V	0140-0199	2
C4.7	CAPACITOR-CERAMIC 10 PF 100V	0160-4791	2
C5	CAPACITOR-PE .027 $\mu$ F 200V	0170-0066	1
J1.2	CONNECTOR RF FEMALE BNC	1250-0212	2
	LOCKWASHER	2190-0016	2
	NUT	2950-0001	2
L1.2	COIL 100 $\mu$ H 5%	9140-0210	2
L3	COIL 1.0 $\mu$ H 5%	9100-3551	1
R1.2	RESISTOR 51.1 1% .125W	0757-0394	2

1. P=Performance Tests, HP-IB=HP-IB Operation Verification Test, AT=Automated Tests, A=Adjustments, T=Troubleshooting. Refer to the Recommended Test Equipment text in Section I for further information on the Automated Test Procedure's equipment requirements.

2. These parts are included in Service Kit HP Part Number 08340-60134.



## SECTION II INSTALLATION

### 2-1. INTRODUCTION

2-2. This section provides installation instructions for the HP 8341A Synthesized Sweeper. This section also includes information about initial inspection, damage claims, preparation for use, packaging, storage and shipment, and Operation Verification.

### 2-3. INITIAL INSPECTION

2-4. Inspect the shipping container for damage. If the shipping container or cushioning material is damaged, it should be kept until the contents of the shipment have been checked for completeness and the instrument has been checked mechanically and electrically. The contents of the shipment should be as shown in Figure 1-1. Procedures for checking electrical performance are given in Section IV, Performance Tests, in this volume. Performance Test limits are also given in Section IV of this volume. If the instrument combination does not pass the electrical Performance Tests, refer to Section V, Adjustments, in this volume. If, after the adjustments have been made, the instrument combination still fails to meet specifications, and a circuit malfunction is suspected, refer to troubleshooting procedures in Section VIII, Service, in Volumes 3 and 4. If the instrument does not pass the above electrical tests, if the shipment contents are incomplete, or if there is mechanical damage or defect, notify the nearest Hewlett-Packard office. If the shipping container is damaged, or if the cushioning material shows signs of stress, notify the carrier as well as the Hewlett-Packard office. Keep the shipping materials for carrier's inspection. The HP office will arrange for repair or replacement without waiting for claim settlement.

### 2-5. PREPARATION FOR USE

#### 2-6. Power Requirements

2-7. The HP 8341A Synthesized Sweeper requires a power source of 100, 120, 220, or 240 Vac ( $\pm 10\%$ ), 47.5 to 66 Hz, single-phase. Power consumption is approximately 500 VA (40 VA in STANDBY).

### 2-8. Line Voltage and Fuse Selection

#### CAUTION

**To prevent damage to the instrument, make the correct line voltage and fuse selection before connecting line power to the instrument.**

2-9. Figure 2-1 illustrates the line voltage selection card and fuse location in the power line module on the rear panel of the HP 8341A. Select the line voltage and fuse rating as follows:

- Measure the ac line voltage available.
- Refer to Table 2-1. Select the correct position of the printed circuit line voltage selection card (shown in Figure 2-1) by matching the measured ac line value to the correct range indicated in the table. Note that the line voltage ranges given are within  $\pm 10\%$  of the voltage indicated on the printed circuit card. If it is not, you must use an autotransformer between the power source and the HP 8341A to match the ac line input to one of the available ranges.
- Install the printed circuit line voltage selector card in the power line module as shown in Figure 2-1.
- Select the proper fuse to install. The fuse ratings are indicated in Table 2-1 as well as next to the power line module on the rear panel of the instrument.

### 2-10. Power Cable

2-11. In accordance with international safety standards, this instrument is equipped with a three-wire power cable. When connected to an appropriate power line outlet, this cable grounds the instrument cabinet. Table 2-2 shows the styles of plugs available on power cables supplied with Hewlett-Packard instruments. The HP Part Numbers indicated are part numbers for the complete power cable/plug set. The specific type

of power cable/plug shipped with the instrument depends upon the country of shipment destination.

Table 2-1. Line Voltage/Fuse Selection

Measured ac Line Voltage	PC Selector Board Position	Fuse/HP Part Number
90 to 110 volts	100	5.0A 2110-0010
108 to 132 volts	120	4.0A 2110-0055
198 to 242 volts	220	3.0A 2110-0003
216 to 264 volts	240	2.0A 2110-0002

2-12. The offset prong of the three-prong connector is the grounding pin. The protective grounding feature may be preserved when operating the HP 8341A from a two-contact outlet by

using a three-prong to two-prong adapter and connecting the green wire of the adapter to ground. An adapter is available (for US connectors only) as HP Part Number 1251-0048.

### 2-13. HP-IB Address Selection

2-14. The HP 8341A is addressed by an instrument controller on the HP-IB bus by means of a two-digit numerical HP-IB address. This address is set at the factory to 19 but it may be reset by the user to any value between 0 and 31. The HP-IB address is displayed in the ENTRY DISPLAY window upon power up. Pressing [SHIFT] [LOCAL] will also cause the current HP-IB address of the HP 8341A to be displayed in the ENTRY DISPLAY. The HP-IB address may be changed by entering the key sequence: [SHIFT] [LOCAL] (new address value; between 0 and 31) [Hz]. For example, to set the HP-IB Address to 12, press [SHIFT] [LOCAL] [1] [2] [Hz]. The HP-IB address is retained in memory when the instrument is in STANDBY as well as when ac line power is removed from the instrument (as long as the battery on the A60 Processor assembly has the proper capacity).

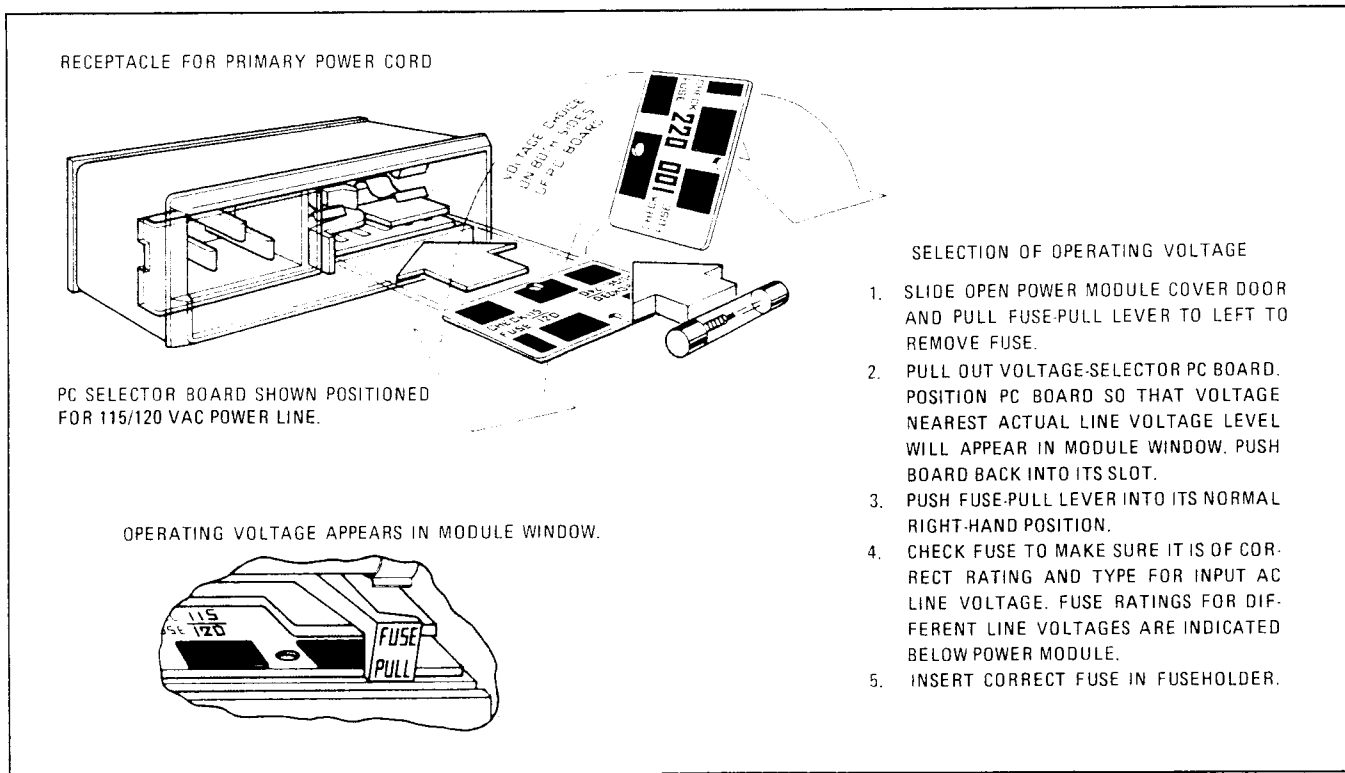
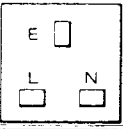
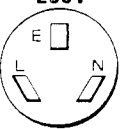
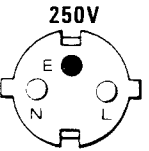
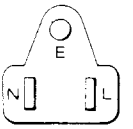

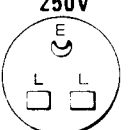
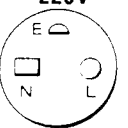
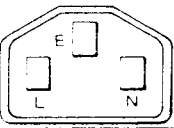

Figure 2-1. Power Line Module

Table 2-2. AC Power Cables Available

Plug Type <sup>1</sup>	Cable HP Part Number <sup>2</sup>	CD <sup>3</sup>	Plug Description <sup>2</sup>	Cable Length (inches)	Cable Color	For Use in Country
<b>250V</b> 	8120-1351 8120-1703	0 6	Straight BS1363A 90°	90 90	Mint Gray Mint Gray	United Kingdom, Cyprus, Nigeria, Zimbabwe, Singapore
<b>250V</b> 	8120-1369 8120-0696	0 4	Straight NZSS198/ASC112 90°	79 87	Gray Gray	Australia, New Zealand
<b>250V</b> 	8120-1689 8120-1692	7 2	Straight CEE7-VII 90°	79 79	Mint Gray Mint Gray	East and West Europe, Saudi Arabia, Egypt, Republic of So. Africa, India (unpolarized in many nations)
<b>125V</b> 	8120-1348 8120-1398 8120-1754 8120-1378 8120-1521 8120-1676	5 5 7 1 6 2	Straight NEMA5-15P 90° Straight NEMA5-15P Straight NEMA5-15P 90° Straight NEMA5-15P	80 80 36 80 80 36	Black Black Black Jade Gray Jade Gray Jade Gray	United States, Canada, Japan (100V or 200V), Mexico, Philippines, Taiwan
<b>250V</b> 	8120-2104	3	Straight SEV1011.1959 24507, Type 12	79	Gray	Switzerland
<b>250V</b> 	8120-0698	6	Straight NEMA6-15P			United States, Canada
<b>220V</b> 	8120-1957 8120-2956	2 3	Straight DHCK 107 90°	79 79	Gray Gray	Denmark
<b>250V</b> 	8120-1860	6	Straight CEE22-VI (System Cabinet Use)			

1. E = Earth Ground; L = Line; N = Neutral
2. Part number shown for plug is industry identifier for plug only. Number shown for cable is HP Part Number for complete cable including plug.
3. The Check Digit (CD) is a coded digit that represents the specific combination of numbers used in the HP Part Number. It should be supplied with the HP Part Number when ordering any of the power assemblies listed above, to expedite speedy delivery.

**NOTE**

An instrument address that is input by the above [SHIFT] [LOCAL] sequence is stored in a memory area referred to as "USER" memory. This address will remain in effect as long as the battery backup circuit is operating properly or until the address is changed with another [SHIFT] [LOCAL] sequence. In the event of an instrument memory problem, the value stored in "USER" may be replaced by the value "19" (a default value). If this occurs, an instrument failure may have occurred. Refer to detailed information regarding Calibration Constants in Section VIII, Service in this manual.

**2-15. Interface Function Codes**

2-16. The Interface Function Codes for the HP 8341A are an alphanumeric coded set that describes its operational capabilities on the HP-IB bus. The codes for the HP 8341A are:

SH1, AH1, T6, TE0, L4, LE0, SR1, RL1, PP0, DC1, DT1, C0, C1, C2, C3, C28, E1.

**2-17. Mating Connectors**

2-18. All of the externally mounted connectors on the HP 8341A are listed in Table 2-3. Opposite each connector is an industry identification, the HP part number of a mating connector, and the part number of an alternate source for the mating connector. For HP part numbers of the externally mounted connectors themselves, refer to Section VI, Replaceable Parts, of this manual.

**2-19. HP-IB, HP 8410, and HP 8755 INTERFACE Connectors**

2-20. Figure 2-2 shows the signal/pin configuration of the rear panel HP-IB connector. The same information is shown for the HP 8410 INTERFACE connector in Figure 2-3 and for the HP 8755C INTERFACE connector in Figure 2-4.

**2-21. Internal Oscillator Selection and Warmup Time**

2-22. The rear panel FREQUENCY STANDARD toggle switch (shown in Figure 2-5) must be in the INT position and the rear panel BNC jumper cable must be connected between the INT and EXT connectors for the instrument to operate properly when using the internal time base standard. By disconnecting the jumper from the INT connector, setting the switch to EXT, and injecting a 10 MHz signal (approximately +3 dBm, 50 Ohm nominal input impedance) from an external source, the HP 8341A can be phase locked to other instruments in a specific test setup. Sharing a common frequency reference will eliminate frequency errors between the instruments due to varying internal oscillator frequencies.

2-23. The instrument must be connected to the ac power line in order to keep the HP 8341A internal time base frequency standard oven operating at temperature. The instrument requires approximately 30 minutes to warm up from a cold start before the front panel **OVEN** annunciator goes out. Internal temperature equilibrium is reached after approximately 2 hours with a stable outside temperature. Refer to the instrument specifications in Section I, General Information, in this volume for additional information on warm up times.

**2-24. Operating Environment**

**2-25. Temperature.** The instrument may be operated in temperatures from 0°C to +55°C.

**2-26. Humidity.** The instrument may be operated in environments with humidity from 5% to 80% relative at +25°C to +40°C. However, the instrument should also be protected from temperature extremes that could cause condensation within the instrument.

**2-27. Altitude.** The instrument may be operated at pressure altitudes up to 4572 meters (approximately 15,000 feet).

**2-28. Cooling.** The HP 8341A obtains all of its cooling airflow by forced ventilation from the fan mounted on the rear panel. The cooling

Table 2-3. Model HP 8341A Mating Connectors

8340A Connector		Mating Connector	
Connector Name	Industry Identification	HP Part Number	Alternate Source
J1 SWEEP OUTPUT J2 PULSE (Opt. 006 only) J3 AM J4 EXT (Leveling) INPUT	BNC (female)	1251-0256	Speciality Connector 25-P118-1
J5 RF OUTPUT**	Type N (female)	Any industry standard Type N (male)	
J6 1V/GHz J7 SWEEP OUTPUT J8 10 MHz REF OUTPUT J9 INT J10 EXT J11 EXT TRIGGER INPUT J12 MUTE OUTPUT J13 PEN LIFT OUTPUT J14 NEG BLANK J15 Z-AXIS BLANK/MKRS J16 STOP SWP IN/OUT	BNC (female)	1251-0256	Specialty Connector 25-P118-1
J17 8755C INTERFACE*	Audio 3-Pin Connector	N/A	Switchcraft TA-3F
J18 8410 INTERFACE	25-Pin D Series	1251-0063	ITT Cannon DBM-25P
J19 AUX OUTPUT	Type N (female) (50 ohm)	Any industry standard 50 ohm Type N (male).	
J20 RF OUTPUT**	Type N (female)	Any industry standard Type N (male)	
J21 HP-IB***	24-Pin Micro Ribbon	1251-0293	Amphenol 57-30240

\* A 1219mm (48 inch) cable assembly with a Switchcraft TA-3F Audio 3-pin connector on each end is supplied with the Model 8755C Swept Amplitude Analyzer as the Alternate Sweep Interface Cable. The complete cable may be ordered separately as HP Part Number 8120-3174. The ALT SWP INTERFACE connector J17 signal/pin configuration is shown in Figure 2-4.

\*\* Options 004 and 005 only. delete J5. add J20.

\*\*\* HP-IB interface connector J21 signal/pin configuration is shown in Figure 2-2.

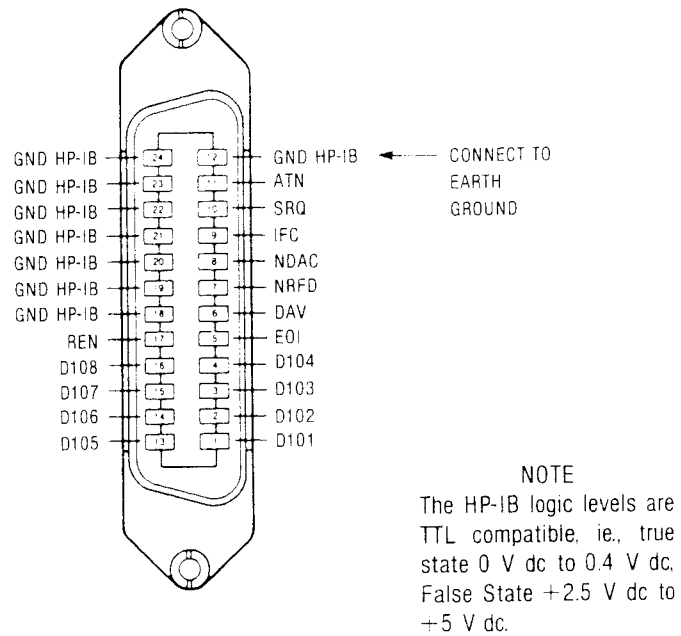

**Mnemonics Table**

Mnemonic	Description
L ATN	LOW = Attention control line
L DAV	LOW = Data Valid control line
L DIO1 thru 8	LOW = Data Input/Output control lines
L EOI	LOW = End Or Identify control line
L IFC	LOW = Interface Clear control line
L NDAC	LOW = Data Not Accepted control line
L NRFD	LOW = Not Ready For Data control line
L REN	LOW = Remote Enable control line
L SRQ	LOW = Service Request control line

Figure 2-2. HP-IB Connector Signal/Pin Configuration



**8410C INTERFACE CONNECTOR J17**  
(As seen from rear panel)

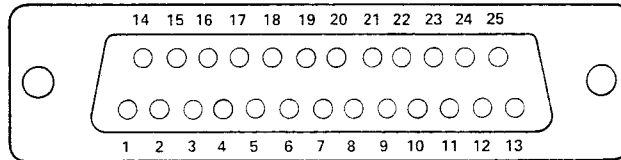

Pin	Mnemonic	Description <sup>1</sup>	In/Out <sup>2</sup>
1		No Connection	
2	Z-AXIS	LOW=Marker Pulse ( $\pm 5V$ )	Output
3		No Connection	
4	LALTSSEL	Alternate Sweep (LSTTL)	Output
5	LSSP	LOW=Stop Forward Sweep Request	Input/Output <sup>3</sup>
6	+5.2V	+5 Volts (100 mA Max.)	Output
7		No Connection	
8	MUTE	LOW=RF Blank Request (LSTTL)	Input
9	EXT TRIG	HIGH=External Trigger Sweep (LSTTL)	Input
10	PEN LIFT	HIGH=Pen Lift	Output <sup>3</sup>
11		No Connection	
12		No Connection	
13		No Connection	
14	NEG BLANK	LOW=Blanking Pulse ( $-5V$ )	Output
15		No Connection	
16	LRETRACE	LOW=Retrace Strobe (LSTTL)	Output
17	LALTEN	LOW=Alternate Sweep Enable (LSTTL)	Output
18		No Connection	
18	GND	Digital Ground/Pen Lift Return	
20		No Connection	
21		No Connection	
22	LSTEPUP	LOW=Step Advance (SW. to GND (0.4V))	Input
23		No Connection	
24	8410B TRIG	HIGH=Synchronizer Trigger (LSTTL)	Output
25		No Connection	

1. LSTTL Logic Levels. INPUTS: Low  $\leq 0.8$  Vdc, High  $\geq 2.0$  Vdc.  
OUTPUTS: Low  $\leq 0.4$  Vdc, High  $\geq 2.4$  Vdc.

2. Control of input lines can be accomplished by contact closure to ground for a logic low level and open circuit for a logic high level.

3. Open Collector Output

Figure 2-3. 8410 INTERFACE Connector Signal/Pin Configuration

ALTERNATE SWEEP INTERFACE CONNECTOR J17						
8755C ALT SWP INTERFACE  (viewed from rear of instrument)						
Pin	Mnemonic	Description	Level	Wire Color Code	A62J31 Pin	Source
1	LALTEN	LOW to Externally Enable ALT SWP Mode in HP 8755C	TTL OUTPUT	9 - 1 - 5	23	A57P1-60
2	LALTSEL	Channel Select (HIGH =Channel 1, LOW =Channel 2)	TTL OUTPUT	9 - 1 - 6	24	A57P1-59
3	LRETRACE	LOW During Retrace	TTL OUTPUT	9 - 1 - 7	25	A57P1-58

Figure 2-4. HP 8755C INTERFACE Connector Signal/Pin Configuration

airflow path is as follows: into the fan from the rear of the instrument, past the internal circuitry, and out the vents in the right side panel and the rear panel heat sink assembly.

**CAUTION**

**Ensure that all airflow passages at the rear and sides of the HP 8341A are clear before installing the instrument in its operating environment. This is especially important when using the HP 8341A in a rack mounted instrument configuration.**

**2-29. Front Handles Kit**

2-30. All standard instruments are supplied with a front handles kit. This kit must be installed by the user as illustrated in Figure 2-6.

**2-31. Chassis Slide Kit (Option 806)**

2-32. Option 806 instruments are supplied with a Chassis Slide Kit that must be installed by the user. This kit and its mounting instructions are illustrated in Figure 2-7.

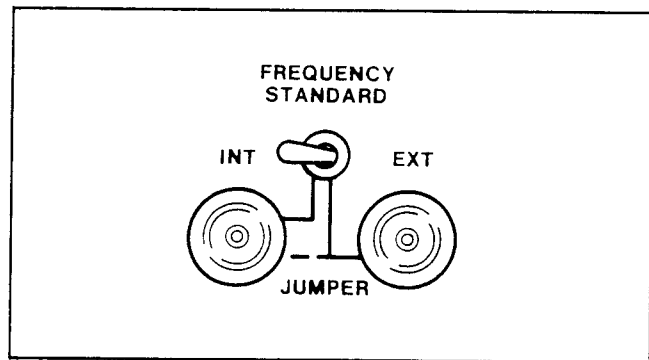

Figure 2-5. Rear Panel FREQUENCY STANDARD Switch

**2-33. Rack Flange Kit (Option 908)**

2-34. Option 908 instruments are supplied with a Rack Flange Kit. This kit includes only rack flanges; it does not include handles. Mounting instructions are illustrated in Figure 2-8.

**2-35. Rack Mounting with Handles (Option 913)**

2-36. Option 913 instruments are supplied with rack mount flanges and front handles. This kit may be installed by the user as illustrated in Figure 2-9.

**2-37. STORAGE AND SHIPMENT**

**2-38. Environment**

2-39. The instrument may be stored or shipped in environments within the following limits:

Temperature .....	-40°C to +75°C
Humidity .....	5% to 95%
	relative at 0° to +40°C
Altitude .....	Up to 15240 meters
(Pressure) .....	(approximately 50,000 feet)

2-40. The instrument should also be protected from temperature extremes that could cause condensation in the instrument.

**2-41. Packaging**

**2-42. Original Packaging.** Containers and materials identical to those used in factory packaging are available through Hewlett-Packard offices. Original packaging items are shown in Figure 2-10. The instrument front handles must be replaced by the shipping bars when the original packaging materials are used. If the instrument is being returned to Hewlett-Packard for servicing, attach a tag indicating the type of service required, return address, model number, and full serial number (located on rear panel serial plate). Mark the container **FRAGILE** to assure careful handling. In any correspondence, refer to the instrument by model number and full serial number.

**2-43. Other Packaging.** The following general instructions should be used for repackaging with commercially available packaging materials:

- a. Wrap the instrument in heavy paper or plastic. If shipping to a Hewlett-Packard Office or Service Center, attach a tag indica-

ting the type of service required, return address, model number, and full serial number.

- b. Use a strong shipping container.
- c. Use enough shock-absorbing material around all sides of the instrument to provide a firm cushion and to prevent movement inside the container. Protect the control panel with cardboard.
- d. Seal the shipping container securely.
- e. Mark the shipping container **FRAGILE** to assure careful handling.
- f. In any correspondence, refer to the instrument by model number and full serial number.

**2-44. Blue Service Tags**

2-45. Before sending the instrument back to the HP Service organization, attach a blue service tag, located at the rear of this section, to the instrument. Fill out the tag thoroughly to aid the service technician in isolating the specific fault(s) as quickly as possible.

**2-46. INCOMING INSPECTION PROCEDURE**

2-47. Several forms of an incoming inspection procedure are available in this manual. Section III, Operation, in this volume includes a section on "Getting Acquainted with the HP 8341A" that may be used to quickly verify operational functions when the instrument is first received. Section IV, Performance Tests, and the HP-IB Operation Verification procedure (also located in Section IV) should be used to verify that the instrument matches its published specifications and performance characteristics.

# FRONT HANDLE KIT

HP PART NUMBER 5061-0090

## CONTENTS

QTY.		PART NO.
2	FRONT HANDLE ASS'Y	5060-9900
2	FRONT HANDLE TRIM	5020-8897
8	=8-32 x 3/8 SCREW	2510-0195

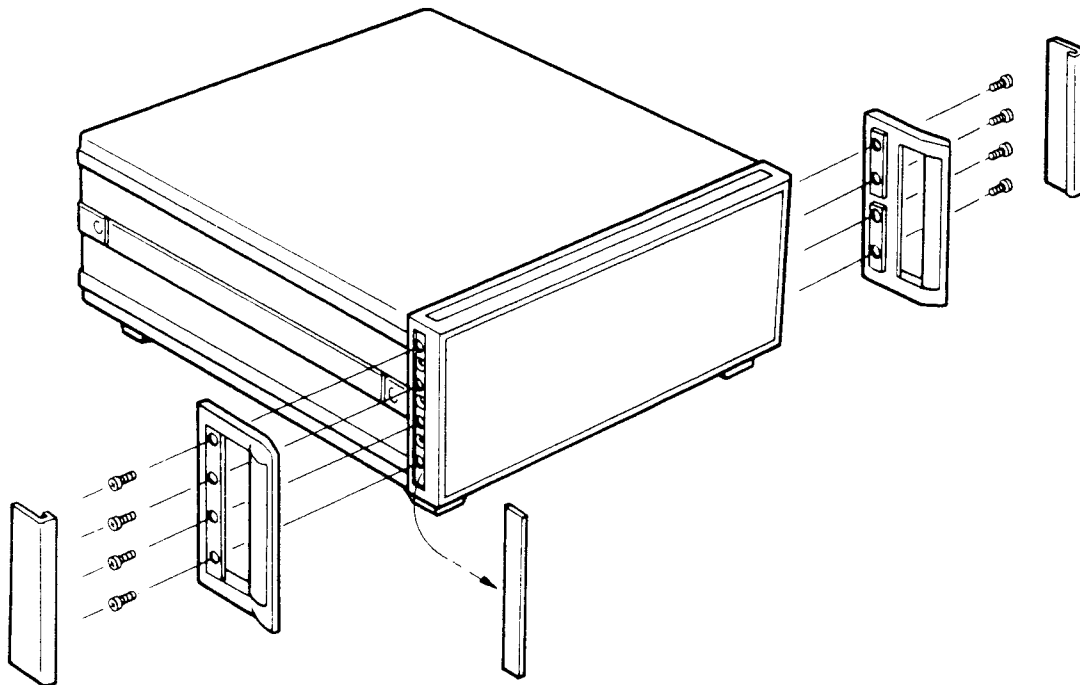

## INSTRUCTIONS

1. REMOVE SIDE TRIM STRIPS.
2. ATTACH FRONT HANDLE ASS'Y WITH 4 SCREWS PER SIDE.
3. PRESS FRONT HANDLE TRIM IN PLACE.

Figure 2-6. Mounting the Front Handles Kit

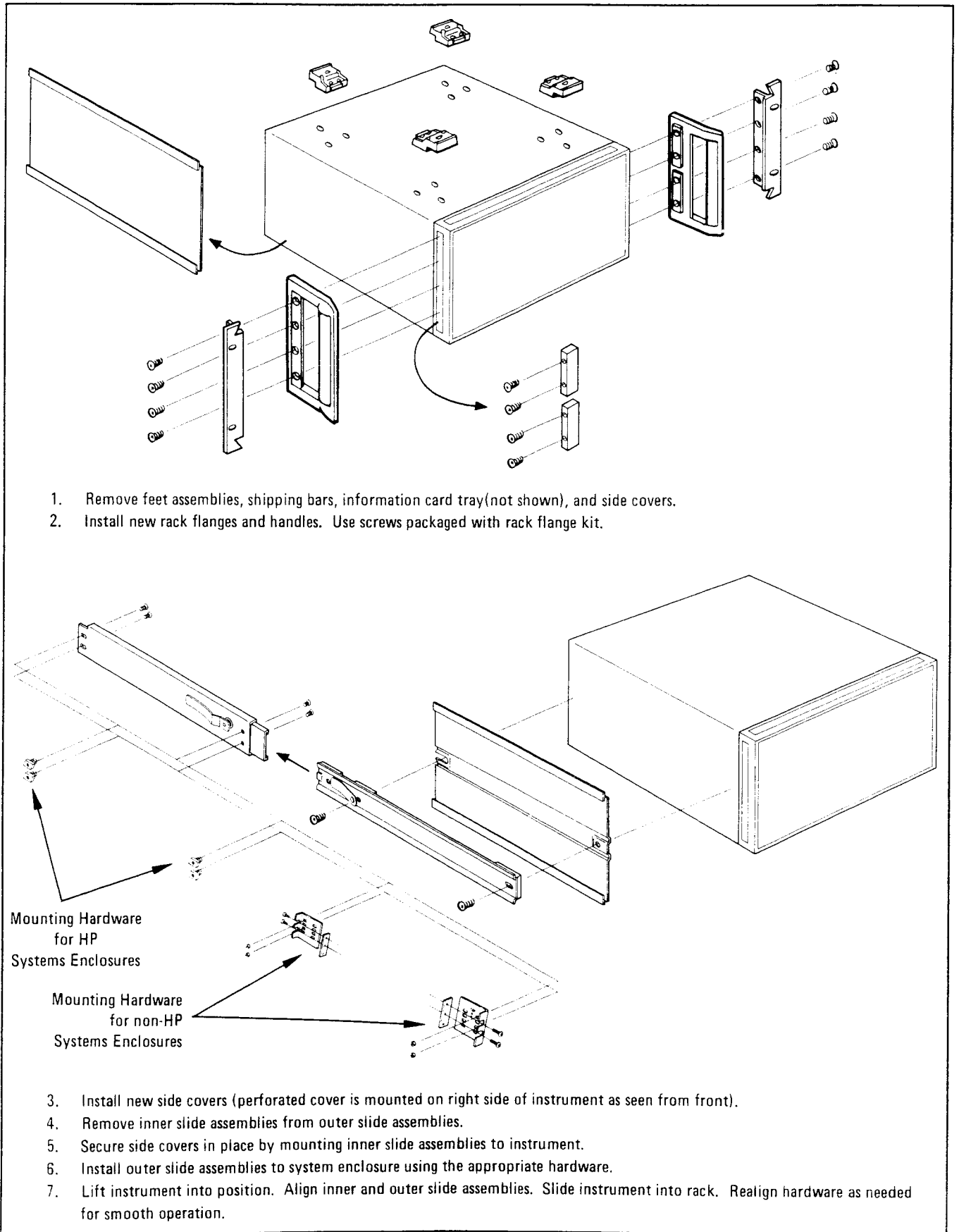

Figure 2-7. Chassis Slide Kit Mounting Instructions (Option 806) (1 of 2)

HP Part Number	Qty	CD	Description
5061-2072	1	5	Rack Mount Kit (Includes the following parts)
5020-8875	2	2	RACK MOUNT FLANGE
2510-0194	8	8	SCREW-MACH 8-32 .625-IN-LG PAN-HD-POZI
5061-0090	1	3	Handles Kit (Refer to Figure 2-6)
5060-9884	1	9	SIDE COVER – LEFT
5060-9942	1	0	SIDE COVER – RIGHT (PERFORATED)
1494-0017	1	7	Slide Kit (HP Systems Enclosures) (Includes the following parts)
1494-0017	1	7	MODIFIED SLIDE ASSEMBLY (Includes Inner and Outer Slides)
2510-0105	4	1	SCREW-MACH 8-32 .438-IN-LG PAN-HD-POZI
2510-0104	4	0	SCREW-MACH 8-32 .438-IN-LG 100 DEG
0590-0818	8	9	NUT-CHANNEL 8-32-THD .406-WD STL
2680-0143	4	6	SCREW-MACH 10-32 .562-IN-LG PAN-HD-POZI
1494-0023	1	5	Slide Adapter Kit (NON-HP Systems Enclosures) (Includes the following parts)
1494-0023	2	5	ADAPTER BRACKETS
--	4	--	BAR NUTS 10-32
2680-0103	8	8	SCREW-MACH 10-32 .5-IN-LG PAN-HD-POZI
2580-0003	8	5	NUT-HEX-W/LKWR 8-32-THD .125-IN-THK
2510-0100	4	6	SCREW-MACH 8-32 .312-IN-LG 100 DEG
2510-0101	4	7	SCREW-MACH 8-32 .312-IN-LG PAN-HD-POZI
All above parts may be ordered as the Chassis Slide Kit, HP Part Number 08340-60136.			

Figure 2-7. Chassis Slide Kit Mounting Instructions (Option 806) (2 of 2)

# RACK MOUNT KIT WITHOUT FRONT HANDLES

HP PART NUMBER 5061-0078 (OPTION 908)

## CONTENTS

QTY.		PART NO.
2	RACK MOUNT FLANGE	5020-8863
8	#8-32 x 3/8 SCREW	2510-0193

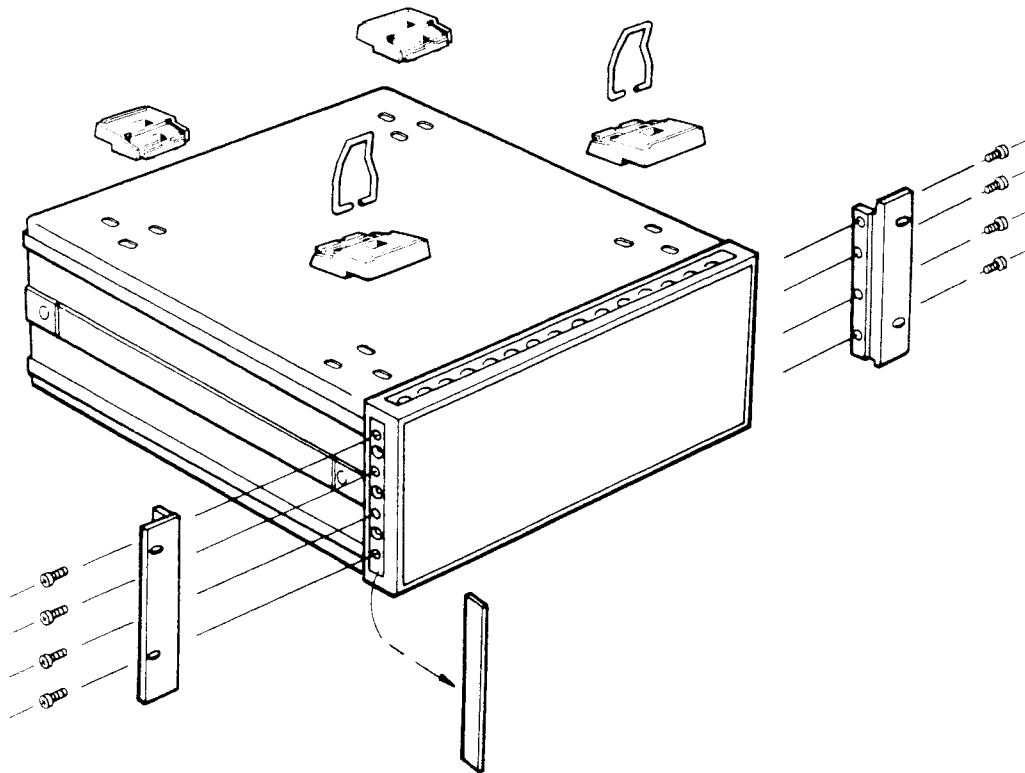

## INSTRUCTIONS

1. REMOVE SIDE TRIM STRIPS.
2. ATTACH RACK MOUNT FLANGE WITH 4 SCREWS PER SIDE.
3. REMOVE FEET AND TILT STANDS BEFORE RACK MOUNTING.

Figure 2-8. Rack Flange Kit Mounting Instructions (Option 908)

# RACK MOUNT KIT FOR CABINETS WITH PREVIOUSLY ATTACHED FRONT HANDLES

HP PART NUMBER 5061-2072 (OPTION 913)

## CONTENTS

QTY.		PART NO.
2	..... RACK MOUNT FLANGE .....	5020-8875
8	..... #8-32 x 5/8 SCREW .....	2510-0194

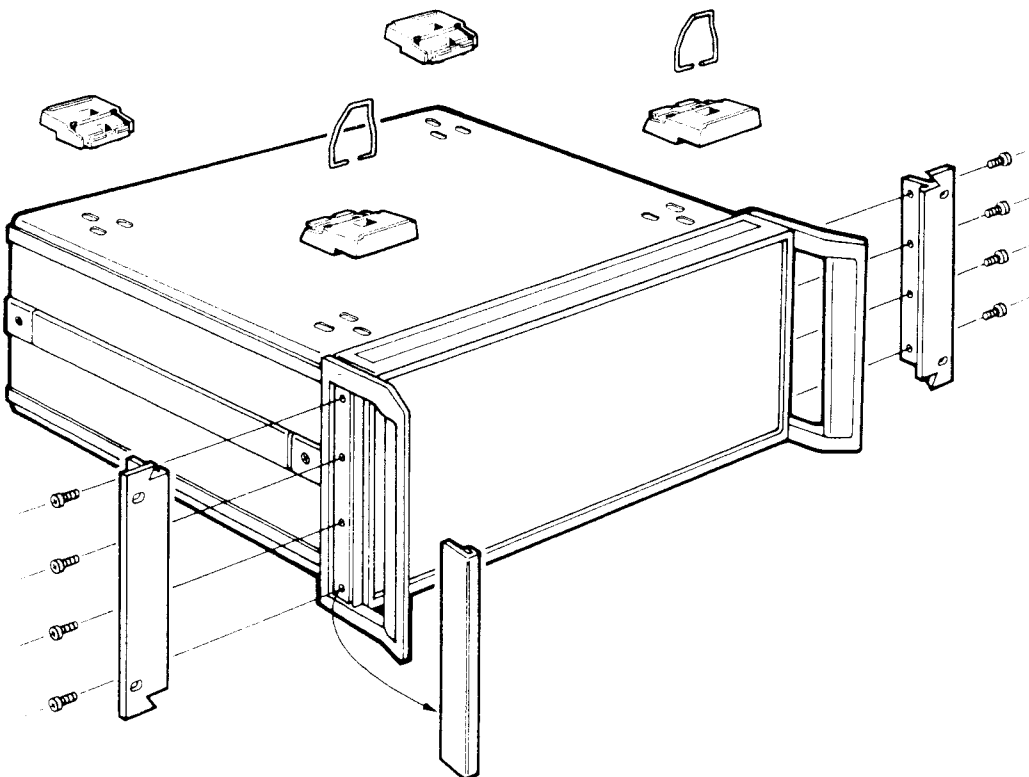

## INSTRUCTIONS

1. REMOVE SIDE TRIM STRIPS.
2. REMOVE 4 SCREWS PER SIDE.
3. ATTACH RACK MOUNT FLANGE AND FRONT HANDLE ASS'Y WITH 4 NEW LONGER SCREWS PER SIDE.
4. REMOVE FEET AND TILT STANDS BEFORE RACK MOUNTING.

Figure 2-9. Rack Mounting Kit with Handles (Option 913)



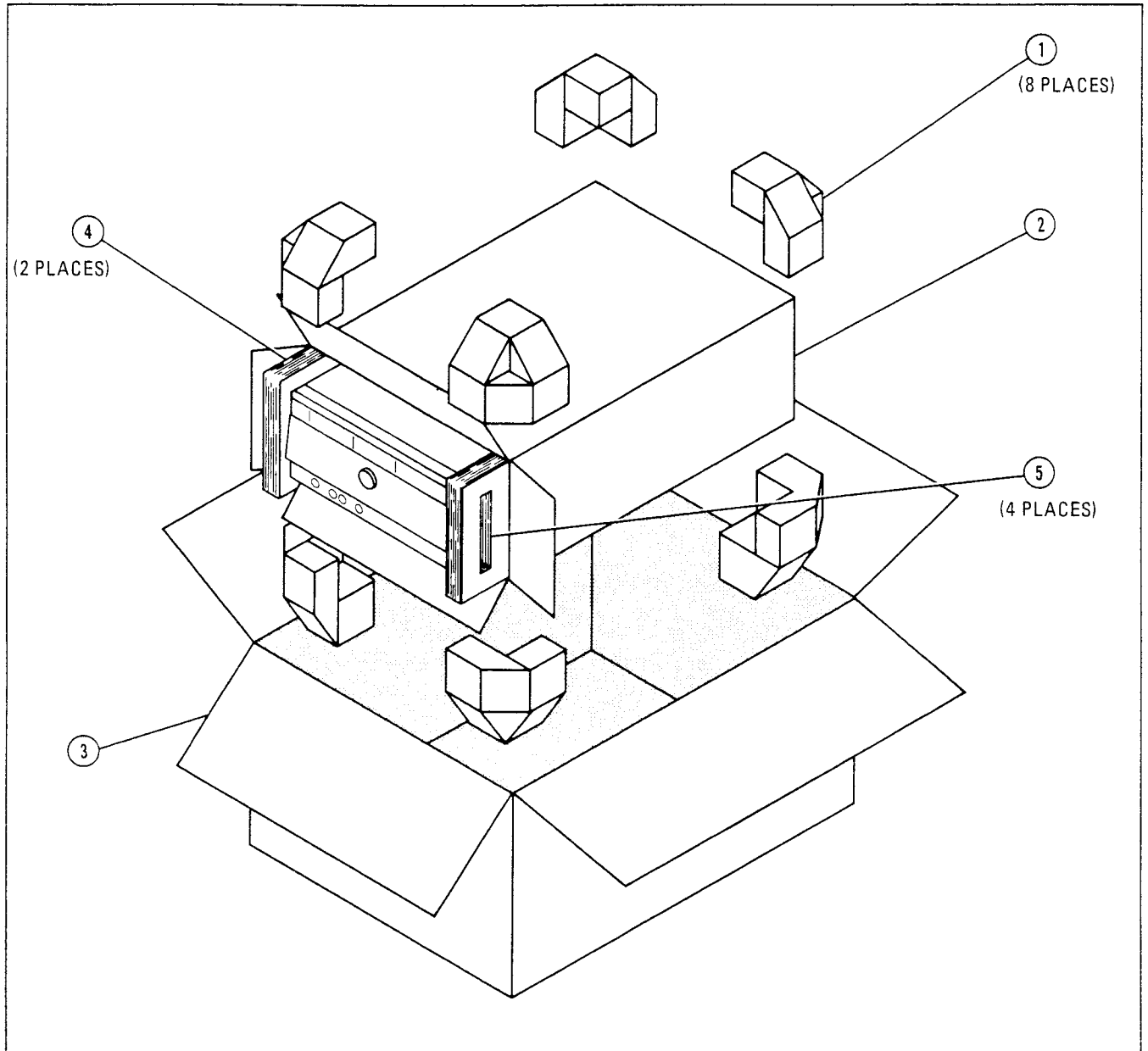

Item	Qty	HP Part No.	C D	Description
1	8	9220-2733	7	FOAM PADS – TOP CORNERS; BOTTOM CORNERS
2	1	9211-4369	2	CARTON – INNER
3	1	9211-4370	3	CARTON – OUTER
3	1	9220-4060	7	SIDE PADS – CORRUGATED CARDBOARD
–	1	9222-0069	2	POLY BAG – TO COVER INSTRUMENT (NOT SHOWN)
5	4	4040-1738	3	SHIPPING BARS
–	8	2510-0101	7	SCREW – #8-32x.312 PAN HD (TO MOUNT SHIPPING BARS)

Figure 2-10. Packaging for Shipment using Factory Packaging Materials



# Getting Acquainted with the HP 8340A Synthesized Sweeper

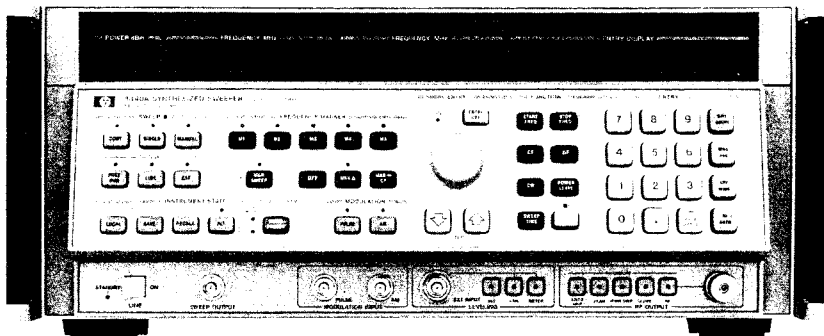

## INTRODUCTION

Anyone preparing to use the HP 8340A for the first time should begin by reading this "Getting Acquainted" guide. This guide introduces the basic procedures needed for local (front panel), and remote (computerized) operation of the instrument. An HP 8340A, a computer, and an HP-IB interface cable are all that is required to use this Getting Acquainted guide.

This guide doesn't have any detailed explanations — that is saved for Section III of the HP 8340A Operating and Service Manual. Instead, this guide

is designed as a hands-on introduction to the HP 8340A: press the buttons, program the computer, and watch the displays.

Most of the common operations of the HP 8340A are covered in this guide. The additional, in-depth explanations contained in Section III and the various Operating Guides will be easier to understand after you have completed this introductory material.

The first step in getting started is to check the line power module, as described in the following section.



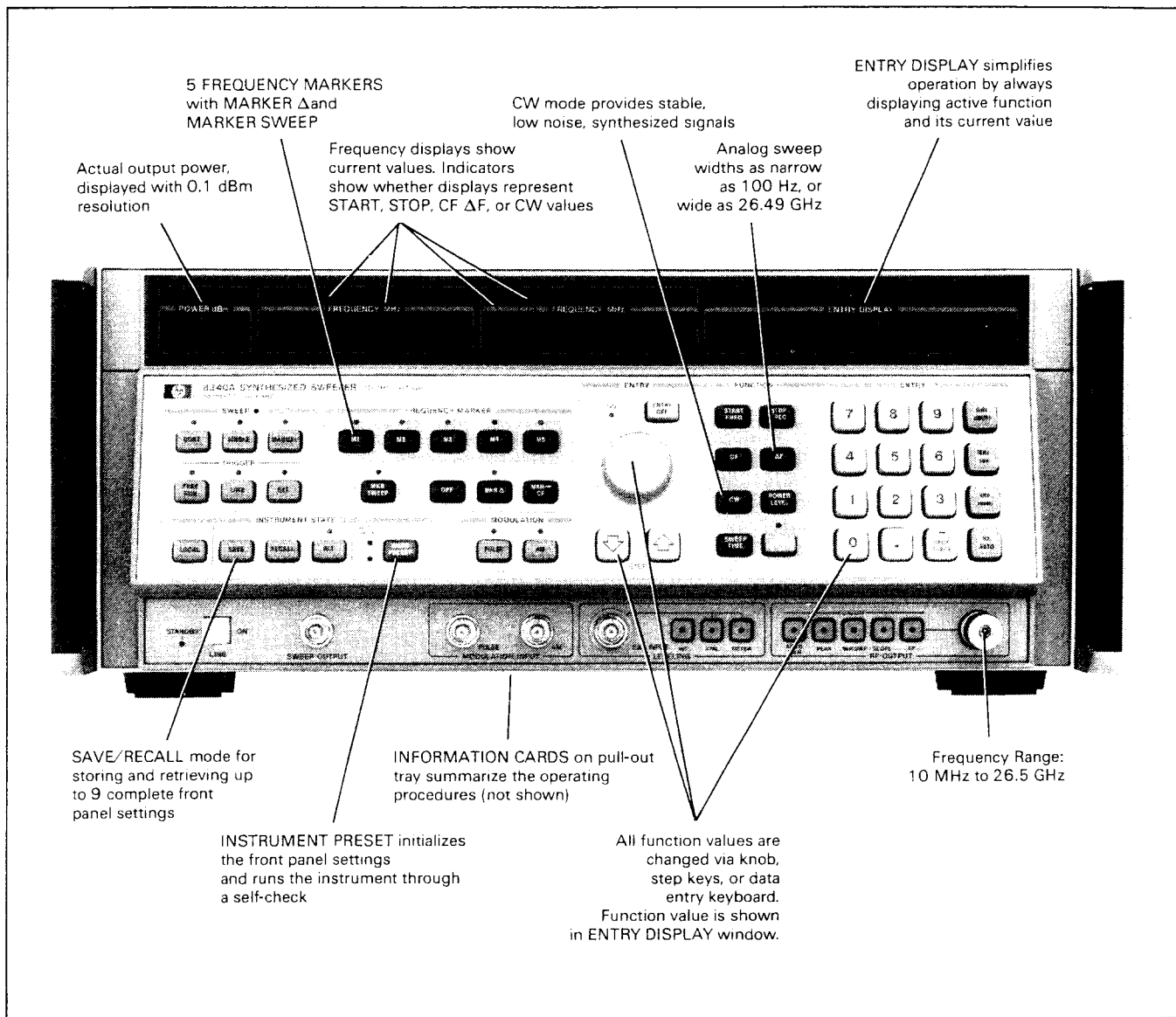

## POWER-ON PROCEDURE

If the HP 8340A has just been unpacked, the line-power module located on the rear panel of the instrument must be checked for the proper fuse rating and the correct positioning of the voltage-selector PC board, as shown in the accompanying illustration.

After checking the line-power module, attach the ac power cord and apply power to the instrument. Flip the front-panel  switch from STANDBY to ON. Notice that the red OVEN and UNLK (unlocked) annunciators are being displayed in the upper right hand corner of the ENTRY DISPLAY.

One or both of these annunciators will remain on until the crystal oven reaches operating temperature, which will require 5 – 30 minutes from a cold start. When the  switch is in STANDBY, the crystal oven remains at operating temperature; therefore, do not unplug the HP 8340A after it has been installed in its work area.

Although the HP 8340A will not fully meet specifications while the OVEN or UNLK annunciators are on, some preliminary checks can be done. These preliminary checks are described in the following Local Operation section.

RECEPTACLE FOR PRIMARY POWER CORD

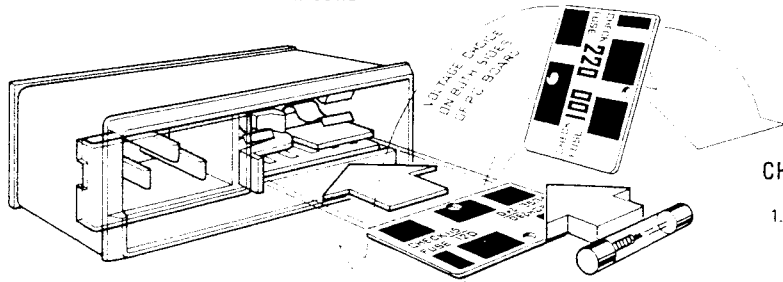

PC SELECTOR BOARD SHOWN POSITIONED FOR 115/120 VAC POWER LINE.

OPERATING VOLTAGE APPEARS IN MODULE WINDOW.

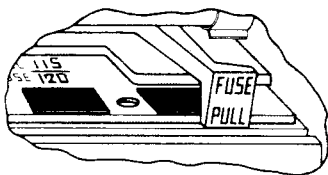

#### CHECKING THE LINE POWER MODULE

1. SLIDE OPEN POWER MODULE COVER DOOR AND PULL FUSE-PULL LEVER TO LEFT TO REMOVE FUSE.
2. PULL OUT VOLTAGE-SELECTOR PC BOARD. POSITION PC BOARD SO THAT VOLTAGE NEAREST ACTUAL LINE VOLTAGE LEVEL WILL APPEAR IN MODULE WINDOW. PUSH BOARD BACK INTO ITS SLOT.
3. PUSH FUSE-PULL LEVER INTO ITS NORMAL RIGHT-HAND POSITION.
4. CHECK FUSE TO MAKE SURE IT IS OF CORRECT RATING AND TYPE FOR INPUT AC LINE VOLTAGE. FUSE RATINGS FOR DIFFERENT LINE VOLTAGES ARE INDICATED BELOW POWER MODULE.
5. INSERT CORRECT FUSE IN FUSEHOLDER.

### LOCAL OPERATION OF THE HP 8340A SYNTHESIZED SWEEPER

Local operation is also called front-panel operation, because the desired HP 8340A functions are initiated by pressing front-panel keys. The first keys to press are those that cause an internal check of the instrument, as described below.

#### PRELIMINARY CHECKS

Press and hold the **TEST** key. Notice the red, green, and amber (yellow) LEDs and annunciators: Amber indicates which keys or functions are presently active; the single green LED indicates when the HP 8340A is sweeping (on when sweeping, off during retrace and band-crossings); and red indicates trouble. If any red LED or annunciator turns on (such as OVEN or UNLK seen at cold power-on), refer to the HP 8340A Operating and Service Manual for further instructions.

Release the **TEST** key, and observe the standard starting conditions: sweeping from 10 MHz to 26.5 GHz, at 0.0 dBm. Press **TEST** at any time to achieve this standard condition, including those times you may need a "panic" button to unscramble all of those keystrokes that you experimentally entered.

The displays are blank during the **TEST** check. To check the displays, press **TEST**, then the **TEST** key, which will cause every segment of every display element to light followed by a marching display of the entire character set.

To return to standard starting conditions, press either **TEST**, or **TEST** then **TEST** which will turn off this or any other diagnostic display. A

listing of the other diagnostic functions is contained in the HP 8340A Information Cards.

#### INFORMATION CARDS

Located below the front panel are information cards that contain a summary of the local and remote commands of the HP 8340A. Slide the cards from their tray, and observe the format of the information: The key-shaped symbols indicate the front-panel keys that are pressed in local operation, the letters and numbers next to the key-shaped symbols are the programming commands used in remote operation, and an explanation of the function follows the symbols and commands.

Under SHIFT KEY FUNCTIONS on the lower information card, find **TEST** which is the keystroke sequence you just used to activate the display self test. Notice that there are several other built-in diagnostic functions. For example, press **TEST**, then **TEST** which will display the condition of the internal oscillators (a flashing display indicates an unlocked oscillator; this diagnostic is usually called when the UNLK annunciator is lighted).

Feel free to try any of the functions described on the information cards. The HP 8340A will not be damaged if any keys are pressed in an incorrect sequence. Press **TEST** at any time to return to standard starting conditions.

#### CW OPERATION

CW operation is one of the major applications of the HP 8340A, and is easy to implement using front-panel keys. In the CW mode, the HP 8340A outputs a single, low-noise, synthesized frequency.

SHIFT, FREERUN  
Starts display self test.  
SHIFT, M5  
Cancels diagnostic functions.

KNOB, STEP keys control active function. ENTRY DISPLAY shows active function.

STEP KEY sensitivity:  
1. Press SHIFT,CF.  
2. Enter value.  
3. Select frequency unit.  
4. Press CW to return to CW mode.

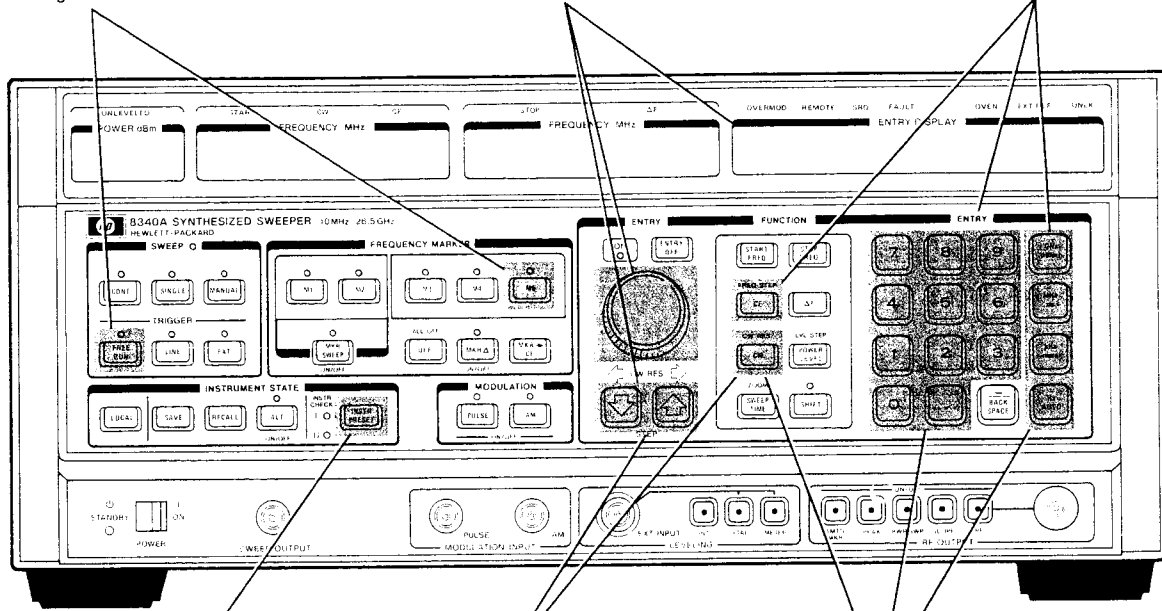

INSTRUMENT PRESET  
Restores standard conditions.

KNOB sensitivity:  
1. Press SHIFT, CW.  
2. Use CW RES keys to change sensitivity.  
3. Press CW to return to CW mode.

CW Operation:  
1. Press CW.  
2. Enter value.  
3. Select frequency unit.

To get the desired CW frequency, press **[CW]**, then use the numeric keypad to enter your desired CW frequency, followed by the frequency unit (GHz, MHz). The frequency units (GHz, MHz, KHz, Hz) are on keys located to the right of the numeric keys. Try this example:



Check the ENTRY DISPLAY in the upper right hand corner of the instrument, and the left FREQUENCY MHz display, which will both show **CW: 12 345.123456 MHz** (the ENTRY DISPLAY always shows the most recently changed function, which in this case is the CW frequency). Notice that this microwave signal has a resolution at the Hz level!

Try other CW frequencies in the 10 MHz to 26.5 GHz range. As you will see below, the CW frequency can be "tweaked" by using the **[UP]** keys and the **[DOWN]**, but first save this CW configuration for future recall. Press **[SAVE]**, then **[RECALL]** to save this CW instrument configuration in memory register 1.

## STEP KEYS, KNOB

The **[STEP]** keys and the **[RES]** affect the function that is currently being displayed in the ENTRY DISPLAY window. When you were entering CW frequencies in the last example, your keystrokes were being displayed in the ENTRY DISPLAY window and you could have used the **[STEP]** keys or **[RES]** to control the CW frequency as well.

For example, enter the following:



The ENTRY DISPLAY will show this value in MHz. Now alternately press the up-arrow and down-arrow **[UP]** keys while watching the frequency change in the ENTRY DISPLAY window. Press and hold one of the **[UP]** keys for a repeat action.

Next, alternately rotate the **[KNOB]** clockwise and counter-clockwise while watching the changing CW frequency in the ENTRY DISPLAY. The **[KNOB]** is



SINGLE sweeps  
Started when this key is pressed.

Power Level Step Size (STEP keys increment):

1. Press SHIFT, POWER LEVEL.
2. Enter value.
3. Press dB(m).

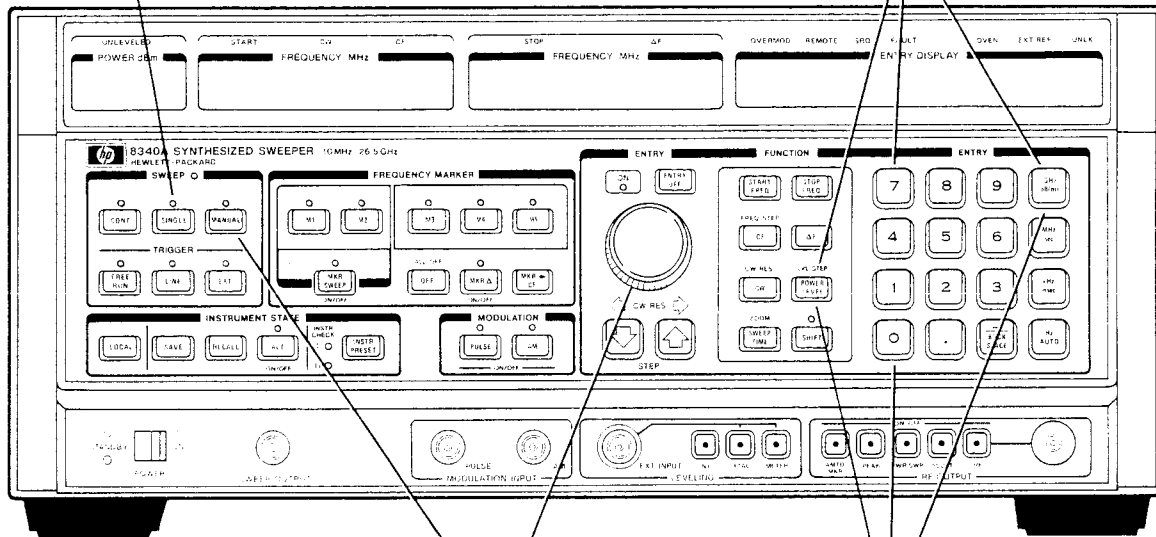

MANUAL sweeps  
Controlled by the rotary KNOB.

POWER LEVEL:  
1. Press POWER LEVEL.  
2. Enter value.  
3. Press dB(m).

Next, rotate the **MANUAL** key as you watch the ALC value change. The range is  $-20$  dBm for the lowest value, to an upper value that depends on frequency (see the specifications; the specified upper value is  $+10$  dBm at  $12$  GHz). The maximum effective upper value is determined by watching the POWER dBm display (which shows the ATN + ALC sum) as you increase the ALC value: The red UNLEVELED annunciator will light when you exceed the maximum value. The maximum range of your power sweep equals the maximum leveled range of the ALC, with the ATN providing a fixed offset.

Set the ALC to  $-15$  dBm for this example, using the **POWER LEVEL** key or the numeric keys (with the **TERMINATOR** key). The POWER dBm display will show  $-55$  ( $-40$  ATN plus  $-15$  ALC), and the power sweep range can be at least  $25$  dB (ALC range of  $-15$  to  $+10$  dB).

The rest is easy. Press **START**, and the ENTRY DISPLAY will display  $0.00$  dB/SWP. Use the **STOP** key, or the **MANUAL** key, or the numerical keys (with the

**TERMINATOR** key) to change this to the desired sweep range. For this example, press



and the HP 8340A will power sweep from  $-55$  dBm to  $-30$  dBm, in a  $10$  second period.

Before leaving the power sweep function, there are two more keys you should try. Press **STOP** to change from CONTINUOUS sweeps to single sweeps, which start every time you press the **START** key (if you press **START** in the middle of a sweep, the sweep will stop). Next, press **MANUAL** which will allow you to use the **MANUAL** key to manually sweep through the  $-55$  to  $-30$  dBm range.

Press **POWER LEVEL** again to turn power sweep off, and press **TERMINATOR** to re-couple the ATN and ALC. Swept frequency operation is explained in the next section.



## SWEPT OPERATION

The HP 8340A can sweep a frequency span as large as 26.49 GHz (10 MHz to 26.5 GHz range), or as small as 100 Hz, with 5 frequency markers available to you in the sweep span.

In this Getting Acquainted section, you will be introduced first to establishing swept operation using start/stop frequencies and center/Δ frequencies, followed by marker operations.

### START/STOP SWEPT OPERATION

The HP 8340A will sweep from a selected start frequency to a selected stop frequency. To begin, press the **START/STOP** key, then enter the numerical value of your desired start frequency, followed by the appropriate frequency unit (GHz, MHz); for example:

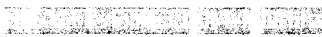

Then, press the **STOP** key, enter your desired stop frequency followed by the frequency unit; for example:

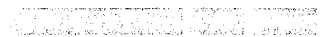

The left FREQUENCY MHz display will show your start frequency, while the middle FREQUENCY MHz display (and ENTRY DISPLAY) will show your stop frequency.

Next, adjust the sweep time. In typical applications the sweep time can vary tremendously — from milliseconds in a network analyzer system to more than a minute in thermistor-based power meter systems. However, the sweep time adjustment procedure is the same: Press the **SWEEP TIME** key, then a numerical value followed by **SEC** or **MSEC**. If the fastest possible sweep time is desired, press **FAST** followed by **SWEEP**. For example, enter the following:

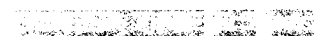

Watch the green LED next to the SWEEP label, which will blink every 2.5 seconds. The LED will blink at each retrace, and at each bandcrossing for wideband sweeps (although you aren't crossing any bands in this example). Next, press **MARKER**, then **ENTER** to obtain the fastest possible sweep speed at this frequency span (10.00 msec).

Press **SAVE**, then **2** to save this start/stop example in storage register 2 for later use.

## CENTER FREQUENCY, Δ FREQUENCY SWEPT OPERATION

This is another way of establishing Swept operation. Start/stop swept operation and center/Δ frequency swept operation are just two different ways of defining the sweep limits.

As an example of the CF/Δ F mode, press **CF/Δ F**, a numerical value for the desired center frequency, and the frequency unit (GHz, MHz); for practice try:



Then press the **SPAN** key, a numerical value for the span frequency, and the frequency unit; for example:



The HP 8340A is now sweeping from 3.5 — 4.5 GHz. The left FREQUENCY MHz display shows your center frequency, while the middle FREQUENCY MHz display (and the ENTRY DISPLAY) shows your delta frequency.

While **CF/Δ F** is the active function (presently being displayed in ENTRY DISPLAY), try the **START/STOP** and **SPAN** keys and watch the changing frequency. This symmetrical expansion of the frequency span about the center frequency is one reason that CF/Δ F swept mode is sometimes used instead of start/stop frequency sweeps. Next, you will add markers to the sweep field.

Press **SAVE**, then **1** to save this instrument configuration for future recall.

### FREQUENCY MARKERS

The HP 8340A has 5 frequency markers that can be used as fixed frequency “landmarks”, or as variable frequency pointers on a CRT display. Your introduction to frequency markers will be made by continuing with the previous swept frequency examples.

To obtain the instrument configuration used in the start/stop swept frequency example, press **RECALL** then **2**, which will recall all of the instrument settings that you previously established and SAVED in storage register 2. The HP 8340A should once again be sweeping from 144 MHz to 146 MHz, with a 10.00 msec sweep speed. Add a marker to this sweep field by pressing **MARKER**, then enter **144.000**. This causes an intensified dot to appear at that frequency on a CRT display (to obtain a “spike” at that frequency instead of the intensified dot, press **MARKER**).

**MARKERS:**

1. Press one M1-M5 key.
2. Enter value.
3. Select frequency unit.

**MARKER DELTA:**

1. Press MKR $\Delta$ .
2. Press any two markers M1-M5.
3. Read frequency difference in ENTRY DISPLAY.

**START/STOP FREQUENCY SWEEPS:**

1. Press START FREQ.
2. Enter value.
3. Press freq unit.
4. Press STOP FREQ.
5. Enter value.
6. Press freq unit.

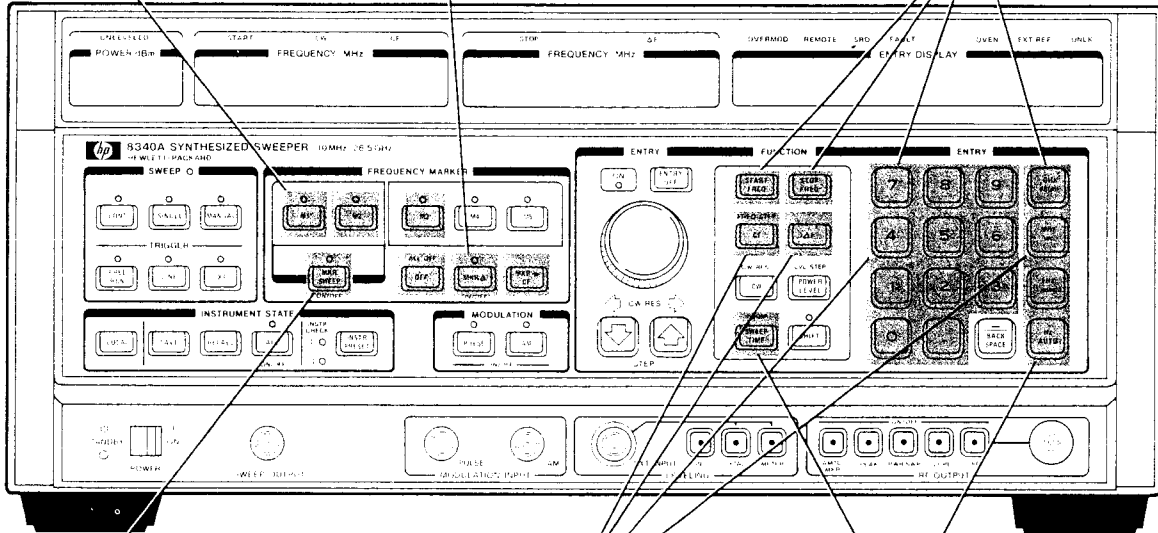

**MARKER SWEEP**

Press MKR SWEEP.  
HP 8340A will sweep between M1-M2.

**CF/ $\Delta$ F SWEEPS:**

1. Press CF.
2. Enter value.
3. Select frequency unit.
4. Press  $\Delta$  F.
5. Enter value.
6. Select frequency unit.

**SWEEP TIME:**

1. Press SWEEP TIME, then AUTO to get fastest possible sweep.
- or
1. Press SWEEP TIME.
2. Enter value.
3. Press sec or msec.

For a second marker, press **M2**, then enter **100.000**. This process can be continued for all 5 markers. Note that the marker presently being displayed in the ENTRY DISPLAY window is "active" and as such can be controlled by the numerical keyboard, **ENTER**, **DEL**, and **UNIT** keys; pressing any marker key will make that marker the active one.

As an example of the marker delta **M1-M2** function, press **M1**, enter **100.000**, and press **M2**. **M1-M2** causes the frequency difference between any two markers to be displayed in the ENTRY DISPLAY window, and the CRT trace is intensified between the two markers. Select the two markers by pressing any two marker keys. For example, press **M1**, then **M2**, and finally **M1-M2** and watch the ENTRY DISPLAY for the frequency

differences. Press **M1-M2** again to turn off the **M1-M2** function. **M1-M2** is a useful aid in examining CRT traces as for example, in measuring the 3 dB bandwidth of a bandpass filter on a network analyzer display.

Once the **M1** and **M2** markers have been established, the Marker Sweep function will change the start/stop frequencies originally established to the frequencies of these two markers. This can serve as a "magnification" function that you can use to focus in on a selected portion of the CRT trace. As an example, press **M1-M2**, which will change the start/stop sweep frequencies to the frequencies of markers **M1** and **M2** (marker sweep works only with **M1** and **M2**). Press **M1-M2** again to turn off the Marker Sweep function and return the sweep to its previous start/stop limits.

Markers are also used in exactly the same way with CF/ $\Delta$ F frequency swept mode, so at this point press **MARKER**, then **1** to recall the CF/ $\Delta$ F swept mode settings stored in register 3 to continue with the marker examples. The HP 8340A should once again be sweeping around a 4 GHz center frequency.

Markers are very easy to use, especially if you let the **MARKER** do the work for you. Try this example: Press **MARKER** and **1** to turn off all markers (so you are starting with a clean slate), then press **1**. **1** will come up with its most recent frequency; however, at the first turn of the **MARKER** the frequency of **1** will jump to the center frequency of the current sweep; that is, if **1** came up at 144.5 MHz it will jump to 4.0 GHz as soon as the **MARKER** is turned. The 4 other markers can be brought into the sweep field in the same manner.

The final example of using markers is **MARKER**, which changes the center frequency of the sweep to the frequency of one of the markers, which is another way of focusing in on a selected portion of the CRT trace. First, press one of the marker keys (the one that you want to become the center frequency) to bring that marker into the ENTRY DISPLAY. Then,

press **MARKER** to change the center frequency to the marker frequency. You can re-use the marker that just became the center frequency.

Markers are indispensable for swept frequency measurements, so practice with them until you are completely comfortable with their many features.

## RECALL INSTRUMENT CONFIGURATIONS

For the final Local Operation example, you will recall all of the instrument modes you previously created and saved (with the **SAVE** key) by using the **RECALL** key.

To recall any previously stored instrument configuration (stored by using the **SAVE** key), Press **RECALL**, then the number of the storage register (1 – 9). For example:

**RECALL 1** recalls the CW configuration used in this Getting Acquainted guide.

**RECALL 2** recalls the start/stop sweep example used in this guide.

### SAVE n

Stores instrument state in register n (1-9).

### RECALL n

Recalls instrument state previously SAVED in register n (1-9).

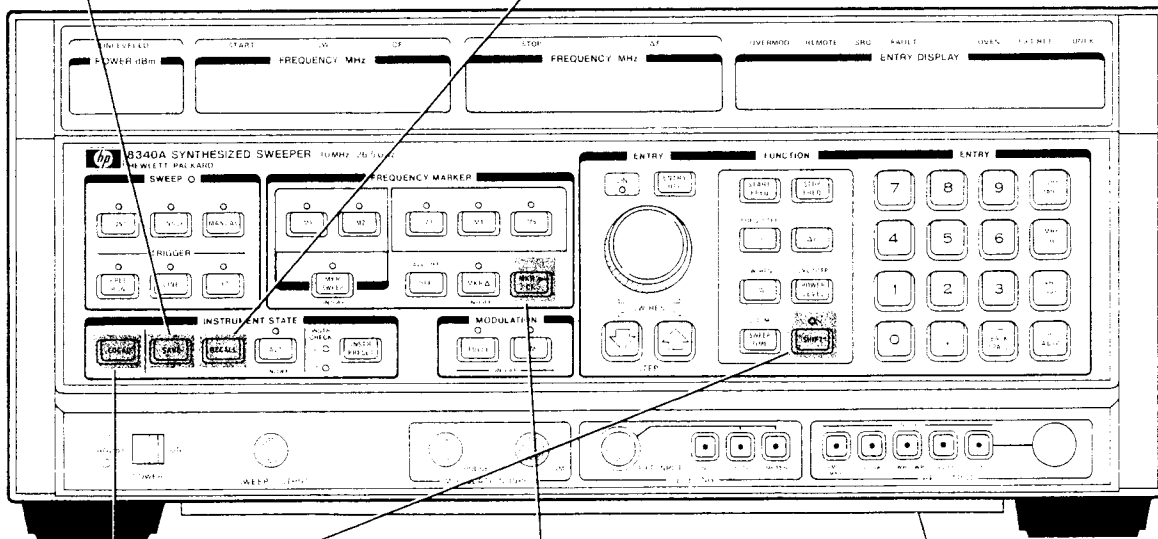

### SHIFT, LOCAL

Causes the HP-IB address to appear in the ENTRY DISPLAY.

### MKR $\rightarrow$ CF:

1. Press one marker M1-M5.

2. Press MKR  $\rightarrow$  CF.

The center sweep frequency (CF) will change to the frequency of the marker.

### Information Cards

Summarize operation procedures.

recalls the center frequency /  $\Delta$  frequency example.

**This completes** the basic introduction to local (front panel) operation of the HP 8340A Synthesized Sweeper. At this point, you are ready to study (as

needed) the advanced features of Local Operation contained in Section III of the HP 8340A Operating and Service Manual.

An introduction to remote (computerized) operation of the HP 8340A is provided in the following text.

## REMOTE OPERATION OF THE HP 8340A SYNTHESIZED SWEEPER

*HP-IB Interface Cables Available*

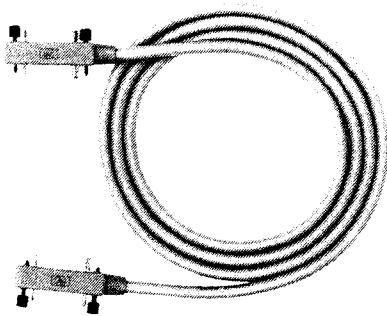

HP-IB Cable Part Numbers	Lengths
HP 10833A	1 m (3.3 ft.)
HP 10833B	2 m (6.6 ft.)
HP 10833C	4 m (13.2ft.)
HP 10833D	0.5 m (1.6 ft.)

HP-IB CONNECTION

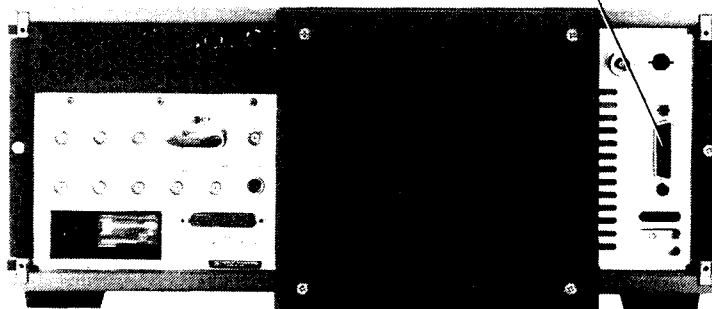

### PREPARATION FOR USE

Prepare the instruments for remote operation by connecting an HP-IB cable between the computer and the HP 8340A, and load the BASIC operating system into the computer (if necessary).

Any HP-IB computer system can control the HP 8340A; however, for simplicity only HP BASIC language commands will be used in this Getting Acquainted section. These BASIC commands are applicable to the HP 9826, 9835, 9836, 9845, and HP 80-series of computers. For other computers and other languages, consult Section III of the HP 8340A Operating and Service Manual, and the computer manuals.

Next, check the HP-IB address of the HP 8340A. If several instruments are connected to an HP-IB cable, each must have a unique address within the range of 00-30. The factory-set address for the HP 8340A is 19, which can be seen in one of two ways: Flip the  switch from STANDBY to ON, and the HP-IB address will appear (momentarily) in the ENTRY DISPLAY; or press , then  which will also cause the address to appear in the ENTRY DISPLAY.

To change the HP-IB address, press **19**, a numerical value (range 00–30), and any “terminator” key (GHz, MHz, kHz, Hz). The examples that follow use “19” as the HP 8340A address.

## PREPARATORY COMPUTER COMMANDS

HP-IB systems can be very complicated, with several instruments and lots of activity on the bus. Although your simple practice setup (one computer, one instrument) doesn't require any preparatory commands, the following 3 commands are so useful that you should become familiar with them at this time.

The “panic button” for an HP-IB system is the **ABORT** command. All activity on the bus is halted by this command:

### ABORT 7

Enter this statement on the computer, then press the computer's **7** or **ABORT** key. All HP-IB instruments (“7” directs the command to the HP-IB system) have stopped transmitting on the HP-IB and are now listening for a command from the controller (computer).

Now you want to specifically tell the HP 8340A that the computer is in command, not the front panel. To change the HP 8340A from local (front panel) control to remote HP-IB operation, enter this command:

### REMOTE 719

followed by pressing the **719** or **REMOTE** key. This command prepares the HP-IB (code “7”) instrument located at address 19 for computer control. Notice that the amber **REMOTE** annunciator above the **ENTRY DISPLAY** is now lighted. Also notice that the front panel controls on the HP 8340A no longer function, except for the **SW** switch and the **7** key (pressing the **7** key will return front panel control to the HP 8340A).

As the final preparatory command, enter

### CLEAR 719

followed by **719** or **CLEAR**, as usual. This command clears the internal status byte and extended status byte registers of the HP 8340A, so you start with a “clean slate” before beginning a program. None of the front panel annunciators change when you execute this command. This completes the preparatory commands.

At this point, any front panel function (and several special functions) can be controlled by the computer. However, only a few commands will be pre-

sented in this Getting Acquainted guide — just enough to get you started. After this introduction, you will be prepared for the additional material contained in the Programming Notes and Operating Guides contained in Section III of the HP 8340A Operating and Service Manual.

## DATA COMMANDS, OUTPUT

Data commands change the operating conditions of the HP 8340A, and are typically the most often used commands in remote applications. All front panel keystroke operations can be replaced by a data command (except for the **SW** switch). The format for outputting data commands is

### OUTPUT 719; “CODE”

for the simplest commands, or

### OUTPUT 719; “CODE DATA TERMINATOR”

for the commands that require numerical data. In both cases, the statements are followed by **719** or **DATA**. **CODE** is the characters that represent a front panel key, or a special function; all codes are listed on the lower Information Card (located below the front panel of the HP 8340A). **DATA** is the numerical value that is desired, and **TERMINATOR** is the desired unit (such as GHz, sec, dB(m), etc.). The **TERMINATOR** abbreviations are also listed on the Information Cards. Try each of the following commands as they are explained to you.

The simplest commands involve no numerical data. For example, Instrument Preset is established by this command:

### OUTPUT 719; “IP”

For shifted commands, add **SH**; for example

### OUTPUT 719; “SHT1”

starts the display self test, and

### OUTPUT 719; “SHM5”

stops the display test. A complete code-data-terminator command for establishing a 12 GHz CW output is written:

### OUTPUT 719; “CW12GZ”

The commands you have tried so far have had one command per statement; however, the commands can be strung back-to-back in the same statement. For example

### OUTPUT 719; “CW12GZPL-50DB”

causes the HP 8340A to output a 12 GHz CW signal at a power level of -50 dBm.

The HP 8340A ignores spaces and unassigned characters that are placed in a command string, and automatically upshifts lower-case letters. Therefore, both of the following commands are functionally equivalent (although the statement with spaces requires a longer execution time):

**OUTPUT 719; "FA8GZFB12GZPL0DBST500MS"**

**OUTPUT 719; "FA 8 Gz FB 12 Gz PL 0 dB  
ST 500 mS"**

The second statement is easier to read and check for errors. Looking at the Information Cards, the above statement translates to start frequency (FA) of 8 GHz, stop frequency (FB) of 12 GHz, power level (PL) of 0 dBm, and a sweep time (ST) of 500 milliseconds (mS).

There is also a command, **EK**, that is added to another code to enable KNOB control of that function on an otherwise remote front panel. For example:

**OUTPUT 719; "EKFA"** enables KNOB control of the start frequency

**OUTPUT 719; "EKFB"** enables KNOB control of the stop frequency

**OUTPUT 719; "EKPL"** enables KNOB control of the power level

This completes the introduction to sending data from the computer to the HP 8340A; but how do you send data from the HP 8340A to the computer (the reverse operation)?

## DATA COMMANDS, INPUT

A set of commands allows the computer to read HP 8340A conditions — such conditions as the start frequency, the power level, sweep times and many others. As an example, enter the following program, which will set and read the start frequency of the HP 8340A:

```
10 REMOTE 719
20 OUTPUT 719; "FA 100 Mz FB 200 Mz
   PL -50 dB"
30 OUTPUT 719; "OPFA"
40 ENTER 719; A
50 DISP A; " MHz start frequency"
60 END
```

Press **□□□□** on the computer. The HP 8340A will start sweeping at 100 MHz (FA 100 Mz), stop sweeping at 200 MHz (FB 200 Mz), at a power level of -50 dBm (PL -50 dB). The command **OPFA** in line 30 translates as "Output Interrogated Parameter" (OP) the "Start Frequency" (FA). The value of the start frequency (the interrogated parameter) is placed in a buffer, and transferred to the computer's variable A in line 40 (A is an arbitrary selection; any floating point variable can be used).

To read the stop frequency and the power level, modify the previous program from line 50 and beyond as follows:

```
50 OUTPUT 719; "OPFB"
60 ENTER 719; B
70 OUTPUT 719; "OPPL"
80 ENTER 719; C
90 DISP A; "MHz start "; B; "MHz stop "; C; "dBm
   power level"
100 END
```

Press **□□□□** and the start frequency (variable A), stop frequency (variable B), and power level (variable C) will be set by the computer and the values will be displayed on the computer's screen.

**This completes** the introduction to remote operation of the HP 8340A. Although only a few examples were presented, you will find that most of the other programming commands follow a very similar format, and they will be easy to learn after this introductory practice.

**This also completes** the Getting Acquainted guide. You should now be ready to study (as needed) the advanced features discussed in Section III of the HP 8340A Operating and Service Manual.



OPERATING INFORMATION

# HP 8341A SYNTHESIZED SWEEPER



HEWLETT  
PACKARD





## SECTION III OPERATION

### INTRODUCTION

This section completely describes all front- and rear-panel keys, connectors, switches, and displays of the HP 8341A Synthesized Sweeper, and explains all code mnemonics and the procedures used for HP-IB programming. Also described are enhancement procedures for the power control and modulation functions.

The descriptive material in the local operation subsection is organized according to the physical layout of the HP 8341A. To find specific information, use as an index either Table 3-1, or Figures 3-1 and 3-2:

Table 3-1 lists the operational modes and functions of the HP 8341A, shows the keystrokes that initiate those functions, and lists the reference figures that explain the procedures.

Figure 3-1 is a front panel drawing of the HP 8341A, with callouts indicating the reference figures that explain each key, connector, switch, and display.

Figure 3-2 is a rear panel drawing of the HP 8341A, with callouts that indicate the appropriate reference figures.

The nucleus for the HP-IB programming material is Table 3-2. Table 3-2 lists all code mnemonics and provides cross referencing to equivalent front panel keys. The codes that do not have an equivalent front panel key, along with the HP-IB programming procedures, are explained following Table 3-2.

The power control and modulation functions have several enhancement provisions. These provisions are mentioned in the relevant parts of the local operation and HP-IB programming subsections, but a collective, detailed explanation is made at the end of this Operation section.

A Table of Contents for this section follows this Introduction.

Hewlett-Packard periodically updates the operating information for the HP 8341A, in the form of a Manual Changes Supplement, and publishes a series of Operating Guides and Programming Notes. Contact the nearest HP Sales and Service office (listed inside of the back cover) to obtain this supplemental information as it becomes available.

**SECTION III  
TABLE OF CONTENTS**

INTRODUCTION ..... 3-1

**LOCAL OPERATING INFORMATION**

Figure	Page
3-1. Index by Front Panel Keys, Display and Connectors .....	3-3
3-2. Index by Rear Panel Connectors .....	3-3
3-3. Power dBm Display .....	3-7
3-4. START/CW/CF Frequency Display .....	3-9
3-5. STOP/ $\Delta$ F Frequency Display .....	3-10
3-6. Entry Display .....	3-11
3-7. Function .....	3-13
3-8. KNOB/STEP Entry .....	3-16
3-9. Frequency Marker .....	3-18
3-10. Entry .....	3-20
3-11. Sweep and Trigger .....	3-22
3-12. Instrument State .....	3-24
3-13. Power Switch. Sweep Output .....	3-26
3-14. Modulation .....	3-27
3-15. Modulation Input .....	3-28
3-16. Leveling .....	3-29
3-17. RF Output .....	3-31
3-18. Rear Panel BNC Connectors .....	3-33
3-19. Rear Panel RF Output .....	3-35
3-20. HP-IB Connector .....	3-36
3-21. HP 8410 Interface .....	3-38
3-22. HP 8755C Interface .....	3-40
3-23. Fan Assembly .....	3-41
3-24. Power Line Module .....	3-42

Table	Page
3-1. Index by Mode and Function .....	3-4

**HP-IB PROGRAMMING INFORMATION**

Introduction .....	3-43
Interconnective Cabling .....	3-43
Instrument Addresses .....	3-43
HP-IB Instruments Nomenclature .....	3-43
Programming the HP 8341A .....	3-43
HP-IB Command Statements .....	3-44
HP 8341A Programming Codes .....	3-49
Programs that Duplicate Front Panel Operations .....	3-49
Using the Rotary KNOB .....	3-54
Using Keys that Toggle ON/OFF .....	3-54
Operator's Programming Check .....	3-54
Unique HP-IB Programming Codes .....	3-55
System Timing .....	3-74
HP-IB Programming Techniques for Special Applications .....	3-75
HP-IB Pin-Out Description .....	3-75
The Twelve HP-IB Messages .....	3-79
Computer Access of HP-IB Lines .....	3-85

Sending HP-IB Messages .....	3-85
Reading HP-IB Messages .....	3-86
Direct Writing to the HP-IB Lines .....	3-88

Figure	Page
3-25. HP-IB Pin-Out .....	3-76
3-26. HP-IB Handshake Timing .....	3-77
3-27. Representative Status Registers .....	3-87
3-28. Representative Control Registers .....	3-89

Table	Page
3-2. HP 8341A Programming Codes .....	3-51
3-3. The Standard ASCII Code .....	3-83

**POWER CONTROL AND  
MODULATION INFORMATION**

INTERNAL LEVELING .....	3-91
Coupled Mode .....	3-91
Power dBm Display .....	3-91
Decoupled Mode .....	3-93
UNLEVELED MODE .....	3-95
EXTERNAL LEVELING .....	3-97
Detector Characteristics .....	3-98
POWER dBm Display used with the Attenuator (Opt. 001, 004) .....	3-98
Bandwidth .....	3-100
AMPLITUDE MODULATION .....	3-101
Power dBm Display used with AM .....	3-102
Dynamic Range .....	3-102
Bandwidth for AM Applications .....	3-102
PULSE MODULATION (Opt. 006) .....	3-103
Sample and Hold Leveling .....	3-103
Response Time .....	3-106
Unleveled Mode Used with Pulse Modulation .....	3-107
Input Characteristics .....	3-108
Pulse Envelope .....	3-108
Source Match .....	3-108
Video Feedthrough .....	3-109
FURTHER INFORMATION .....	3-109

Figure	Page
3-29. ALC Loop Block Diagram .....	3-92
3-30. Reverse Power Effects .....	3-94
3-31. Typical Unleveled Modulation Response .....	3-97
3-32. Typical External Leveling Hookup .....	3-97
3-33. Typical Crystal Detector Response at 25°C .....	3-99
3-34. Pulse Measuring System .....	3-105
3-35. Error Detection and Modulator Drive .....	3-106
3-36. Pulse Input Circuit .....	3-108
3-37. Video Feedthrough .....	3-109

Table 3-1. Index by Mode and Function (1 of 6)

Mode	Function	Keys	HP-IB Code	Reference Figure
<b>Swept/CW Frequency Selection</b>				
Start/Stop Sweep	START	[START FREQ]	FA	3-7
	STOP	[STOP FREQ]	FB	
Center Frequency/ $\Delta F$ Sweep	CF	[CF]	CF	
	$\Delta F$	[ $\Delta F$ ]	DF	
	ZOOM	[SHIFT] [SWEEP TIME]	SHST	
CW Frequency	CW	[CW]	CW	
	CW RESOLUTION	[SHIFT] [CW]	SHCW	
<b>Frequency Markers</b>				
Turn On and Set Marker Frequency	MARKER 1	[M1]	M1	3-9
	MARKER 2	[M2]	M2	
	MARKER 3	[M3]	M3	
	MARKER 4	[M4]	M4	
	MARKER 5	[M5]	M5	
Turn Off A Frequency Marker	M1 OFF	[M1] [OFF]	M1M0	
	M2 OFF	[M2] [OFF]	M2M0	
	M3 OFF	[M3] [OFF]	M3M0	
	M4 OFF	[M4] [OFF]	M4M0	
	M5 OFF	[M5] [OFF]	M5M0	
Turn Off All Markers	ALL OFF	[SHIFT] [OFF]	SHM0	
Turn On And Set Mkr $\Delta$	MKR $\Delta$ , Marker "m" Marker "n"	[MKR $\Delta$ ]	MD1	
Turn Off Mkr $\Delta$	MKR $\Delta$ OFF		MD0	
Active Marker To Center Frequency	MKR $\rightarrow$ CF	[MKR $\rightarrow$ CF]	MC	
Marker 1-2 Sweep	MKR SWEEP ON	[MKR SWEEP]	MP1	
	MKR SWEEP OFF		MP0	
Marker 1 to Start Marker 2 to Stop	M1 $\rightarrow$ START M2 $\rightarrow$ STOP	[SHIFT] [MKR SWEEP]	SHMP	
Amplitude Frequency Markers	AMPTD MKR ON	[AMTD MKR]	AK1	3-17
	AMPTD MKR OFF		AK0	



	Keys	HP-IB Code	Reference Figure
<b>Frequency Selection</b>			
	[START FREQ]	FA	3-7
	[STOP FREQ]	FB	
	[CF]	CF	
	[ΔF]	DF	
	[SHIFT] [SWEEP TIME]	SHST	
	[CW]	CW	
DN	[SHIFT] [CW]	SHCW	
<b>Marker Markers</b>			
	[M1]	M1	3-9
	[M2]	M2	
	[M3]	M3	
	[M4]	M4	
	[M5]	M5	
	[M1] [OFF]	M1M0	
	[M2] [OFF]	M2M0	
	[M3] [OFF]	M3M0	
	[M4] [OFF]	M4M0	
	[M5] [OFF]	M5M0	
	[SHIFT] [OFF]	SHM0	
	[MKR Δ]	MD1	
		MD0	
	[MKR - CF]	MC	
N	[MKR SWEEP]	MP1	
F		MP0	
	[SHIFT] [MKR SWEEP]	SHMP	
N	[AMTD MKR]	AK1	3-17
F		AK0	

Table 3-1. Index by Mode and Function (2 of 6)

Mode	Function	Keys	HP-IB Code	Reference Figure
<b>Sweep Mode, Trigger and Time</b>				
Sweep Mode	CONTINUOUS	[CONT]	S1	3-11
	SINGLE	[SINGLE]	S2 or SG	
	MANUAL FREQUENCY SWEEP	[MANUAL]	S3 or SM	
Sweep Trigger	FREE RUN	[FREE RUN]	T1	
	LINE	[LINE]	T2	
	EXTERNAL	[EXT]	T3	
Sweep Time	SWEEP TIME	[SWEEP TIME]	ST	3-7
<b>Modulation</b>				
Amplitude Modulation	AM ON	[AM]	AM1	3-14, 3-15
	AM OFF		AM0	
Pulse Modulation (Opt. 006)	PULSE MOD. ON	[PULSE]	PM1	
	PULSE MOD. OFF		PM0	
	INCREASE ALC BANDWIDTH IN PULSE MODE	[SHIFT] [AM]	SHAM	
<b>Step Size, Display, and Entry Control</b>				
Set Frequency Step Size	FREQUENCY STEP SIZE	[SHIFT] [CF]	SF or SHCF	3-7
Set Power Step Size	POWER STEP SIZE	[SHIFT] [POWER LEVEL]	SP or SHPL	
Increment Active Parameter	STEP UP ↑	[▲] (STEP KEY)	UP	3-8
Decrement Active Parameter	STEP DOWN ↓	[▼] (STEP KEY)	DN	
Numeric Display Update	RE-ENABLE DISPLAY UPDATE	[SHIFT] [CONT]	SHS1 or DU1	
X-Y Recorder Interface	ENABLE PENLIFT AT BANDCROSSING	[SHIFT] [LINE]	SHT21	3-11
	DISABLE PENLIFT AT BANDCROSSING		SHT20	

Table 3-1. Index by Mode and Function (3 of 6)

Mode	Function	Keys	HP-IB Code	Reference Figure
<b>Step Size, Display and Entry Control (Cont'd)</b>				
Fixed Function To Coupled Mode	AUTO	[Hz/AUTO]	AU	3-10
Disable Active Function	ENTRY OFF	[ENTRY OFF]	EF	3-8
Display Scale	MULTIPLICATION FACTOR	[SHIFT] [START FREQ]	SHFA	3-7
Display Offset	OFFSET FACTOR	[SHIFT] [STOP FREQ]	SHFB	
<b>Instrument State/Registers</b>				
Instrument Preset	INSTR PRESET	[INSTR PRESET]	IP	3-12
Save An Instrument State	SAVE n	[SAVE]	SV	
Recall An Instrument State	RECALL n	[RECALL]	RC	
Lock Registers	SAVE LOCK	[SHIFT] [SAVE]	SHSV	
Unlock Registers	SAVE UNLOCK	[SHIFT] [RECALL]	SHRC	
Alternate Sweep Mode	ALT ON	[ALT]	AL1	
	ALT OFF		AL0	
<b>Power Level and Control</b>				
Set Output Power Level	POWER LEVEL	[POWER LEVEL]	PL	3-7
Power Sweep Mode	POWER SWEEP ON	[PWR SWP]	PS1	3-17
	POWER SWEEP OFF		PS0	
Power Slope Mode	SLOPE ON	[SLOPE]	S11	
	SLOPE OFF		SL0	
RF Power	RF ON	[RF]	RF1	
	RF OFF		RF0	
Peak Output Power (CW Mode or Manual Sweep)	PEAK ON	[PEAK]	RP1	
	PEAK OFF		RP0	
Instantaneous Peak	FAST PEAKING	[SHIFT] [AMTD MKR]	SHAK	
Tracking Calibration	AUTO TRACKING CALIBRATION	[SHIFT] [PEAK]	SHRP	



Table 3-1. Index by Mode and Function (4 of 6)

HP-IB Code	Reference Figure	Mode	Function	Keys	HP-IB Code	Reference Figure
<b>Power Level and Control (Cont'd)</b>						
AU	3-10	Leveling Modes	INTERNAL	[INT]	A1	3-16
EF	3-8		EXTERNAL CRYSTAL	[XTAL]	A2	
SHFA	3-7		EXTERNAL POWER METER	[METER]	A3	
SHFB			DISABLE ALC TO CONTROL MODULATOR DRIVE DIRECTLY	[SHIFT] [METER]	SHA3	
IP	3-12	Independent Control of ALC and Attenuator (Opt. 001, 004)	DECOUPLE ALC AND ATTENUATOR	[SHIFT] [PWR SWP]	SHPS	3-17
SV			CONTROL EACH INDEPENDENTLY			
RC			CONTROL STEP ATTENUATOR INDEPENDENTLY	[SHIFT] [SLOPE]	SHSL or AT	
SHSV						
SHRC						
AL1						
AL0						
<b>Diagnostic Functions</b>						
PL	3-7	Display M/N and 20/30 Loop Frequencies	DISPLAY M.N. M/N FREQ., 20/30 FREQ.	[SHIFT] [M1]	SHM1	3-9
PS1	3-17	Display Band # And Y.O. Loop Frequency	DISPLAY BAND # AND Y.O. FREQ.	[SHIFT] [M2]	SHM2	
PS0		Display VCO1 And VCO2 Frequencies	DISPLAY VC01	[SHIFT] [M3]	SHM3	
SH		Front Panel Display Test	DISPLAY TEST	[SHIFT] [FREE RUN]	SHT1	3-11
SL0		Display Unlock	DISPLAY UNLOCK	[SHIFT] [EXT]	SHT3	
RF1		Display Fault Indicators	DISPLAY FAULT INDICATORS	[SHIFT] [MANUAL]	SHS3	
RF0	Band Cross Control	DISABLE BAND CROSS			SHA21	3-16
RP1		RE-ENABLE BAND CROSS	[SHIFT] [XTAL]		SHA20	
RP0	Cause Manual Band Cross	MANUAL BAND CROSS	[SHIFT] [INT]		SHA1 or BC	
HAK	Turn Off Diagnostic Display	DIAGNOSTICS OFF	[SHIFT] [MS]		SHM5	3-9

Table 3-1. Index by Mode and Function (5 of 6)

Mode	Function	Keys	HP-IB Code	Reference Figure
Read/Write to Internal Circuits	SELECT CHANNEL	[SHIFT] [GHz/dB(m)]	SHGZ	3-10
	SELECT SUBCHANNEL	[SHIFT] [MHz/sec]	SHMZ	
	WRITE DATA	[SHIFT] [KHz/msec]	SHKZ	
	READ DATA	[SHIFT] [Hz/AUTO]	SHHZ	
<b>HP-IB Functions</b>				
Status Bytes and Service Requests	CLEAR BOTH STATUS BYTES		CS	
	OUTPUT BOTH STATUS SYTES		OS	
	MASK STATUS BYTE 1		RM	
	MASK STATUS BYTE 2		RE	
Output Operating Configuration	OUTPUT LEARN STRING		OL	
	INPUT LEARN STRING		IL	
	OUTPUT MODE STRING		OM	
Output Parameters	OUTPUT ACTIVE VALUE		OA	
	OUTPUT NEXT BANDCROSS FREQUENCY		OB	
	OUTPUT COUPLED PARAMETERS		OC	
	OUTPUT DIAGNOSTICS		OD	
	OUTPUT FAULTS		OF	
	OUTPUT FIRMWARE ID		OI	
	OUTPUT LAST LOCK FREQUENCY		OK	
	OUTPUT INTERROGATED PARAMETER		OP	
	OUTPUT POWER LEVEL		OR	





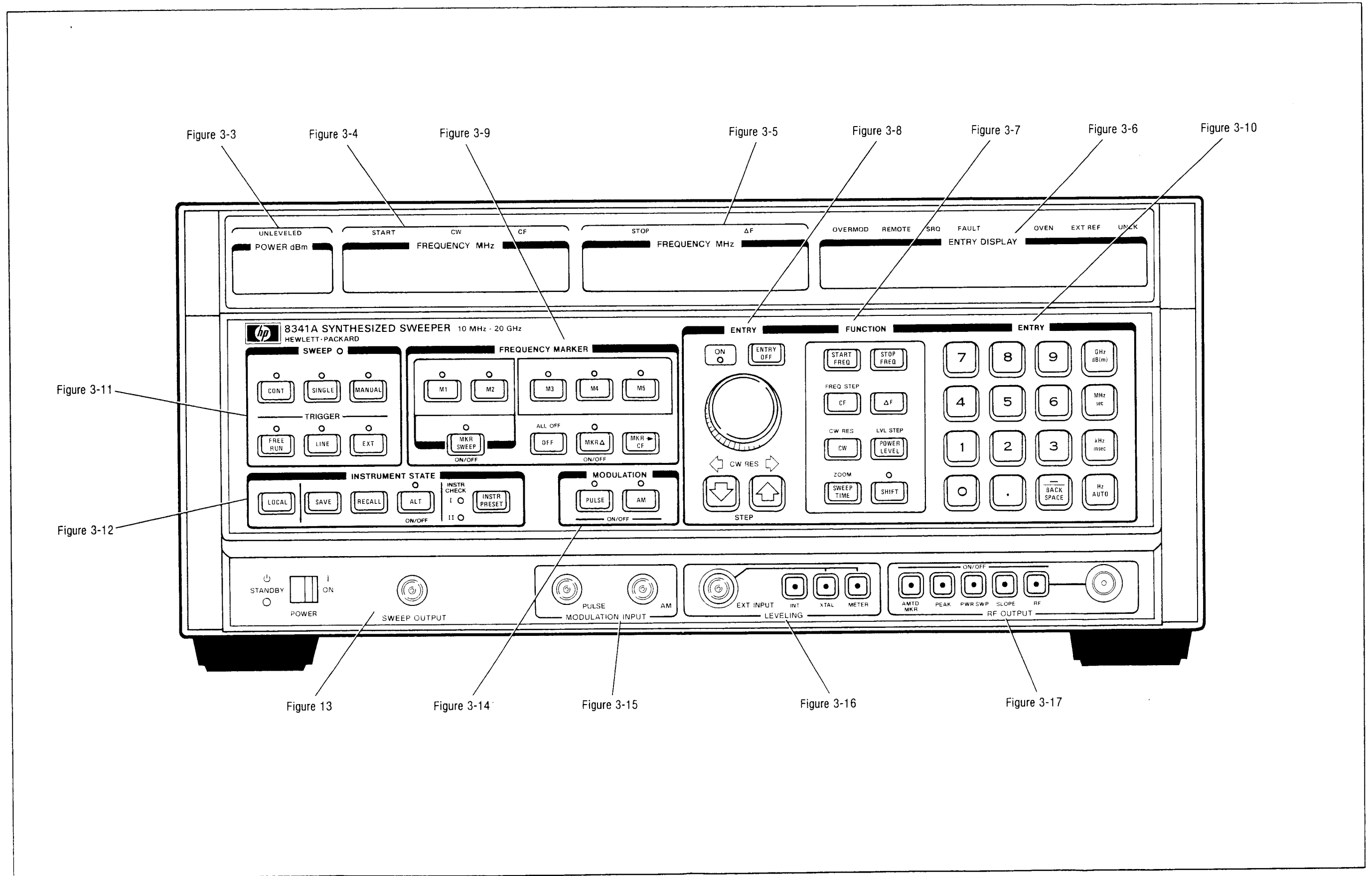

Figure 3-1. Index by Front Panel Keys, Display and Connectors



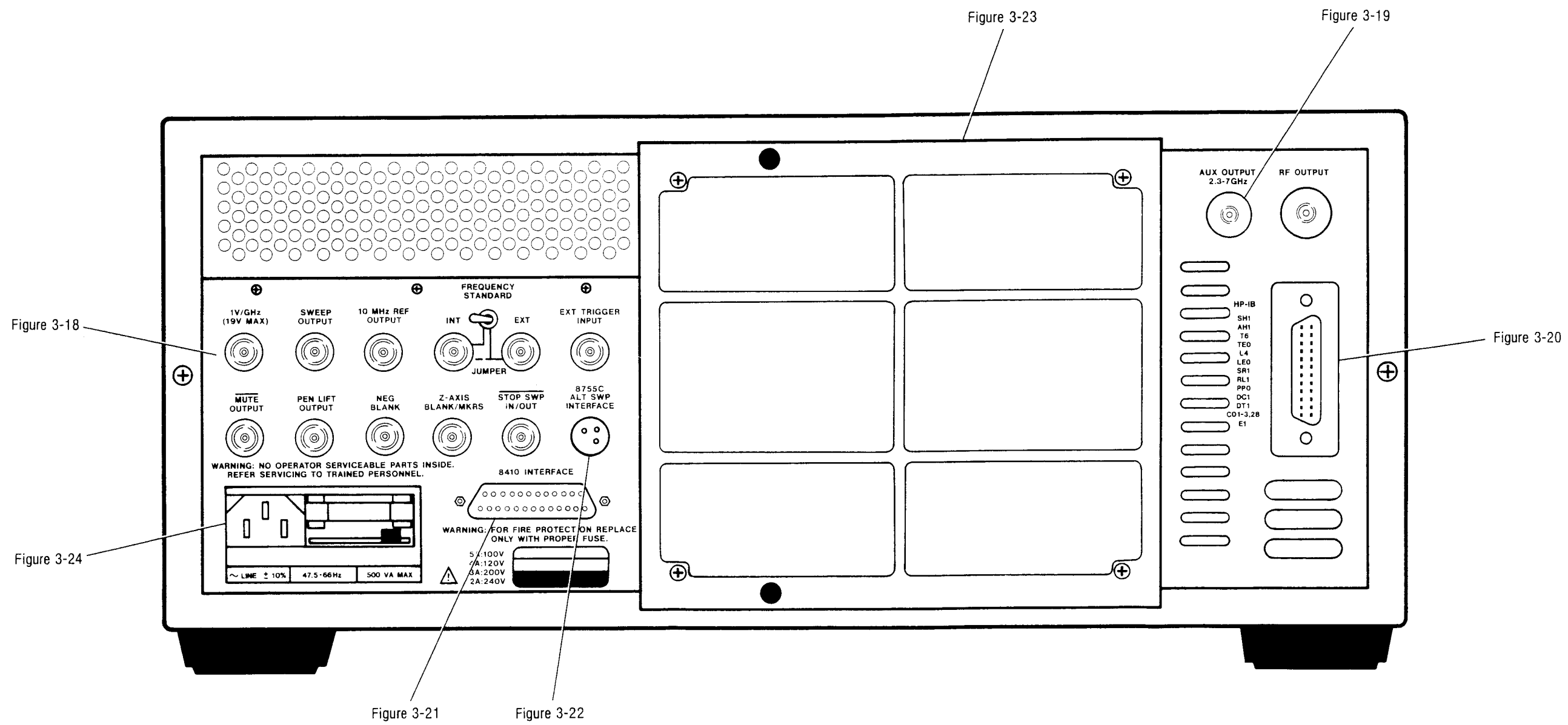

Figure 3-2. Index by Rear Panel Connectors



Table 3-1. Index by Mode and Function (6 of 6)

Mode	Function	Keys	HP-IB Code	Reference Figure
Network Analyzer Function	NETWORK ANALYZER CONFIGURE		NA	
	ADVANCE TO NEXT BANDCROSSING		BC	
	KEYBOARD RELEASE		KR	
	SWAP CHANNELS		SW	
Control Knob	ENABLE HP 8340A KNOB		EK	
	ENABLE REMOTE KNOB		RB	
Sweep Functions	STEPPED SWEEP		SN	
	INCREMENT FREQUENCY		IF	
	RESET SWEEP		RS	
	TAKE SWEEP		TS	
	TIME LIMIT		TL	
Alternate State Selection	SELECT FOREGROUND		AS0	
	SELECT BACKGROUND	AS1		
Fast Phaselock	FAST PHASELOCK SELECT	FP		
Attenuator Control	INDEPENDENT CONTROL OF ATTENUATOR	AT		
HP-IB Test	TEST HP-IB DATA TRANSMISSION	TI		



## DESCRIPTION

This display shows the actual power delivered to the RF OUTPUT port of the HP 8341A, and contains the UNLEVELED warning indicator.

## PANEL LAYOUT

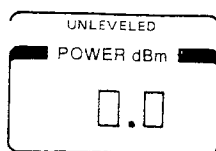

## FUNCTIONS

**POWER dBm:** The available output power of the HP 8341A is shown in this display, rounded to the nearest 0.1 dBm. Depending on the installed attenuator, (Opt. 001, 004) the available power ranges from a minimum of  $-110.00$  dBm to a maximum that depends on frequency, with a resolution of 0.05 dB (see Table 1-1 for the specified maximum power available for each frequency band). If the user requests a power level that the HP 8341A cannot provide, the instrument will select the closest available power and show that value in the POWER dBm display (to  $\pm 0.1$  dB); in this situation the ENTRY DISPLAY, which shows user-selected power level, will not match the POWER dBm display which shows actual power.

The procedures for setting the power level are explained in Figures 3-7 (POWER LEVEL) and 3-17 (POWER SWEEP, PEAKING, and RF OFF).

This display can be blanked (turned off) by pressing [SHIFT] [CONT]. Although the display is blank, the power functions can be changed by the same local and remote procedures that are used with an active display. Press [SHIFT] [CONT] to regain an active display.

## INDICATORS

**UNLEVELED:** The red UNLEVELED annunciator indicates trouble, either from operator error or machine malfunction, with one exception.

**Operator error:** request for too much power. If the operator requests a power output that is too high for the HP 8341A at that frequency, the UNLEVELED annunciator lights. Typically, the HP 8341A can deliver more power than listed in the specifications (Table 1-1); the UNLEVELED annunciator will light when the true maximum power level has just been exceeded. To remedy an UNLEVELED condition either [PEAK] the instrument (for CW or manual modes, as explained in Figure 3-17), or reduce the requested power.

**Machine malfunction:** If the UNLEVELED annunciator lights, and the cause is not a request for excessive power, one or more of the power circuits are malfunctioning. If this happens, press [INSTR PRESET] which will restore standard instrument conditions, then re-enter the desired instrument configuration. If the UNLEVELED annunciator remains lighted, shut down the instrument and consult Section VIII (Service) of this manual.

Exception: open-loop operation. The ALC can be bypassed by pressing **[SHIFT]** **[METER]**, as described in Figure 3-16. Under these conditions the UNLEVELED annunciator is lighted, but acts as a reminder in this case instead of a warning.

#### **DIAGNOSTICS**

Test this display (and the three other displays) by pressing and holding **[INSTR PRESET]**, which will cause the UNLEVELED annunciator to light, then release **[INSTR PRESET]** and press **[SHIFT]** **[FREE RUN]** which will light every segment of the LED display ("88888"). Press **[SHIFT]** **[M5]** to cancel this diagnostic test.

*Figure 3-3. Power dBm Display (2 of 2)*



## DESCRIPTION

This display shows (in megahertz) either the start frequency, the CW frequency, or the CF (center frequency) of the HP 8341A depending on its current operating mode.

## PANEL LAYOUT

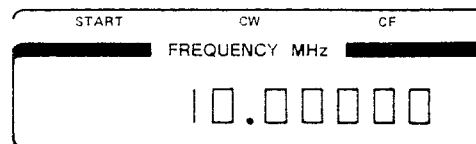

## FUNCTIONS

One of three frequencies is shown in this display: Start, CW, or CF. Figure 3-7 explains the implementation of these three functions.

This display can be blanked (turned off) by pressing **[SHIFT] [CONT]**. Although the display is blanked, the Start, CW, or CF values can be changed by the same local or remote procedures that are used when the display is active. Press **[SHIFT] [CONT]** again to turn the display on.

## INDICATORS

**START, CW, and CF:** These three amber annunciators indicate which function value is shown in the display.

## DIAGNOSTICS

Press and hold **[INSTR PRESET]** to light the three annunciators, then release **[INSTR PRESET]** and press **[SHIFT] [FREE RUN]** which will light every LED segment ("88888888888888"). Press **[SHIFT] [M5]** to end this diagnostic routine. (This same diagnostic procedure also tests the three other displays)

## DESCRIPTION

This display shows, in megahertz, either the Stop frequency or the  $\Delta F$  frequency span of the HP 8341A.

## PANEL LAYOUT

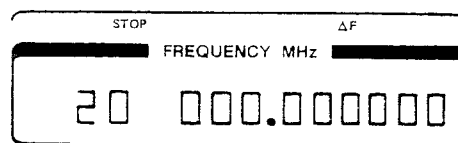

## FUNCTIONS

One of two frequencies is shown in this display: Stop, or  $\Delta F$ . Figure 3-7 explains the implementation of these two functions.

This display can be blanked (turned off) by pressing [SHIFT] [CONT]. Although the display is blanked, the Stop or  $\Delta F$  values can be changed by the same local and remote procedures that are used when the display is active. Press [SHIFT] [CONT] again to turn the display on.

## INDICATORS

**STOP,  $\Delta F$ :** These two amber annunciators indicate which function value is shown in the display.

## DIAGNOSTICS

Press and hold [INSTR PRESET] to light the two annunciators, then release [INSTR PRESET] and press [SHIFT] [FREE RUN] which will light every LED segment ("88888888888888"). Press [SHIFT] [M5] to end this diagnostic routine. (This diagnostic also tests the three other displays)

## DESCRIPTION

This display shows the active function and its present value, and contains the OVERMOD, REMOTE, SRQ, FAULT, OVEN, EXT REF, and UNLK indicators.

## PANEL LAYOUT

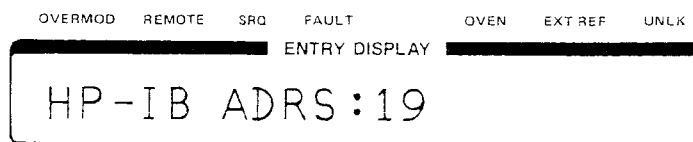

## FUNCTIONS

The most recently activated function and its present value is shown in this display. In local operation, the most recently pressed function key is the active function and will remain active until superseded by the pressing of another function key. The HP 8341A will remember (for approximately one year) the activated function even when the power is disconnected, and will display that function in the ENTRY DISPLAY when the power is turned on. The HP-IB address ("HP-IB ADRS=19") is displayed momentarily at power-on, followed by a display of the active function.

In local operation, the active function can be changed by the rotary [KNOB], the [STEP] keys, or the numerical keypad. First, press one of the function keys to make that function active and display its present value in the ENTRY DISPLAY. Then, change the value of that function by using either the [KNOB], the [STEP] keys, or the numerical keys (with a terminator key).

In remote operation, the ENTRY DISPLAY will show the last function programmed.

ENTRY DISPLAY can be blanked (turned off) by pressing [ENTRY OFF]; the display will remain blanked until one of the function keys is pressed.

ENTRY DISPLAY can also be blanked by pressing [SHIFT] [CONT], which turns off all of the displays. The displays will remain blanked even when the function keys are pressed (although the annunciators will change). To regain a live display, press [SHIFT] [CONT] again.

## INDICATORS

ENTRY DISPLAY contains two types of indicators: amber identification annunciators, and red warning annunciators.

**REMOTE** (amber) annunciator lights when the HP 8341A is being remotely controlled by a computer. When REMOTE is lighted, all front panel operations are disabled with three exceptions: The POWER switch can only be locally operated, the rotary [KNOB] can be enabled by using the EK programming code, and the [LOCAL] key will override the computer and restore local control (unless the computer sent a LOCAL LOCKOUT command to the HP 8341A, which disables the [LOCAL] key).

**FAULT** (amber) annunciator lights when one of the internal circuits performs atypically. To identify the affected circuit, press **[SHIFT] [MANUAL]** which will cause "FAULT: CAL KICK ADC PEAK TRK" to appear in the ENTRY DISPLAY. The flashing letters identify the faulty circuit as CAL (calibration constants), KICK (YO or YTM kick pulses), ADC (analog to digital converter), PEAK (power peaking), or TRK (tracking control); at this point, Section VIII (Service) of this manual should be consulted for further instructions.

**EXT REF** (amber) annunciator lights when an external frequency source is used as the reference standard instead of the internal crystal oscillator. The internal/external frequency standard is selected by a rear-panel switch; see Figure 3-18 for an explanation of this switch and the associated connectors.

**OVERMOD** (red) annunciator lights when excessive negative voltage is applied to the front-panel AM MODULATION INPUT, which causes the HP 8341A to attempt to exceed the maximum available modulation depth. This happens at approximately  $-1$  volt AM input. Positive excursions have no limit as long as maximum available power is not exceeded, at which point the UNLEVELED annunciator lights. AM linearity will suffer for inputs above  $+1$  volt. As with the UNLEVELED annunciator, an OVERMOD indication may signify an internal malfunction.

**SRQ** (amber) annunciator lights when a remotely controlled HP 8341A initiates a Service Request (SRQ does not apply to local operation). Several conditions can cause a Service Request, including altered parameter values, syntax error, power failure, and unleveled power. The SRQ annunciator remains lighted until the computer sends an acknowledgment signal to the HP 8341A. Service Requests are more fully explained in the HP-IB Programming part of this Operation chapter.

**OVEN** (red) annunciator lights when the oven for the reference crystal oscillator is not at operating temperature. A cold oven typically requires 5-30 minutes to reach operating temperature. The STANDBY position of the POWER switch maintains power to the oven heater, thus keeping the oven warm and the crystal oscillator ready for immediate operation. Although the HP 8341A can be operated with a cold crystal oscillator, the instrument might not fully comply with specifications until the proper operating temperature is achieved.

**UNLK** (red) annunciator lights when the HP 8341A's output signal is no longer phase-locked to the 10 MHz reference oscillator. Press **[SHIFT] [EXT]**, which will cause "OSC: REF M/N HET YO N2 N1" to appear in the ENTRY DISPLAY. The flashing letters indicate the oscillator that is not phase locked, which will require service as described in Section VIII (Service) of this manual.

## DIAGNOSTICS

Press and hold **[INSTR PRESET]** to light the seven annunciators, then release **[INSTR PRESET]** and press **[SHIFT] [FREE RUN]** which will light every LED segment and show the entire ENTRY DISPLAY character set. Press **[SHIFT] [M5]** to end this diagnostic routine. (This diagnostic also tests the three other displays)

## DESCRIPTION

This group of keys selects frequency mode, power level, sweep time, and associated functions.

## PANEL LAYOUT

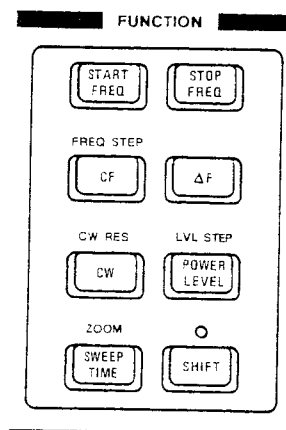

## FUNCTIONS

**[START FREQ]** (HP-IB: FA) selects the start frequency for start/stop swept operation. Press **[START FREQ]**; then use either the rotary **[KNOB]**, the **[STEP]** keys, or the numerical keys with a terminator key to set the desired value. The start frequency must be at least 100 Hz lower than the stop frequency. If there is less than 100 Hz between start/stop, or if the start frequency is greater than the stop frequency, the HP 8341A will change the start or stop frequency to achieve the required separation. The order in which start/stop is entered is not important. If start/stop mode is interchanged with CF/ $\Delta$ F mode (by pressing either of the start/stop keys and then either of the CF/ $\Delta$ F keys) the sweep limits are the same. The start frequency appears in the left FREQUENCY MHz display.

**[SHIFT] [START FREQ]** (HP-IB: SHFA) scales the frequency displays by a multiplication factor of  $-30$  to  $+30$ . This is used, for example, when a frequency doubler or tripler is connected to the RF output of the HP 8341A, and the display values are multiplied by a factor of two or three to indicate the system output frequency. Press **[SHIFT] [START FREQ]**, then enter the integer multiplication factor ( $-30$  to  $+30$ ) followed by any terminator key. The selected multiplication factor effects all frequency functions (start, stop, CF,  $\Delta$ F, markers and marker functions, and the dB/GHz slope function), but the factor is not stored in the SAVE/RECALL registers (the current factor is used when recalling those registers). Cancel the multiplication factor by pressing **[INSTR PRESET]**, or enter a multiplication factor of 1.

**[STOP FREQ]** (HP-IB: FB) selects the stop frequency for start/stop swept operation. Press **[STOP FREQ]**; then use either the rotary **[KNOB]**, the **[STEP]** keys, or the numerical keys with a terminator key to set the desired value. The restrictions that apply to **[START FREQ]** also apply to **[STOP FREQ]**. The stop frequency appears in the right FREQUENCY MHz display.

**[SHIFT] [STOP FREQ]** (HP-IB: SHFB) offsets the frequency displays by a fixed amount ranging from  $-500$  GHz to  $+500$  GHz. This is used, for example, when the RF output of the HP 8341A is connected to a mixer, and for convenience the sum or difference frequency is shown in the displays. Press **[SHIFT] [STOP FREQ]**, then enter the desired offset value ( $-500$  GHz to  $+500$  GHz) followed by any terminator key. The offset affects all frequency values (start, stop, CF, CW, and markers), but the offset cancels in difference functions such as **[ $\Delta$ F]**, **[ $\Delta$  MKR]** and the dB/GHz **[SLOPE]** function. The offset value is not stored in the SAVE/RECALL registers, but the current offset value does change the values of a recalled register. Cancel the offset by pressing **[INSTR PRESET]**, or by entering an offset value of 0.

**[CF]** (HP-IB: CF) selects the center frequency for center frequency/ delta frequency swept operation. Press **[CF]**; then use either the rotary **[KNOB]**, the **[STEP]** keys, or the numerical keys with a terminator key to set the desired value. The order in which CF/ $\Delta$ F are entered is not important. Start/stop and CF/ $\Delta$ F modes can be interchanged without changing the actual sweep limits, as described in the **[START FREQ]** paragraph. The CF value appears in the left FREQUENCY MHz display.

**[SHIFT] [CF]** (HP-IB: SHCF) selects the incremental step size for the **[STEP]** keys (the **FREQ STEP** function). The step size can be as small as 1 Hz, or as large as 10 GHz. Press **[SHIFT] [CF]**, then use either the numerical keys with a terminator key, the rotary **[KNOB]**, or the **[STEP]** keys (which step in a 1-2-5 sequence at this time) to set the desired increment. After setting the step size, "FIXD" appears in the right corner of the ENTRY DISPLAY. An alternative procedure couples the **FREQ STEP** increment size to the  $\Delta$ F frequency span: Press **[SHIFT] [CF] [AUTO]** (causing "AUTO" to appear in the ENTRY DISPLAY) and the increment size will become 1/10 of the frequency span. AUTO is the default condition after an **[INSTR PRESET]**. The step size established by the **FREQ STEP** function is the same for start/stop frequencies, CF/ $\Delta$ F frequencies, the markers, and manual sweeps. The **[STEP]** keys are explained in Figure 3-8.

**[ $\Delta$ F]** (HP-IB: DF) selects the delta frequency (frequency span) for center frequency/ delta frequency swept operation. Press **[ $\Delta$ F]**; then use either the **[STEP]** keys, the numerical keys with a terminator key, or the rotary **[KNOB]** to set the desired value. The HP 8341A will sweep from  $1/2 \Delta$ F below to  $1/2 \Delta$ F above the center frequency. The restrictions that apply to **[CF]** also apply to **[ $\Delta$ F]**. The right FREQUENCY MHz displays shows the **[ $\Delta$ F]** value.

**[SHIFT] [ $\Delta$ F]** has no effect on the HP 8341A.

**[CW]** (HP-IB: CW) selects a synthesized CW frequency. Press **[CW]**; then use either the rotary **[KNOB]**, the **[STEP]** keys, or the numerical keys with a terminator key to set the desired value. The right side of the ENTRY DISPLAY shows either "AUTO" if the **[STEP]** keys and **[KNOB]** are coupled to the  $\Delta$ F frequency span, or "FIXD" if they are not coupled (see the **[SHIFT] [CF]** and **[SHIFT] [CW]** paragraphs for an explanation). The left FREQUENCY MHz display shows the CW value.

**[SHIFT] [CW]** (HP-IB: SHCW) sets the sensitivity of the rotary **[KNOB]** (the **CW RES** function) for adjusting the CW value. Press **[CW]** to enter CW mode, and set the desired CW value as described in the preceding paragraph. Then, press **[SHIFT] [CW]** and observe the flashing cursor in the ENTRY DISPLAY, which identifies the digit presently affected by the rotary **[KNOB]**. Reposition the cursor by pressing either the left-arrow or right-arrow **[STEP]** key (the arrows are printed in blue above the **[STEP]** keys). When the cursor is positioned over the desired digit, press **[CW]** to return to CW mode. After changing the CW RES, "FIXD" appears in the right corner of the ENTRY DISPLAY. However, the CW RES can be coupled to the  $\Delta$ F frequency span ("AUTO" in the ENTRY DISPLAY) by pressing

**[SHIFT] [CW] [AUTO]**, which causes the CW RES to be 1/1000 of the frequency span, reduced to the next lowest integer power of ten (for example, a frequency span of 16 GHz corresponds to a CW RES of:  $16 \text{ GHz}/1000 = 16 \text{ MHz}$ ; 16 MHz reduced to the next lowest integer power of ten equals 10 MHz, which is the CW RES). For frequency spans less than 1000 Hz, the AUTO CW RES is 10 Hz. AUTO is the default condition for CW RES after an **[INSTR PRESET]**.

**[POWER LEVEL]** (HP-IB: PL) controls the output power level of the HP 8341A, when it is internally leveled. Press **[POWER LEVEL]**; then use either the rotary **[KNOB]**, the **[STEP]** keys, or the numerical keys with the **[dB(m)]** terminator key to set the desired value (resolution 0.05 dB). When externally leveled, **[POWER LEVEL]** selects the external detector feedback voltage to which the HP 8341A will attempt to level, with a range of +6 dBV (2.00 V) to -66 dBV (500  $\mu$ V) and a resolution of 0.1 dB. The EXT INPUT (BNC connector) accepts either positive or negative inputs. When in the **[SHIFT] [METER]** (open-loop) mode the **[POWER LEVEL]** entry controls the linear modulator, as explained in Figure 3-16. In any of these three modes, the POWER dBm display shows the output power to the nearest 0.1 dB (see Figure 3-3 for information on this display, and its UNLEVELED indicator). The output power can range from -20 dBm (-110 dBm with Option 001, 004) to a maximum value that depends on frequency (see Table 1-1 for power specifications). Figure 3-17 explains **[PEAK]**, **[PWR SWP]**, and **[SLOPE]** power functions.

**[SHIFT] [POWER LEVEL]** (HP-IB: SHPL) selects the incremental step size for the **[STEP]** keys when they are used for the power level functions (**[POWER LEVEL]**, **[PWR SWP]**, or **[SLOPE]**). This is the LVL STEP function. Press **[SHIFT] [POWER LEVEL]**; then use either the rotary **[KNOB]**, the **[STEP]** keys (which step in a 1-2-5 sequence in this mode), or the numerical keys with the **[dB(m)]** terminator key to set the desired step size. The step size can range from 0.05 dB to 50.00 dB. Consult Figures 3-3 and 3-17 for further information on power functions.

**[SWEEP TIME]** (HP-IB: ST) selects the sweep times for frequency sweeps or power sweeps (power sweep is explained in Figure 3-17). Press **[SWEEP TIME]**; then use either the **[STEP]** keys (which increment in a 1-2-5 sequence for sweep time), the rotary **[KNOB]**, or the numeric keys with the **[sec]** or **[msec]** terminator key to set the desired value. Sweep time has an allowable range of 10 msec to 200 seconds, but the fastest sweep time is constrained by the frequency span: The sweep rate cannot exceed 600 MHz/msec (for example, the full 20 GHz frequency span of the HP 8341A can be swept no faster than  $20,000/600 = 33.33 \text{ msec}$ ). The fastest possible sweep can be determined automatically: Press **[SWEEP TIME] [AUTO]** to obtain the fastest possible calibrated sweep time for any sweep span. The right-hand corner of the ENTRY DISPLAY shows "AUTO" when the sweep time is coupled to the frequency span, or "FIXD" when sweep time is independent. AUTO is the default condition after an **[INSTR PRESET]**.

**[SHIFT] [SWEEP TIME]** (HP-IB: SHST) places the HP 8341A into CF  $\Delta$ F sweep mode, with  $\Delta$ F controlled only by the **[STEP]** keys and CF controlled by either the rotary **[KNOB]** or the numerical keys (with a terminator key). This is the ZOOM function, which allows the operator to quickly zoom-in on a frequency band of interest even from very wide sweeps.

**[SHIFT]** (HP-IB: SH) activates functions that are printed in blue on the front panel, as well as special functions. All **[SHIFT]** functions are described in this Operation chapter, and are summarized on the two information cards located below the HP 8341A.

## DESCRIPTION

The rotary **[KNOB]** and **[STEP]** keys affect the function that is presently being shown in the ENTRY DISPLAY. **[ENTRY OFF]** blanks the ENTRY DISPLAY.

## PANEL LAYOUT

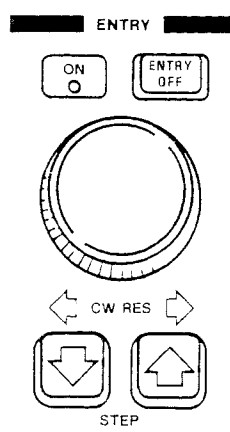

## FUNCTIONS

**[ENTRY OFF]** (HP-IB: EF) blanks (turns off) the ENTRY DISPLAY, and disables the **[STEP]** keys and the rotary **[KNOB]**. When any function key is pressed ENTRY DISPLAY is reactivated, the **ON** indicator next to **[ENTRY OFF]** lights, and the **[KNOB]** and **[STEP]** keys are enabled. To blank the ENTRY DISPLAY without disabling the **[KNOB]** or **[STEP]** keys, press **[SHIFT] [CONT]** (as described in Figure 3-6).

**[SHIFT] [ENTRY OFF]** has no effect on the HP 8341A.

**ROTARY KNOB** (HP-IB: EK) allows analog-type adjustment of the function shown in the ENTRY DISPLAY. Press any function key to activate that function, then turn the rotary **[KNOB]** to obtain the desired value. **[SHIFT] [CW]** in Figure 3-7 explains the procedure for adjusting the sensitivity of the rotary Knob. Although the **[KNOB]** has the feel of an analog control, it is actually a digital control that generates 120 pulses per revolution (the **[KNOB]** is frequently referred to as an RPG - rotary pulse generator - in service literature).

**[SHIFT] ROTARY KNOB:** **[SHIFT]** does not effect the rotary **[KNOB]**.

**STEP KEYS** (HP-IB: UP for up-increment, DN for down-increment) change the value of any active function by an incremental step. Press any function key to activate that function, then press either the up-arrow or down-arrow **[STEP]** key to incrementally change the value of that function. Press and hold a **[STEP]** key for a repeat action. The active function is always shown in the ENTRY DISPLAY. **[SHIFT] [CF]** and **[SHIFT] [POWER LEVEL]** in Figure 3-7 explain the procedures for changing the size of the increment step (although for sweep times the increment is a fixed 1-2-5 sequence). After an **[INSTR PRESET]** the step size increments default to 1/10 of the current sweep width (changing as the width changes) for the **FREQ STEP**, and to 10.00 dB for the **LVL STEP**.



**[SHIFT] STEP KEYS:** **[SHIFT]** does not effect the **[STEP]** keys; however, the **[STEP]** keys are used for the shifted CW RES function. CW RES is accomplished by pressing **[SHIFT] [CW]**, then using the **[STEP]** keys to move the cursor left or right in the ENTRY DISPLAY. **[SHIFT] [CW]** in Figure 3-7 explains the CW RES function.

#### INDICATORS

**ON** is an LED that is lighted when the **[STEP]** keys and rotary **[KNOB]** are enabled, not lighted when those controls are disabled. The preceding **[ENTRY OFF]** paragraph contains additional information about this indicator.

*Figure 3-8. KNOB/STEP Entry (2 of 2)*

## DESCRIPTION

This key group selects the five markers, the marker functions (MARKER SWEEP, MARKER DELTA, and MARKER TO CENTER FREQUENCY), and several diagnostic functions that are used during servicing.

## PANEL LAYOUT

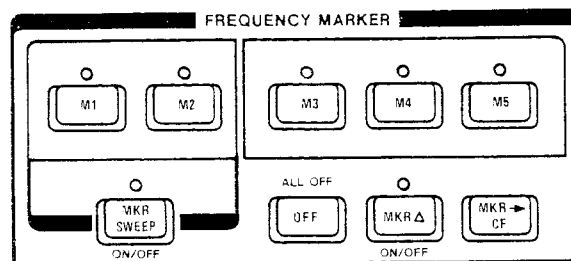

## FUNCTIONS

**[M1] ... [M5]** (HP-IB: M1 ... M5) keys select markers 1-5. Press one **[M1] ... [M5]** key, and the present value of that marker will appear in the ENTRY DISPLAY. Use either the rotary **[KNOB]**, the **[STEP]** keys, or the numerical keys with a terminator key to set the desired marker frequency. Repeat this process for the other markers as needed. If the initial marker frequency is outside of the current sweep range, a slight turn of the **[KNOB]** will bring the frequency of that marker to the center frequency of the sweep. Markers are normally displayed as z-axis intensity dots but can be changed to amplitude "dips" (an abrupt discontinuity in the sweep trace) by pressing **[AMTD MKR]**, as explained in Figure 3-17. The markers are functional whenever their individual LEDs are lighted; however, only one marker can be "active" at a time (the "active" marker is shown in the ENTRY DISPLAY, and can be changed via **[KNOB]**, **[STEP]** keys, or numerical keys with a terminator key). Press any marker key to make that marker active. After **[INSTR PRESET]** all markers are initialized to 9.995 GHz; otherwise, the last-used marker values will be remembered by the HP 8341A (for up to one year), even with disconnected ac power.

**[SHIFT] [M1]** (HP-IB: SHM1) is a service diagnostic that shows (from left to right), the M divisor, N divisor, M/N frequency, and 20/30 loop frequency. Consult Section VIII (Service) for additional information.

**[SHIFT] [M2]** (HP-IB: SHM2) is a service diagnostic that shows (from left to right), the band number and the YIG oscillator (YO) frequency. Consult Section VIII (Service) for further information.

**[SHIFT] [M3]** (HP-IB: SHM3) is a service diagnostic that shows, from left to right, the PLL #2 VCO frequency and the PLL #3 upconverter frequency. Consult Section VIII (Service) for additional information.

**[SHIFT] [M4]** (HP-IB: SH M4) initiates a possible 32 diagnostic tests and indicates the result of those tests in the ENTRY DISPLAY as either a global PASS or FAIL. PASSEd or FAILEd by entering the test number via the STEP KEYS, KEY PAD or KNOB and looking at the results in the ENTRY DISPLAY. The results of these tests can also be read over the HP-IB by using the OD command (see the HP-IB PROGRAMMING section of this Operating Information manual).

**[SHIFT] [M5]** (HP-IB: SHM5) turns off any diagnostic routine and restores the displays to their previous condition.

**[MKR SWEEP]** (HP-IB: MP1 activates the function. MP0 turns off the function) causes the HP 8341A to start sweeping at the frequency of marker **[M1]**, and stop sweeping at the frequency of marker **[M2]** (**[M2]** must have a higher frequency than **[M1]**). If **[MKR SWEEP]** is activated when **[M2]** is at a lower frequency than **[M1]**, the values of **[M1]/[M2]** will be permanently interchanged. Press **[MKR SWEEP]** again to exit from Marker Sweep and return to the previous sweep limits. The LED above the key indicates whether the function is on (lighted), or off (not lighted).

**[SHIFT] [MKR SWEEP]** (HP-IB: SHMP) causes the sweep limits to permanently change to the frequencies of **[M1]** and **[M2]**. Repeated pressing of **[MKR SWEEP]** alone causes the HP 8341A to toggle between **[M1]/[M2]** sweeps and the previous sweep frequencies; **[SHIFT] [MKR SWEEP]** eradicates the previous sweep values, leaving only the **[M1]/[M2]** frequencies.

**[OFF]** (HP-IB: M0) turns off (deactivates) any single marker. Press any marker key **[M1] . . . [M5]**, then press **[OFF]** to deactivate that marker. If **[OFF]** is pressed without first pressing a marker key, the most recently active marker will be turned off. The frequency value of the deactivated marker is retained in memory, and will be recalled when that marker key is pressed once again. A deactivated marker will not affect the **[MKR SWEEP]**, **[MKR Δ]**, or **[MKR → CF]** functions.

**[SHIFT] [OFF]** (HP-IB: SHM0) turns off (deactivates) all markers, **[M1]** through **[M5]**. However, the frequency values of all markers are retained in memory, and will be recalled when the marker keys are pressed once again. Deactivating the markers will not affect the **[MKR SWEEP]**, **[MKR Δ]**, or **[MKR → CF]** functions.

**[MKR Δ]** (HP-IB: MD1 turns on the function. MD0 turns off the function) causes the frequency difference between any two markers to appear in the ENTRY DISPLAY. Press any two marker keys **[M1] . . . [M5]**, then press **[MKR Δ]** and the ENTRY DISPLAY will show the frequency difference. Press any other marker keys **[M1] . . . [M5]**, and the ENTRY DISPLAY will change to show the frequency difference between the two most recently pressed markers. On a CRT display, the trace between the two selected markers is intensified (intensity markers only, not **[AMTD MKR]**). The LED above **[MKR Δ]** shows when the function is on (lighted), or off (not lighted).

**[SHIFT] [MKR Δ]**: SHIFT has no effect on **[MKR Δ]**.

**[MKR → CF]** (HP-IB: MC) sets the center frequency of the sweep to the frequency of the active marker. Press any marker key **[M1] . . . [M5]**, then press **[MKR → CF]** to change the center frequency of the sweep to that of the marker. The frequency span, **[ΔF]**, will not change unless the new sweep limits fall outside the frequency range of the HP 8341A; in that case, the HP 8341A will automatically scale down the **ΔF** to be within the frequency range.

**[SHIFT] [MKR → CF]** has no effect on the HP 8341A.

**DESCRIPTION**

This is the numerical keypad, with the terminator keys, that provides data entry to the HP 8341A.

**PANEL LAYOUT**

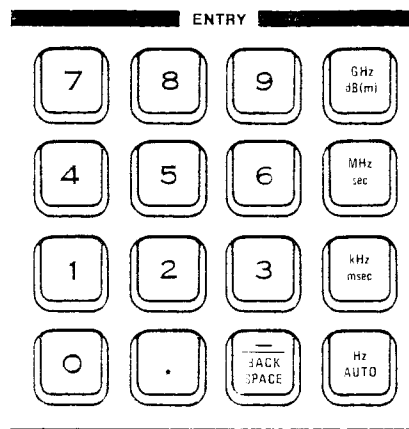

**FUNCTIONS**

[.] [0]...[9] (HP-IB: decimal numbers 0 through 9, - (minus) sign, and decimal point) are the numerical data entry keys. Press any function key, enter the desired numerical value, then press the appropriate terminator key (GHz, sec, dB(m), etc.). Table 1-1 (Specifications) lists the numerical limits for each function.

[SHIFT] (data entry key) has no effect on the HP 8341A.

[ - / BACK SPACE] is a minus sign ( - ) entry when this key is pressed at the beginning of a data entry sequence, a back space at all other times.

[SHIFT] [ - / BACK SPACE] has no effect on the HP 8341A.

[GHz / dB(m)] [MHz / sec] [kHz / msec] [Hz / AUTO] are the terminator keys that must be pressed after a numerical value has been entered. The HP 8341A interprets the terminator key to match the selected function. For example, GHz is selected when a frequency function is active, dB(m) is selected when a power function is active. An explanation of each key follows.

[GHz / dB(m)] (HP-IB: GZ, or DB) selects either gigahertz for a frequency function, decibels or dBm for a power function.

[MHz / sec] (HP-IB: MZ, or SC) selects either megahertz for a frequency function, or seconds for a sweep time function.

[kHz / msec] (HP-IB: KZ, or MS) selects either kilohertz for a frequency function, or milliseconds for a sweep time function.

**[Hz / AUTO]** (HP-IB: HZ. or AU) selects hertz for a frequency function; **AUTO** affects **[SWEEP TIME]**, **FREQ STEP**, and **CW RES**; Press **[SWEEP TIME]** then **[AUTO]** to obtain the shortest possible sweep time for that frequency span; press **[SHIFT] [CF]** then **[AUTO]** to couple the **FREQ STEP** increment size to the  $\Delta F$  frequency span; press **[SHIFT] [CW]** then **[AUTO]** to couple the **CW RES** to the  $\Delta F$  frequency span (all of these shifted functions are explained in Figure 3-7). When one of the **AUTO**-coupled functions is active, "AUTO" or its complement "FIXD" (which indicates that **AUTO** is not active) appears in the **ENTRY DISPLAY**.

**[SHIFT] (terminator key)** allows direct electrical access to the internal circuits, registers, and buffers of the HP 8341A. These tremendously powerful functions are comprehensively explained in Section VIII (Service); however, a brief explanation follows.

**[SHIFT] [GHz / dB(m)]** (HP-IB: SHGZ) allows the I/O channel to be specified. The I/O channel, along with the I/O subchannel (explained in the following paragraph) defines the address for a circuit board or memory register that is accessible via the internal I/O bus. The channel values range from 0 to 15. Channel and subchannel addresses are listed in Section VIII. Press **[SHIFT] [GHz / dB(m)]**, then enter a numerical value between 0-15, followed by any terminator key.

**[SHIFT] [MHz / sec]** (HP-IB: SHMZ) allows the I/O subchannel to be specified. Press **[SHIFT] [MHz / sec]**, then enter a numerical value followed by any terminator key.

**[SHIFT] [kHz / msec]** (HP-IB: SHKZ) allows a numerical value to be written to the address defined by the channel and subchannel. The appropriate numerical value is explained in the relevant parts of Section VIII. Press **[SHIFT] [kHz / msec]**, enter a numerical value, followed by any terminator key.

**[SHIFT] [Hz / AUTO]** (HP-IB: SHHZ) allows a numerical value to be read from the address defined by the channel and subchannel. Press **[SHIFT] [Hz / AUTO]**, and the numerical data will appear in the **ENTRY DISPLAY**. The relevant parts of Section VIII describe the interpretation of this data.

Figure 3-10. Entry (2 of 2)

## DESCRIPTION

Continuous, single, or manual sweeps and internal, external or power line triggering are controlled by these keys. Additionally, display blanking, penlift, and three diagnostic functions are enabled by adding the SHIFT prefix to these keys.

## PANEL LAYOUT

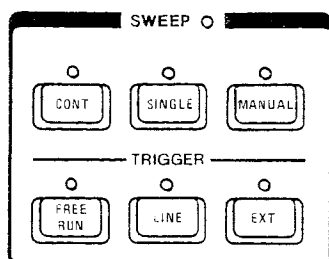

## FUNCTIONS

**[CONT]** (HP-IB: S1) allows continuous sweep-retrace-sweep-retrace cycling of the HP 8341A. The sweep is initiated by one of the TRIGGER functions, as explained later in this Figure, while the sweep speed is controlled by the **[SWEEP TIME]** function as explained in Figure 3-7.

**[SHIFT] [CONT]** (HP-IB: SHS11 disables displays, SHS10 re-enables displays) blanks (turns off) all displays on the HP 8341A. Although the displays are blanked, the functions that are normally shown in the displays can still be changed in the usual manner, and the changed values will be shown when the displays are reactivated. The displays are reactivated in one of two ways: Press **[SHIFT] [CONT]** again to restore the displays, or press **[SHIFT] [M5]** which always restores the displays and cancels any diagnostic routines that are in effect.

**[SINGLE]** (HP-IB: S2) allows single sweeps of the HP 8341A. Press **[SINGLE]** to start the sweep, which will sweep at a rate determined by the **[SWEEP TIME]** function (explained in Figure 3-7). If **[SINGLE]** is pressed in the middle of a single sweep, the sweep will abruptly stop and the HP 8341A will retrace back to the starting point.

**[SHIFT] [SINGLE]** has no effect on the HP 8341A.

**[MANUAL]** (HP-IB: S3) allows manual sweeps. Press **[MANUAL]**, then use the rotary **[KNOB]** to manually sweep between the start/stop limits. In manual mode the HP 8341A will not automatically retrace at the sweep end point (the operator must retrace), and the green LED by the SWEEP label will not light. The resolution of the **[KNOB]** is 0.1% of the sweep span in either start/stop or CF/ $\Delta F$  mode. Frequencies in manual sweep are synthesized, just as they are in CW mode.

There are two significant differences between **[MANUAL]** sweep and the sweep that can be obtained by having the **[KNOB]** control an active CW function:

1. The sweep output voltage ramp (see Figures 3-13 or 3-18, SWEEP OUTPUT) is 0-10 volts in both modes, but in CW mode 0 volts always corresponds to 10 MHz and 10 volts always corresponds to 20 GHz, while in manual sweep mode 0 volts corresponds to the start frequency and 10 volts corresponds to the stop frequency. In both cases the sweep voltage at intermediate frequencies is a linear interpolation of the frequency span (i.e., a frequency half-way between the start/stop limits has a corresponding sweep voltage of 5 volts).

2. The bandcrossing points in CW mode always occur at precisely 2.4, 7.0, and 13.5 GHz. In manual sweep mode the bandcrossing points have 200 MHz of flexibility, which is automatically used by the HP 8341A for optimum performance (for example, a 2.35 to 7.05 sweep could be accomplished without any band changes in manual sweep mode).

**[SHIFT] [MANUAL]** (HP-IB: SHS3) activates the FAULT diagnostic routine. When the amber FAULT annunciator appears in the ENTRY DISPLAY, press **[SHIFT] [MANUAL]** to initiate the FAULT diagnostic which will cause "FAULT: CAL KICK ADC PEAK TRK" to appear in the ENTRY DISPLAY. The flashing cursor indicates which circuit (**CAL**ibration constants, **KICK** pulses, **A**nalog to **D**igital **C**onverter, power **PEAK**ing, or **TRAC**king) is causing the problem. Once the faulty circuit has been identified, consult Section VIII (Service) for instructions on how to remedy the problem.

**[FREE RUN]** (HP-IB: T1) allows internal triggering of the any sweep function, and is the fastest possible way to accomplish the sweep-retrace cycle.

**[SHIFT] [FREE RUN]** (HP-IB: SHT1) activates the display self-test diagnostic function. Press **[SHIFT] [FREE RUN]**, which will cause every segment of every LED in the displays to light, followed by a marching pattern of every character in the display lexicon. Press **[SHIFT] [M5]** to cancel this diagnostic routine and to restore the displays to their previous condition. If this marching display ever appears spontaneously, especially at power-on, the main processor circuit has failed and Section VIII (Service) should be consulted for further instructions.

**[LINE]** (HP-IB: T2) triggers the sweep functions in synchronization with the ac power line frequency, which is typically 50 or 60 Hz.

**[SHIFT] [LINE]** (HP-IB: SHT21 enables penlift, SHT20 disables penlift) generates a penlift signal at each band crossing. When an HP 8341A sweep crosses frequency bands, the RF is momentarily turned off at each band crossing which can cause a negative spike on X-Y recorders. To prevent the negative spike, **[SHIFT] [LINE]** activates a rear-panel PENLIFT OUTPUT connector that causes the X-Y recorder's pen to lift at each band crossing. The PENLIFT function works only when the sweep time is >5 seconds. See Figure 3-18 for information on the rear-panel connector, and the X-Y Recorder Operating Guide (at the end of Section III) for specific information on X-Y recorder interconnections.

**[EXT]** (HP-IB: T3) externally triggers the sweep function. Figure 3-18 explains the rear-panel EXT TRIGGER INPUT connector and the trigger signal requirements.

**[SHIFT] [EXT]** (HP-IB: SHT3) activates the oscillator diagnostic function. When the red UNLK annunciator appears in the ENTRY DISPLAY, press **[SHIFT] [EXT]**, which will cause "OSC: REF M/N HET YO N2 N1" to appear in the ENTRY DISPLAY. The flashing cursor indicates which oscillator circuit is not phase locked, with the remedy found in the appropriate part of Section VIII (Service). Press **[SHIFT] [M5]** to cancel this diagnostic function and to return the displays to their previous condition.

## INDICATORS

**SWEEP** green LED lights when the HP 8341A is performing an analog sweep. The LED is off during all of the following: retrace, band crossings (band crossings occur at 2.3 GHz, 7.0 GHz, and 13.5), during the phase locking that occurs at the start frequency of each new sweep and each new band, and during manual sweeps (since manual sweeps are synthesized).

## DESCRIPTION

Instrument check and preset, HP-IB address assignment, storage and recall of operating configurations, alternating operation, and restoration of local control are the functions of this key group.

## PANEL LAYOUT

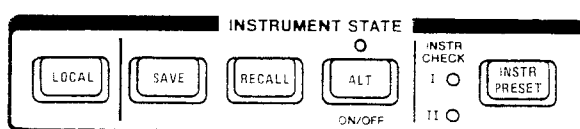

## FUNCTIONS

**[LOCAL]** (HP-IB: LOCAL command). The front panel keys (except **[LOCAL]** and the POWER switch) are inoperative when the HP 8341A is being remotely controlled by a computer. Press **[LOCAL]** to cancel computer control and to reactivate the front panel keys. **[LOCAL]** does not work if the computer executed a LOCAL LOCKOUT command, as explained in the HP-IB section of this chapter.

**[SHIFT] [LOCAL]** (no HP-IB code) causes the HP-IB address to appear in the ENTRY DISPLAY. The factory-set address is 19; however, any unique address between 00-30 can be assigned to the HP 8341A by pressing **[SHIFT] [LOCAL]**, entering the address numbers, and pressing any terminator key (GHz, MHz, kHz, Hz). This new address remains in effect until again changed by the operator. The calibration constants (described in Section VIII) can be configured to disable the **[SHIFT] [LOCAL]** function, thus locking the HP 8341A to the address specified in the calibration constants.

**[SAVE]** (HP-IB: SVn, n=1-9) allows up to 9 different front panel settings to be stored in memory registers 1 through 9. Instrument settings can then be recalled via the **[RECALL] n** (n = 0 through 9, where 0 is the last-used front panel setting) function, or a memory setting can be alternated with the current front panel setting with the **[ALT] n** (n = 1 - 9) function. Set the front panel controls to any desired configuration, then press **[SAVE]** which will cause "SAVE REGISTER: ?" to appear in the ENTRY DISPLAY. Press any digit 1-9 to select the storage register, and the setting will be saved in that register. The information stored in the memory registers is retained in memory indefinitely when ac line power is constantly available, or for approximately one year without line power.

**[SHIFT] [SAVE]** (HP-IB: SHSV) is a save-lock that prevents any new front panel settings from being saved. **[SHIFT] [RECALL]** removes the save lock.

**[RECALL]** (HP-IB: RCn, n=0-9) retrieves a front panel setting that was previously SAVED in storage registers 1-9 ( **[RECALL] [0]** retrieves the last-entered front panel setting). Press **[RECALL]**, which will cause "RECALL REGISTER: ?" to appear in the ENTRY DISPLAY. Then press any digit 0-9, or use the **[STEP]** keys, to select the desired memory register. (The rear panel "8410 CONNECTOR" has a pin that duplicates the step-recall function, as explained in Figure 3-21 and the HP 8341A/HP 8410 Operating Guide)

**[SHIFT] [RECALL]** (HP-IB: SHRC) cancels the save-lock function, which is described in the previous **[SHIFT] [SAVE]** paragraph.



[**ALT**] (HP-IB: ALIn, n=1-9 turns on the function, AL0 turns off the function) causes the instrument state to alternate on successive sweeps between the current front panel setting and the setting stored in memory location 1-9. Press [**ALT**], which will cause "ALT WITH REGISTER: ?" (? is the last used memory register) to appear in the ENTRY DISPLAY, then press a digit 1-9 to select the desired memory register. Although the HP 8341A is in the alternate mode, the panel displays will only show the current front panel state. The power level of the two alternated functions must have the same attenuator setting, or the attenuator must be decoupled from the ALC (automatic leveling control circuit) which will allow up to 40 dB of power level difference. This restriction is necessary to prevent rapid cycling, and subsequent wear, on the mechanical attenuator. See [**PWR SWP**] in Figure 3-17 for an explanation of the attenuator and ALC relationship. Press [**ALT**] again to cancel the alternate function.

[**SHIFT**] [**ALT**] has no effect on the HP 8341A.

[**INSTR PRESET**] (HP-IB: IP) causes an internal self-test of the HP 8341A, and initializes the instrument to a standard starting configuration:

1. Start sweep at 10 MHz, stop sweep at 20 GHz.
2. Power level set to 0.0 dBm; however, this level can be reset by changing the calibration constants (as described in Section VIII).
3. Sweep time to AUTO (44.15 msec).
4. CONT sweep, FREE RUN trigger.
5. All markers set to 9.995 GHz (center frequency of the sweep).
6. The checksum of the calibration data is calculated, and if an error is detected then the calibration data in protected memory is used. If the checksum of the protected data is not correct then default values are used, and the FAULT annunciator lights in the ENTRY DISPLAY to indicate a calibration constant error (press [**SHIFT**] [**MANUAL**] when the FAULT annunciator lights, as described in Figure 3-11).
7. All function values stored in memory registers 1-9 are reset to default values.
8. A self test is performed, and check LEDs are lighted.

Press [**INSTR PRESET**] at any time to test the instrument and restore the standard starting condition. If either of the two red LEDs that are adjacent to [**INSTR PRESET**] (labeled "INSTR CHECK I," "II") remain lighted after a preset, the HP 8341A failed the self-test; refer to Section VIII (Service) for further instructions.

[**SHIFT**] [**INSTR PRESET**]: [**SHIFT**] has no effect on [**INSTR PRESET**].

#### INDICATORS

**INSTR CHECK I / II** red LEDs light if the HP 8341A fails the internal self-test that occurs when [**INSTR PRESET**] is pressed. If this happens, refer to Section VIII (Service) for further instructions.

## DESCRIPTION

The POWER power switch and the SWEEP OUTPUT front-panel BNC connector are described in this Figure.

## PANEL LAYOUT

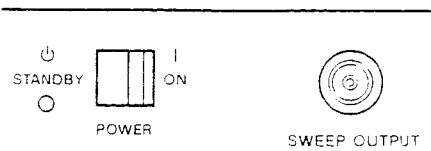

## FUNCTIONS

**POWER SWITCH** selects either ON, or STANDBY. Once the ac power line has been plugged in, power is always being applied to all or part of the HP 8341A: In STANDBY, power is applied to the crystal oscillator's oven to maintain operating temperature and to the RAM circuits to maintain memory data; in the ON position, power is applied to the entire instrument. When the HP 8341A is connected to ac power for the first time, or after a prolonged period without power, the crystal oscillator's oven requires approximately 30 minutes to reach operating temperature (the red OVEN annunciator in the ENTRY DISPLAY will be lighted during this warm-up period). Power must always be available to the HP 8341A to keep the oven warm; therefore, when the instrument is not in use set the POWER switch to STANDBY, and do not interrupt the ac power.

When the POWER switch is changed from STANDBY to ON, the HP 8341A will automatically initiate an internal circuit check, then momentarily show the HP-IB address in the ENTRY DISPLAY, followed by setting the instrument functions to the last-entered values. If this sequence does not happen, press [INSTR PRESET] to initiate an instrument check, as described in Figure 3-12. If a warning annunciator lights at power-on, refer to the display Figures 3-3, 3-4, 3-5, and 3-6 for further instructions.

**SWEEP OUTPUT** is provided by a front panel BNC connector (and an identical rear panel BNC connector). The output voltage range for this connector is 0 to +10 volts dc. When the HP 8341A is sweeping, the SWEEP OUTPUT is 0 Vdc at the beginning of the sweep and +10 Vdc at the end of the sweep, regardless of sweep width. In CW mode, the SWEEP OUTPUT ranges from 0 Vdc at the 10 MHz minimum frequency of the HP 8341A, to 10 Vdc at the 20 GHz maximum frequency, with a proportional voltage for frequencies between 10 MHz - 20 GHz. Pressing [CW] then [MANUAL] locks the CW frequency but allows a full-range voltage output from the SWEEP OUTPUT, which is controlled by the rotary [KNOB] (useful, for example, when scaling an X-Y recorder). The output impedance at this SWEEP OUTPUT connector is nominally 1 k $\Omega$ .

## DESCRIPTION

These two keys select pulse and/or amplitude modulation of the RF output, and are used in conjunction with the front panel **PULSE** and **AM** BNC connectors (described in Figure 3-15). Table 1-1 (Specifications) lists all electrical parameters of these two modulation functions.

## PANEL LAYOUT

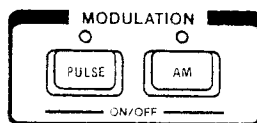

**[PULSE]** (HP-IB: PM1) turns on pulse modulation (Option 006), PM0 turns off the function) activates the pulse modulation function. When pulse modulation is in effect, the RF output of the HP 8341A is turned on (full power selected) and off (>80 dB attenuation) at a rate determined by the pulse modulation input (described in Figure 3-15). Pulse and amplitude modulation can be in effect simultaneously (amplitude modulation is described in a following paragraph). Press **[PULSE]** a second time to turn off the function.

**[SHIFT] [PULSE]** has no effect on the HP 8341A.

**[AM]** (HP-IB: AM1) turns on amplitude modulation, AM0 turns off the function) activates the amplitude modulation function. Amplitude modulation allows the pre-attenuated RF output of the HP 8341A to be continuously and linearly varied between -30 dBm and the maximum power available, at a rate determined by the **AM** input (described in Figure 3-15). Amplitude and pulse modulation can be in effect simultaneously. Press **[AM]** a second time to turn off the function.

**[SHIFT] [AM]** (HP-IB: SHAM) activates the AM function and increases the ALC (automatic leveling control) bandwidth in the pulse modulation mode to reduce the settling time of the pulses. Settling time is the typical amount of time needed for the amplitude of the internally leveled RF pulse to come to within 10% of its final value after a change in the pulse amplitude has been initiated. Settling time values are listed in Table 1-1. The cost for the faster settling time obtained by **[SHIFT] [AM]** is a slight degradation of the pulse envelope, and a change of the minimum pulse repetition frequency from 100 Hz to 1 kHz.

## DESCRIPTION

The external pulse or amplitude modulation signals are applied to the HP 8341A at these two BNC connectors.

## PANEL LAYOUT

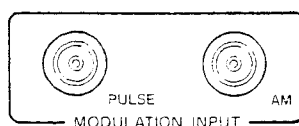

## FUNCTIONS

**PULSE MODULATION INPUT** (Option 006) is TTL compatible: a TTL high input ( $> +2$  volts) causes maximum selected RF power output, while a TTL low input causes minimum RF output ( $> 80$  dB RF on/off ratio). The pulse repetition frequency is dc to 20 MHz in non-leveled applications, 100 Hz to 5 MHz when internally leveled, or 1 kHz to 5 MHz when internally leveled in the extended bandwidth mode ([**SHIFT**] [**AM**]). Table 1-1 (Specifications) details the electrical requirements of the **PULSE** modulation input, and explains the subsequent effects on the RF output. The damage levels for this input are  $\cong +12$  volts or  $\cong -20$  volts.

**AM MODULATION INPUT** accepts a  $-1$  volt to  $+1$  volt signal, at a frequency of dc to 100 kHz (3 dB bandwidth). With an **AM** input of 0 volts, the RF output level (the reference level) is unaffected; at  $-1$  volts input the RF is shut off, and at  $+1$  volts input the RF output is 100% (6 dB) higher than the reference level (hence there must be  $\cong 6$  dB of headroom between the reference power level and the maximum power level available at that frequency). The on (0 volt input) to off ( $-1$  volt input) ratio is a function of power level and frequency, but is always greater than 20 dB. The amplitude of the RF output changes linearly as the **AM** input changes from  $-1$  to  $+1$  volts. Table 1-1 (Specifications) lists all electrical requirements of the **AM** input, and explains the subsequent effects on the RF output. Damage level for this input is  $\cong +12$  volts or  $\cong -12$  volts.

Figure 3-15. Modulation Input

## DESCRIPTION

Internal or external (crystal or power meter) power leveling is selected by these keys, which also select a band crossing diagnostic and allow direct linear modulator access. The external leveling BNC input connector is also described in this Figure.

## PANEL LAYOUT

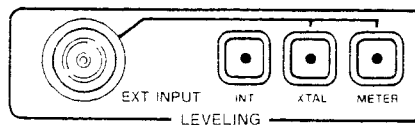

## FUNCTIONS

**EXT INPUT** BNC connector is the input port for an external leveling signal. The signal requirements are listed in Table 1-1. See the Operating Guide "Externally Leveling the HP 8341A Synthesized Sweeper," located at the end of Section III, for detailed information about external leveling procedures.

**[INT]** (HP-IB: A1) selects internal leveling of the HP 8341A. Table 1-1 (Specifications) lists the maximum leveled power for each frequency band, and other power function restraints.

**[SHIFT] [INT]** (HP-IB: SHA1) allows single-stepping through each frequency band, and is used with **[SHIFT] [XTAL]** for a band crossing diagnostic routine. See **[SHIFT] [XTAL]** for an explanation of how these two shifted functions interact, and see Section VIII (Service) for a comprehensive explanation of this diagnostic function.

**[XTAL]** (HP-IB: A2) activates external crystal leveling of the HP 8341A. A portion of the RF output (derived from a coupler or a splitter) must be detected, with the detected output being delivered to the **EXT INPUT** BNC connector, thus forming an output-input feedback loop (the loop typically has 7 kHz bandwidth). Press **[XTAL]**, and "ATN: -xx dB, REF: -xx.xx dBV" (where x is the last-entered value) will appear in the entry display. Then use the rotary **[KNOB]** or the numerical keys with the **[dB(m)]** terminator key to change the REFERENCE level, and the **[STEP]** keys to change the ATN (Options 001, 004) while watching either the POWER dBm display (allowing for losses in the coupler or splitter) or an attached power meter. The "Externally Leveling the HP 8341A Synthesized Sweeper" operating guide (HP Part Number 08340-90041) located at the end of this Section fully explains crystal leveling and shows typical equipment interconnections.

**[SHIFT] [XTAL]** (HP-IB: SHA2) activates a band crossing diagnostic function. Press **[SHIFT] [XTAL]** to enable the diagnostic, then press **[SHIFT] [INT]**, which will cause the HP 8341A to sweep to the first band crossing point and stop at that point. Press **[SHIFT] [INT]** again and the HP 8341A will sweep to the next band crossing point and stop at that point. Continue pressing **[SHIFT] [INT]** to single-step through each of the bands. Press **[SHIFT] [XTAL]** again to cancel this diagnostic routine. **[SHIFT] [XTAL]** used without **[SHIFT] [INT]** will cause the HP 8341A to stop at the end of a sweep.

**[METER]** (HP-IB: A3) selects external power meter leveling of the HP 8341A. A portion of the RF output must be measured by a power meter, with the power meter also connected to the **EXT INPUT** BNC connector to form an output-input feedback loop (typical bandwidth 0.7 Hz). Press **[METER]**, which will cause (after a brief delay) "ATN: -xx dB, REF: -xx.xx dBV" (where x is the last-entered value) to appear in the ENTRY DISPLAY. Use the rotary **[KNOB]** or the numerical keys with the **[dB(m)]** terminator key to set the REFERENCE level, and the **[STEP]** keys to set the ATN (Options 001, 004) while watching either the POWER dBm display (allowing for coupler or splitter losses) or the power meter. An operating guide, "Externally Leveling the HP 8341A Synthesized Sweeper" (HP Part Number 08340-90041), located at the end of this Section fully explains power meter leveling.

**[SHIFT] [METER]** (HP-IB: SHA3) bypasses the ALC (automatic leveling control) to allow direct control of the linear modulator circuit, which is useful when very narrow pulses are being generated in pulse modulation mode. In this mode there is no limit on the minimum pulse repetition frequency. Press **[SHIFT] [METER]**, which will cause "ATN: -xx dB, MOD: x.x dB" (where x is the last-entered value) to appear in the ENTRY DISPLAY. To set the power, place the HP 8341A in CW mode (Option 006), or in pulse modulation mode with pulses wider than 2  $\mu$ sec. Then use the **[STEP]** keys to set the ATN (attenuator) (Options 001, 004), and the rotary **[KNOB]** or numerical keys with **[dB(m)]** terminator key to set the MOD (linear modulator), as follows: Set MOD entry at 0 dB, increment ATN until the POWER dBm display shows a level 5 dB to 15 dB higher than the desired output power, then reduce the power to the desired level by changing the MOD value. The POWER dBm display shows actual power when the HP 8341A is in CW or wide-pulse pulse modulation modes: this actual power changes very little as the pulse width is narrowed, even though the POWER dBm reading drops. Therefore, at this point reduce the pulse width to the desired value and ignore the POWER dBm display. The ATN and MOD values in the ENTRY DISPLAY also have a limitation: Although the ATN displayed value is always accurate, the MOD becomes saturated in the top 10 dB (approximately) of its range at which point no change occurs in the true power: furthermore, the modulation entry is only approximately calibrated. Consequently, rely on the POWER dBm display for the true power level instead of the MOD value. See Figures 3-14 and 3-15 for additional pulse modulation information. **[SHIFT] [METER]** can also be used as a diagnostic function for the ALC circuits, as described in Section VIII (Service).

Figure 3-16. Leveling (2 of 2)

## DESCRIPTION

All RF power functions, except for power level, are controlled by these keys; and the RF output port is contained in this group.

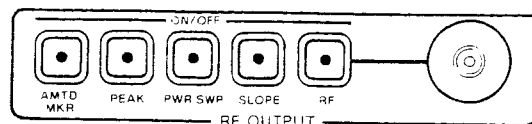

## FUNCTIONS

**[AMTD MKR]** (HP-IB: AK1 turns on amplitude markers, AK0 turns off amplitude markers) changes intensity-dot markers to amplitude-spike markers on a CRT display. When the markers are activated after an **[INSTR PRESET]**, markers **[M1]** . . . **[M5]** appear as intensified dots on a CRT display; press **[AMTD MKR]** to change all of the markers to amplitude spikes. Press **[AMTD MKR]** again to return to intensified-dot markers.

**[SHIFT] [AMTD MKR]** (HP-IB: SHAK) causes an instantaneous execution of the peaking function, when the HP 8341A is in CW or manual mode. This is a one-time implementation of peaking, where the function is quickly turned on then turned off. Peaking is explained in the next paragraph.

**[PEAK]** (HP-IB: RP1 turns on peaking, RP0 turns off peaking) aligns the output filter (SYTM) so that its passband is centered on the RF output, in CW or manual-sweep mode. Peaking is used to obtain the maximum available power and spectral purity, and best pulse envelopes, at a given frequency. Press **[PEAK]**, and the HP 8341A will automatically peak the present CW frequency, and continue to peak new frequencies as they are entered by the **[KNOB]**, or the **[STEP]** keys, or the numerical keys (with a terminator key). If **[PEAK]** is on for an extended time, the peaking function will automatically re-peak every 7 minutes. Press **[PEAK]** again to cancel this function. When **[PEAK]** is activated, the HP 8341A performs a coarse alignment, and then a fine alignment that begins at the final setting of the coarse search; **[SHIFT] [AMTD MKR]** initiates only a fine alignment which begins at the present instrument setting. **[SHIFT] [AMTD MKR]** is faster, but has less adjustment range than **[PEAK]**. **[SHIFT] [PEAK]**, described in the next paragraph, is a related function.

**[SHIFT] [PEAK]** (HP-IB: SHRP) is a more extensive version of peaking, **[PEAK]**, which requires a fraction of a second to implement, aligns the output filter with a single CW frequency, while **[SHIFT] [PEAK]** aligns all of the YTM tracking calibration constants and requires 5-10 seconds to implement. Use **[SHIFT] [PEAK]** to enhance the power output and spectral purity of swept modes, and to improve tracking performance (especially in harsh environments having wide temperature variations). Press **[SHIFT] [PEAK]**, which will cause "AUTO TRACKING" to appear in the ENTRY DISPLAY. "AUTO TRACKING" will disappear after 5-10 seconds when the calibration has been completed.

**[PWR SWEEP]** (HP-IB: PS1 turns on power sweep, PS0 turns off the function) allows the power output to be swept when the HP 8341A is in CW mode. This is the procedure:

1. Select a CW frequency, as explained in Figure 3-7.
2. Press **[SHIFT] [PWR SWEEP]**, which decouples the attenuator (ATN) from the automatic leveling control (ALC) and displays the ATN (Options 001, 004) and ALC values in the ENTRY DISPLAY. The ALC range is  $-20$  dBm to an upper value that depends on frequency (see Table 1-1 for the specifications).

3. Use the **[STEP]** keys to set the value of the ATN (Options 001, 004), and the **[KNOB]** or numerical keys with **[dB(m)]** terminator key to set the ALC for the starting power level, as shown in the POWER dBm display. The ALC value should be as close as possible to -20 dBm to achieve the widest-span power sweep.
4. Set the **[SWEEP TIME]**, as explained in Figure 3-7.
5. Press **[PWR SWEEP]**, which will cause "POWER SWEEP: x.xx dB/SWP" (where x is the last-entered value) to appear in the ENTRY DISPLAY. Use either the **[KNOB]**, the **[STEP]** keys, or the numerical keys with the **[dB(m)]** terminator key to select the span of the power sweep (positive values only, ranging from 0.0 to 40.00 dB/SWP).
6. Select SWEEP and TRIGGER, as described in Figure 3-11.

If only narrow-span power sweeps are necessary, the ATN (Options 001, 004) does not need to be decoupled from the ALC: Omit steps 2 and 3 in the preceding text, using instead the **[POWER LEVEL]** key to set the initial power output. This simplified procedure restricts the range of power sweeps to that of the coupled ALC, which is -9.95 dBm to the maximum power permitted (maximum power depends on frequency, as listed in Table 1-1).

**[SHIFT] [PWR SWEEP]** (HP-IB: SHPS) decouples the attenuator (ATN) (Options 001, 004) from the automatic leveling control (ALC), as explained in the preceding function. Recouple the ATN and ALC by pressing **[POWER LEVEL]**.

**[SLOPE]** (HP-IB: SL1 turns on the slope function, SL0 turns off the function) compensates for system or cable losses at high frequencies by linearly increasing the power output as the frequency increases. Press **[SLOPE]**, which will cause "RF SLOPE: xx.xx dB/GHz" (where x is the last-entered value) to appear in the ENTRY DISPLAY. Use either the **[KNOB]**, the **[STEP]** keys, or the numerical keys with the **[dB(m)]** terminator key to set any positive slope value between 0.000 to 1.500 dB/GHz. Press **[SLOPE]** again to cancel this function.

**[SHIFT] [SLOPE]** (HP-IB: SHSL) allows front panel control of the mechanical attenuator (ATN) (Options 001, 004). Press **[SHIFT] [SLOPE]**, which will cause "ATN: x dB" (where x is the last-entered value) to appear in the ENTRY DISPLAY. Use the **[STEP]** keys, or the numerical keys with any terminator key to change the attenuator value within the range 0 dB to -90 dB in 10 dB steps. Keyboard entries are automatically rounded to the nearest 10 dB. The clicking sound heard after each attenuator change is the attenuator pad being mechanically switched into the RF output path.

**[RF]** (HP-IB: RF1) turns on RF output. RF0 turns off RF output) turns the RF output on or off. Press **[RF]**, which will cause "- OFF -" to appear in the POWER dBm display and will cause the output power to be turned off (output << -110 dBm). Press **[RF]** again to turn on the RF output, restoring the last-entered power output.

**[SHIFT] [RF]** has no effect on the HP 8341A.

**RF OUTPUT CONNECTOR** consists of a precision Type-N female connector. The output impedance, SWR, and other electrical characteristics are listed in Table 1-1 (Specifications). When making connections, carefully align the center conductor elements, then rotate the knurled collar of the Type-N male connector being connected while holding the connecting component still, until a firm contact is obtained.



## DESCRIPTION

The electrical characteristics and requirements of the rear panel BNC connectors are listed in this Figure.

## PANEL LAYOUT

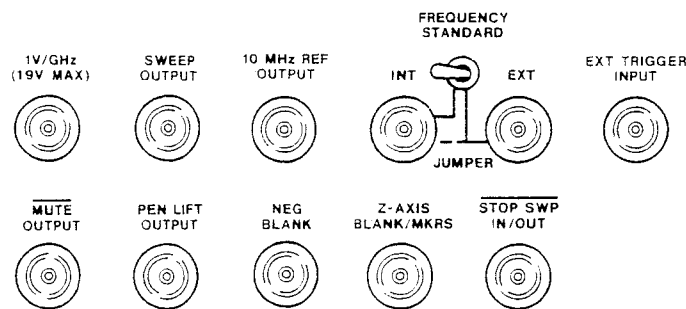

## FUNCTIONS

**1 V/GHz** outputs a voltage that is proportional to the RF output frequency, with a ratio of 1 volt output per 1 GHz RF frequency. The maximum output voltage is 19 V; hence, this BNC output is not proportional above 19 GHz. Load impedance should be  $\geq 4 \text{ k}\Omega$ . Accuracy is  $1 \text{ V/GHz} \pm 1\% \pm 2 \text{ mV}$ . An output voltage ratio of 0.5 volts/GHz can be achieved by clipping two jumpers on the A28 SYTM board (see Section VIII), which would allow a proportional output for the entire 10 MHz to 20 GHz frequency span of the HP 8341A.

**SWEEP OUTPUT** is provided by a rear panel BNC connector, and an identical front panel BNC connector. The output voltage range for this connector is 0 to +10 volts dc. When the HP 8341A is sweeping, the **SWEEP OUTPUT** is 0 Vdc at the beginning of the sweep and +10 Vdc at the end of the sweep regardless of sweep width. In CW mode, the **SWEEP OUTPUT** ranges from 0 Vdc at the 10 MHz minimum frequency of the HP 8341A, to 10 Vdc at the 20 GHz maximum frequency, with a proportional voltage for frequencies between 10 MHz - 20 GHz. Pressing [CW] then [MANUAL] locks the CW frequency but allows a full-range voltage output from the SWEEP OUTPUT, controlled by the rotary [KNOB] (useful, for example, when scaling an X-Y recorder). The output impedance at this **SWEEP OUTPUT** connector is nominally  $1 \text{ k}\Omega$ . Figure 3-13 also describes SWEEP OUTPUT.

**10 MHz REF OUTPUT** provides a 0 dBm, 10 MHz signal derived from the internal frequency standard of the HP 8341A. Test instruments are connected to this  $50 \text{ }\Omega$  BNC connector while the 10 MHz crystal oscillator is being adjusted (as described in Section VIII, Service, of this Manual), or this can be the master clock reference output for a network of instruments.

**INT / EXT SWITCH & BNC CONNECTORS** select either the internal (INT) 10 MHz crystal oscillator frequency standard, or an external (EXT) frequency standard to be used as the master timebase for the HP 8341A. To select the internal standard, place the switch in the **INT** position and connect a jumper cable between the **INT** and **EXT** BNC connectors (the **INT** BNC is now outputting 10 MHz at +3 dBm). To use an external standard, disconnect the jumper, change the switch to **EXT**, and connect the external source to the **EXT** BNC connector. The external source must be either 5 MHz  $\pm$  50 Hz, or 10 MHz  $\pm$  100 Hz, and provide 0 to +10 dBm into the 50  $\Omega$  BNC connector. When the switch is in the **EXT** position the amber **EXT REF** annunciator lights in the ENTRY DISPLAY.

**EXT TRIGGER INPUT** triggers the start of a sweep. Trigger signal must be >2 volts (10 V maximum), and wider than 0.5  $\mu$ sec. Nominal input impedance is 2 k $\Omega$ . Figure 3-11 describes the front panel procedures that are involved in sweep operations.

**MUTE OUTPUT** causes the servo motor of an X-Y recorder to pause while the HP 8341A crosses a frequency band switchpoint. The X-Y recorder Operating Guide, located at the end of Section III, explains the interaction of recorders with the HP 8341A.

### PENLIFT OUTPUT J13

#### OPERATION WITH X-Y RECORDERS

PENLIFT disables an X-Y recorder's ability to lower its pen during sweep retrace. If [**SHIFT**] [**LINE**] is pressed on the Front Panel, PENLIFT will also disable the pen during forward sweep band switchpoints. Because of X-Y recorder limitations PENLIFT will always disable the X-Y recorder's pen at sweep times under 5 seconds.

PENLIFT enables pen operation by providing a current path to ground for the X-Y recorder's pen solenoid. The voltage at the PENLIFT output in this state will be approximately 0 Vdc. Circuit impedance in this state is approximately 0.5 Ohms (Q3 on).

PENLIFT disables pen operation by not providing a current path to ground for the X-Y recorder's pen solenoid. The voltage on the PENLIFT output will be equal to the X-Y recorder's pen solenoid supply voltage. Circuit impedance in this state is very high (Q3 open). A 56.2 volt zener diode protects the PENLIFT circuit from excessively high X-Y recorder solenoid voltages. A57CR10 protects the circuit from negative voltages on the input.

#### OPERATION WITH TTL LOADS

The PENLIFT output will be at TTL levels if connected to TTL devices.

**NEG BLANKING** provides a negative rectangular pulse (approximately -5 volts into 2 k $\Omega$ ) during retrace and band switchpoints when the HP 8341A is sweeping.

**Z-AXIS BLANK/MKRS** supplies a positive rectangular pulse (approximately +5 volts into 2 k $\Omega$ ) during the retrace and band switchpoints when the HP 8341A is sweeping. This output also supplies a -5 volt pulse when the RF output is coincident with a marker frequency (intensity markers only, as explained in Figure 3-9).

**STOP SWP IN/OUT** abruptly stops a sweep when this input is grounded. Retrace does not occur, and the sweep will resume when this input is ungrounded.

**DESCRIPTION**

The two rear panel RF Output connectors (one standard, one an option) are described in this Figure.

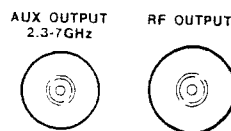
**PANEL LAYOUT****FUNCTIONS**

**AUX OUTPUT 2.3 - 7 GHz** is a type N female connector that provides a 0 dBm Output from the HP 8341A's fundamental YIG oscillator (the higher frequencies obtainable from the HP 8341A are multiples of this oscillator). Impedance of this connector is 50  $\Omega$  (nominal).

**RF OUTPUT** is an optional rear panel RF output connector that is functionally equivalent to the standard front panel RF output connector (which is described in Figure 3-17). Option 004 is a rear panel RF output with attenuator, and Option 005 is a rear panel RF output without attenuator. The specifications for each option are listed in Table 1-1 (Section I of this Manual). Contact the nearest HP Sales and Service Office for information about retrofitting an HP 8341A with one of these options.

*Figure 3-19. Rear Panel RF Output*

**DESCRIPTION**

The procedures for connecting the HP 8341A to other HP-IB instruments is explained in this Figure.

**PANEL LAYOUT**

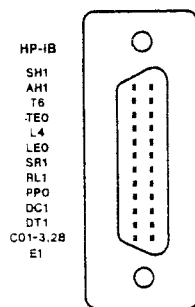

**FUNCTIONS**

The HP-IB interface connector allows the HP 8341A to be connected to any other instrument or device on the HP-IB bus. A complete illustration of pin configuration and signals on the HP-IB interface connector is given in Section II of this Manual.

All HP-IB instruments are interconnected with special HP-IB cables and adapters. These special cables, shown in the accompanying illustration, assure that the proper voltage levels and timing relations are maintained on the HP-IB bus. The adapters are principally extension devices for instruments that have recessed or crowded HP-IB connectors.

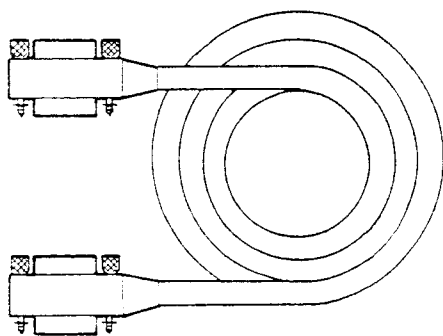

*HP-IB Interface Cables Available*

HP-IB Cable Part Numbers	Lengths
HP 10833A	1 m (3.3 ft.)
HP 10833B	2 m (6.6 ft.)
HP 10833C	4 m (13.2 ft.)
HP 10833D	0.5 m (1.6 ft.)

As many as 14 HP-IB instruments can be connected to the HP 8341A (15 total instruments in the system). The cables can be interconnected in a "star" pattern (one central instrument, with HP-IB cables emanating from that instrument like spokes in a wheel), or in a linear pattern (like boxcars in a train), or in any combination pattern. However, there are certain restrictions:

- Each instrument must have a unique HP-IB address ranging from 0-30 (decimal). Figure 2-12, [SHIFT] [LOCAL] explains HP-IB addressing for the HP 8341A.

- In a two-instrument system that uses just one HP-IB cable, the cable length must not exceed 4 metres (13 feet).
- When more than two instruments are connected on the bus, the cable length to each instrument must not exceed 2 metres (6.5 feet) per unit.
- The total cable length between all units cannot exceed 20 metres (65 feet).

Hewlett-Packard manufactures HP-IB Extender instruments (Models 37201A, 37203A/L) that overcome the range limitations imposed by the cabling rules. These extenders allow twin-pair cable operation up to 1000 metres (3,280 feet), and telephone modem operation over any distance. HP Sales and Service offices can provide additional information on HP-IB extenders.

The codes next to the HP-IB connector describe the HP-IB electrical capabilities of the HP 8341A, using IEEE Std 488-1978 mnemonics (HP-IB, GP-IB, IEEE-488, and IEC-625 are all electrically equivalent). Briefly, the mnemonics translate as follows:

**SH1:** Source Handshake, complete capability.

**AH1:** Acceptor Handshake, complete capability.

**T6:** Talker; capable of basic talker, serial poll, and unaddress if MLA.

**TE0:** Talker, Extended address; no capability.

**L4:** Listener; capable of basic listener, and unaddress if MTA.

**LE0:** Listener, Extended address; no capability.

**SR1:** Service Request, complete capability.

**RL1:** Remote Local, complete capability.

**PP0:** Parallel Poll, no capability.

**DC1:** Device Clear, complete capability.

**DT1:** Device Trigger, complete capability.

**C0, 1, 2, 3, 28:** Controller capability options: C0, no capabilities; C1 system controller; C2, send IFC and take charge; C3, send REN; C28, send I.F. messages.

**E1:** Electrical specification indicating open collector outputs.

These codes are completely explained in the **IEEE Std 488-1978** document, published by The Institute of Electrical and Electronic Engineers, Inc., 345 East 47th Street, New York, New York 10017.

**DESCRIPTION**

This connector interfaces the HP 8341A to the HP 8410B/C Network Analyzer.

**PANEL LAYOUT**

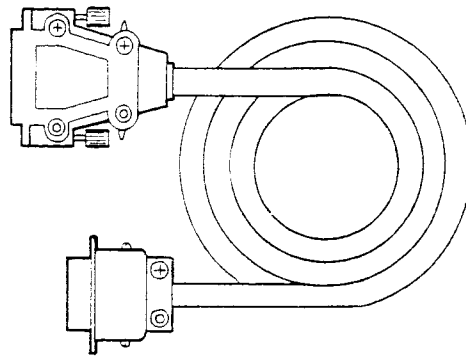
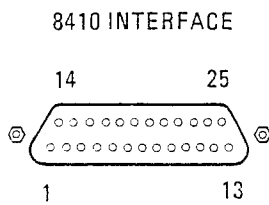

**FUNCTIONS**

Connect the HP 8410B/C Network Analyzer to this port on the HP 8341A, using a Source Control Cable (HP Part Number 08410-60146). An Operating Guide at the end of this Section explains HP 8410B/C to HP 8341A interconnections. Section VIII (Service) describes the electrical requirements for this connector.

This connector has pins that duplicate several rear panel functions, including EXT TRIGGER INPUT, MUTE OUTPUT, PENLIFT OUTPUT, NEG BLANK, and Z-AXIS BLANK/MKRS. There is also a pin input for a switch closure to execute the UP key function, which is used to step through a series of saved instrument states. Additional information is contained in Section VIII, as well as in the HP 8410B/C Operating and Service Manual.

*Pin Description of the 8410 Interface Connector*

Pin No.	Description	Pin No.	Description
1	Not Used	13	Not Used
2 -	Marker Pulse (O)	14 -	Blanking (O)
3 -	Pen Lift Request (I)	15 -	Marker Pulse Request (I)
4 -	Sweep Alternate (O)	16 -	Retrace (O)
5 -	Stop Fwd. Sweep Request (I)	17 -	Alternate Sweep Enable (O)
6	+5 Volt (100 ma MAX) (O)	18 -	Stop Sweep Request (I)
7 -	RF Blanking (O)	19	Digital Ground (I/O)
8 -	RF Blank Request (I)	20 -	Blanking Pulse Request (I)
9 -	External Trigger Input (I)	21 -	Counter Trigger (O)
10 -	Pen Lift (O)	22 -	Step Up Advance (I)
11 -	Recorder Mute (O)	23 -	Inverse Pen Lift (O)
12	Not Used (O)	24 -	8410 External Trigger (O)
13	Not Used	25	Not Used
14 -	Blanking (O)		

- Negative Logic (True is logical "0") (I) Input  
 - Positive Logic (O) Output

*Figure 3-21. HP 8410 Interface (1 of 2)*

8410C INTERFACE CONNECTOR J18						
J18 Pin	Mnemonic	Levels	Input/Output	Signal Source/Destination	A62J31 Pin	J18W46 Wire Color Code
1						
2	Z-AXIS BLANK	+5V, -5V*	OUTPUT	A57P1-99	2, 16	2
3						
4	LALTSEL	TTL (LOW TRUE)	OUTPUT	A57P1-59	10, 24	0
5	LSSP (LSTOP SWEEP)	TTL (LOW TRUE)	I/O	A57P1-107	5, 19	5
6	+5.2V			A52P1-17, 18, 41, 42	3	3
7						
8						
9	<u>MUTE</u>	TTL (LOW TRUE)	INPUT	A57P1-61	8, 22	4
10	EXT TRIG	EXT SOURCE INPUT LEVEL	INPUT	A57P1-106	4, 18	6
11	PEN LIFT	SEE TEXT	OUTPUT	A57P1-108	6, 20	8
12						
13						
14	NEG BLANK	0V, -5V*	OUTPUT	A57P1-41	1, 15	1
15						
16	LRETRACE	TTL (LOW TRUE)	OUTPUT	A57P1-58	11, 25	9 - 0
17	LALTEN	TTL (LOW TRUE)	OUTPUT	A57P1-60	9, 23	9
18						
19	GND			STOP SWEEP BNC GND LUG		9 - 0 - 7
20						
21						
22	LSTEPUP	TTL (LOW TRUE)	INPUT	A62J1-28	14	9 - 0 - 8
23						
24	8410 TRIG	TTL (LOW TRUE)	OUTPUT	A57P1-62	-	-
25						

\*See text

Figure 3-21. HP 8410 Interface (2 of 2)

**DESCRIPTION**

The HP 8755C Scalar Network Analyzer is connected to the HP 8341A at this connector.

**PANEL LAYOUT**

8755C  
ALT SWP  
INTERFACE

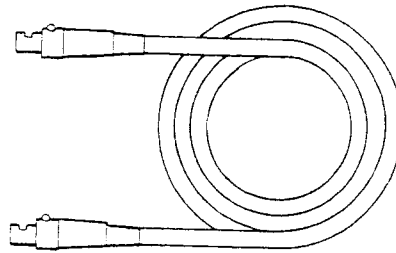
**FUNCTIONS**

Connect the HP 8755C Scalar Network Analyzer to the HP 8341A at this connector, using Interface Cable 8120-3174, to provide the alternate sweep function. An Operating Guide at the end of Section III explains the HP 8755C to HP 8341A interconnections. The pin configuration and electrical requirements for this connector are described in Section VIII (Service) of this Manual.

Figure 3-22. HP 8755C Interface



## DESCRIPTION

Maintenance of the filter element for the fan is described in this Figure.

## PANEL LAYOUT

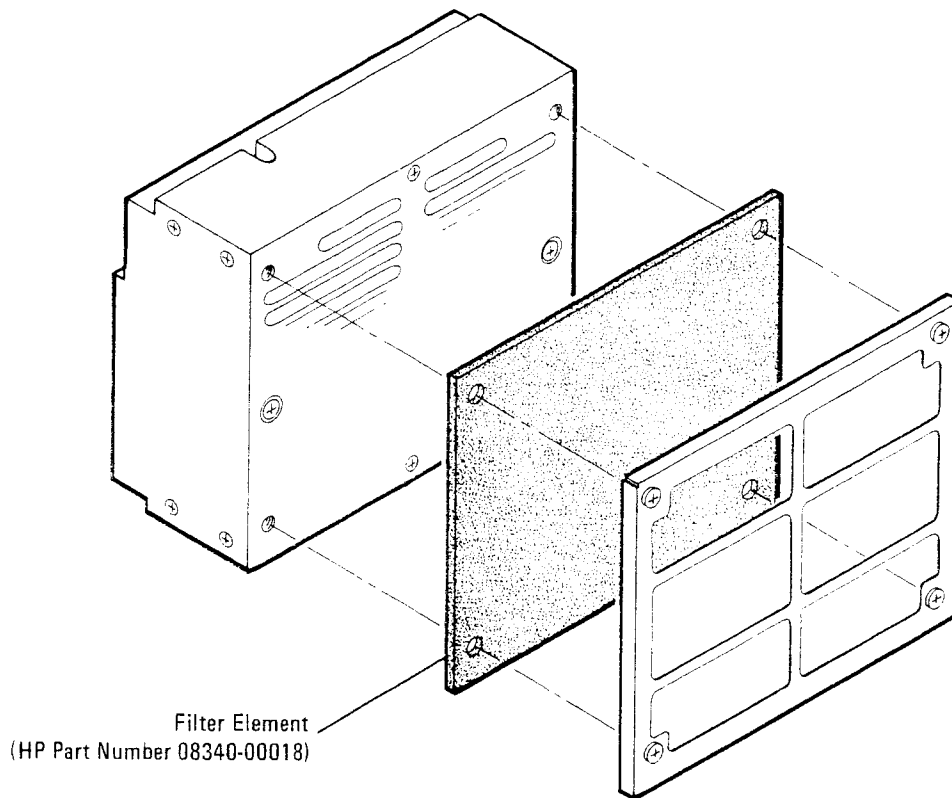

## FUNCTIONS

The foam filter element requires regular inspection and cleaning. The cooling fan for the HP 8341A is powerful, and pulls a large amount of air through its filter element; subsequently, the filter element collects dust, smoke, and other contaminants even from environments that seem quite clean. To prevent impaired cooling from a dirt-clogged filter, it is imperative that the filter be inspected regularly, and replaced as needed. (Filter replacement is recommended; cleaning, by vacuuming or washing and drying, is recommended only if a replacement filter is not available.). Section VI (Replaceable Parts) contains a complete parts listing for the fan, in the BI Fan Assembly pictorial.

## DESCRIPTION

The line power module contains a safety fuse, and a PC card that is used as a switch to match the HP 8341A's power supply to the locally available ac power.

## PANEL LAYOUT

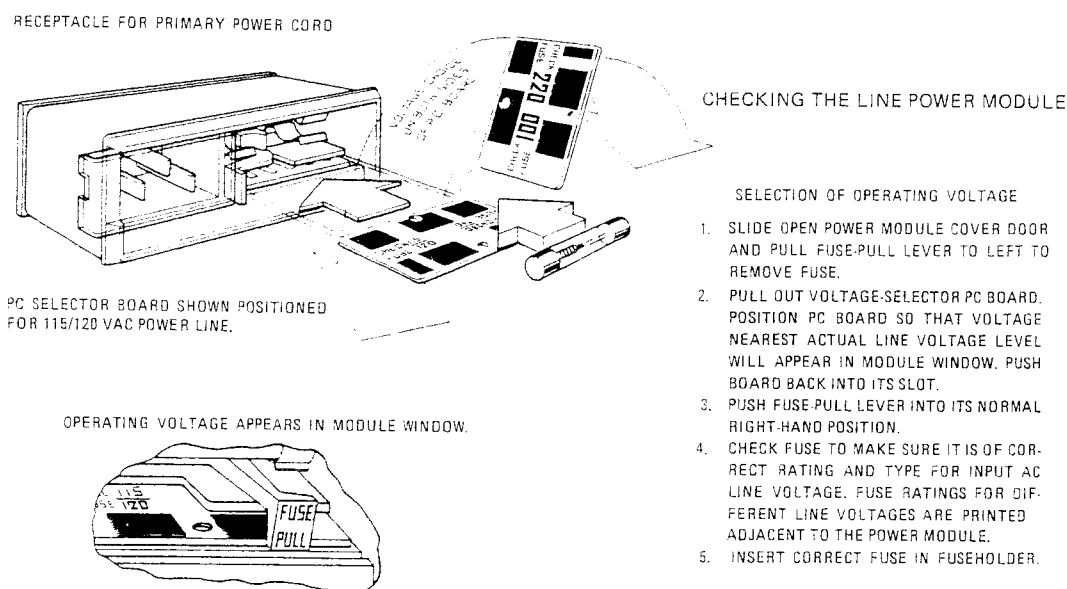

## FUNCTIONS

The HP 8341A requires a maximum of 500 VA of electrical power (40 VA in STANDBY) that is delivered to the instrument through the line power module. The module setting must match the locally available voltage, and be fused to provide a measure of safety to the instrument and the operator.

To determine the module's voltage setting, first measure the locally available ac power source. The HP 8341A requires either 100, 120, 200, or 240 volts with a tolerance of  $\pm 10\%$ . The HP 8341A also requires an ac frequency of 47.5 Hz to 66 Hz. Some installations may need an autotransformer and/or frequency converters to meet the voltage and frequency requirements. After obtaining suitable voltage and ac frequency, position the PC selector card as shown in the accompanying illustration.

The proper fuse rating also corresponds to the voltage selection, and these ratings are printed on the rear panel of the HP 8341A adjacent to the line power module (the fuses are also listed in Section II (Installation) of this Manual).

Appropriate power line cords are listed in Section II (Installation).

## HP-IB PROGRAMMING

### Introduction

HP-IB, the Hewlett-Packard Interface Bus, is the instrument-to-instrument communication system between the HP 8341A and up to 14 other instruments. Any instrument having HP-IB capability can be interfaced to the HP 8341A, including non-HP instruments that have "GPIB," "IEEE-488," "ANSI MC1.1," or "IEC-625" capability (these are common generic terms for HP-IB; all are electrically equivalent although IEC-625 uses a unique connector). This portion of the manual specifically describes interfacing the HP 8341A to one very special type of instrument: a computer.

### Interconnective Cabling

Figure 3-20 shows the HP 8341A's rear-panel HP-IB connector and suitable cables, and describes the procedures and limitations for interconnecting instruments. Cable length restrictions, also described in Figure 3-20, must be observed to prevent transmission line propagation delays that might disrupt HP-IB timing cycles.

### Instrument Addresses

Each instrument in an HP-IB network must have a unique address, ranging in value from 00-30 (decimal). The default address for the HP 8341A is 19, but this can be changed by the [SHIFT] [LOCAL] function as described in Figure 3-12 (the examples in this section use 19 as the address for the HP 8341A). Other instruments use a variety of procedures for setting the address, as described in their operating manuals, but typically either a rear panel switch or a front panel code is used.

### HP-IB Instruments Nomenclature

HP-IB instruments are categorized as "listeners," "talkers," or "controllers," depending on their current function in the network.

**LISTENER** is a device that is capable of receiving data or commands from other instruments. Any number of instruments in the HP-IB network can simultaneously be listeners.

**TALKER** is a device that is capable of transmitting data or commands to other instruments. To avoid confusion, an HP-IB system allows only one device at a time to be an active talker.

**CONTROLLER** is an instrument, typically a computer, that is capable of managing the various HP-IB activities. Only one device at a time can be an active controller.

### Programming the HP 8341A

The HP 8341A can be entirely controlled by a computer (although the line POWER switch must be operated manually). All functions that are initiated by front panel keystrokes (local operation) can also be initiated by an HP-IB computer; additionally, several functions are possible only by computer (remote) control. Computer programming procedures for the HP 8341A involve selecting an HP-IB command statement, then adding the specific HP 8341A programming codes to that statement to achieve the desired operating conditions. The programming codes can be categorized into two groups: Those that mimic front panel keystrokes, and the unique codes that are used for remote control.

In the programming explanations that follow, specific examples are included that are written in a generic dialect of the BASIC language. BASIC was selected because the majority of HP-IB computers have BASIC language capability; however, other languages can also be used. Hewlett-Packard publishes a series of Programming Notes that contain computer-specific, language-specific information for those wishing to use another language; contact the nearest HP Sales and Service Office (listed inside of the back cover) for a list of HP 8341A Programming Notes.

### HP-IB Command Statements

Command statements form the nucleus of HP-IB programming; they are understood by all instruments in the network and, when combined with instrument-specific codes, they provide all management and data communications instructions for the system.

An explanation of the fundamental command statements follows. However, some computers use a slightly different terminology, or support an extended or enhanced version of these commands. Consider the following explanations as a starting point, but for detailed information consult the BASIC language reference manual, the I/O programming guide, and the HP-IB manual for the particular computer being used.

Syntax drawings accompany each statement: All items enclosed by a circle or oval are computer-specific terms that must be entered exactly as described; items enclosed in a rectangular box are names of parameters used in the statement; and the arrows indicate a path that generates a valid combination of statement elements.

Here are the eight fundamental command statements:

**ABORT** abruptly terminates all listener/talker activity on the interface bus, and prepares all instruments to receive a new command from the controller. Typically, this is an initialization command used to place the bus in a known starting condition. The syntax is

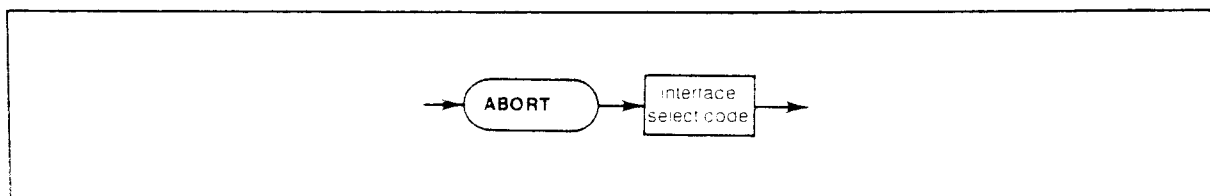

where the interface select code is the computer's HP-IB I/O port, which is typically port 7. Some BASIC examples:

```
10 ABORT 7
```

```
100 IF V > 20 THEN ABORT 7
```

Related statements used by some computers:

ABORTIO (used by HP-30 series computers)

HALT

RESET

**REMOTE** causes an instrument to change from local control to remote control. In remote control, the front panel keys are disabled (except for the [**LOCAL**] key and the POWER switch), and the amber REMOTE annunciator is lighted in the ENTRY DISPLAY. The syntax is

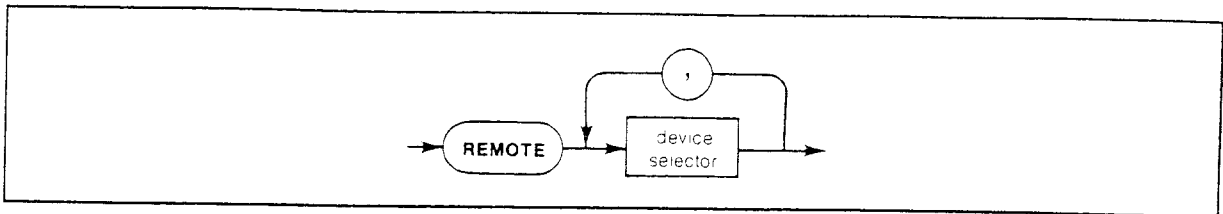

where the device selector is the address of the instrument appended to the HP-IB port number. Typically, the HP-IB port number is 7, and the default address for the HP 8341A is 19, so the device selector is 719. Some BASIC examples:

10 REMOTE 7

which prepares all HP-IB instruments for remote operation (although nothing appears to happen to the instruments until they are addressed to talk), or

10 REMOTE 719

which effects the HP-IB instrument located at address 19, or

10 REMOTE 719, 721, 726, 715

which effects four instruments that have addresses 19, 21, 26, and 15.

Related statements used by some computers:

RESUME

**LOCAL LOCKOUT** can be used in conjunction with REMOTE to disable the front panel [**LOCAL**] key. With the [**LOCAL**] key disabled, only the controller (or a hard reset by the POWER switch) can restore local control. The syntax is

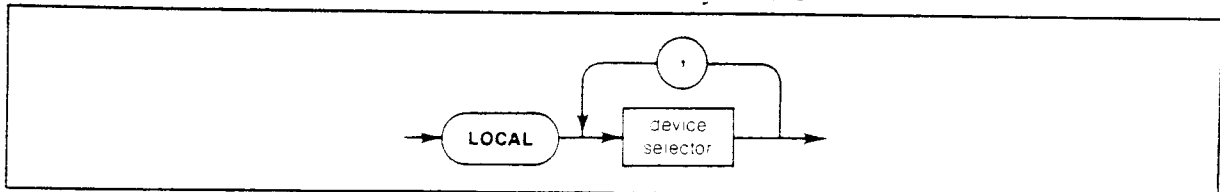

A BASIC example:

10 REMOTE 719

20 LOCAL LOCKOUT 7

**LOCAL** is the complement to REMOTE, causing an instrument to return to local control with a fully enabled front panel. LOCAL syntax is

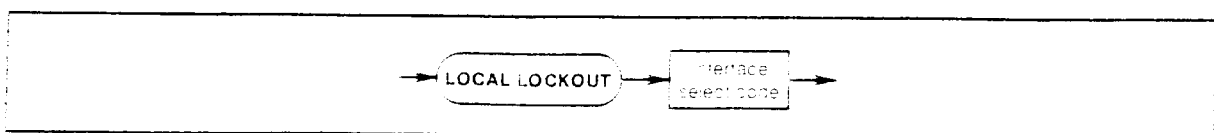

Some BASIC examples:

```
10 LOCAL 7
```

which effects all instruments in the network, or

```
10 LOCAL 719
```

for an addressed instrument (address 19).

Related statements used by some computers:

RESUME

**CLEAR** causes all HP-IB instruments, or addressed instruments, to assume a "cleared" condition, with the definition of "cleared" being unique for each device. For the HP 8341A:

1. Both status bytes are reset to zero.
2. All pending output-parameter operations, such as those associated with the **OA**, **OP**, and **OR** codes, are halted.
3. The parser (the software that interprets the programming codes) is reset, and now expects to receive the first character of a programming code.

The syntax is

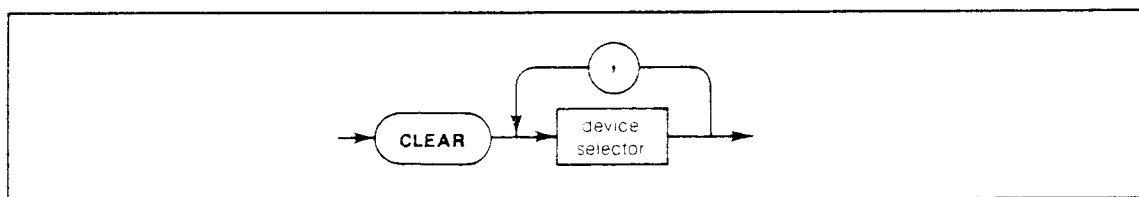

Some BASIC examples:

```
10 CLEAR 7
```

to clear all HP-IB instruments, or

```
10 CLEAR 719
```

to clear an addressed instrument.

Related statements used by some computers:

RESET  
CONTROL  
SEND

**TRIGGER** initiates a single event, such as a single sweep or an instantaneous measurement, from all instruments or an individually addressed instrument. If the HP 8341A is in analog-sweep mode TRIGGER starts the sweep; if in CW, manual sweep, or fast phaselock (code FP) mode TRIGGER increments the frequency. When the upper frequency limit is reached (either the stop frequency for swept modes, or 20 GHz for CW mode) the next TRIGGER command will initiate a retrace to the starting frequency. The syntax is

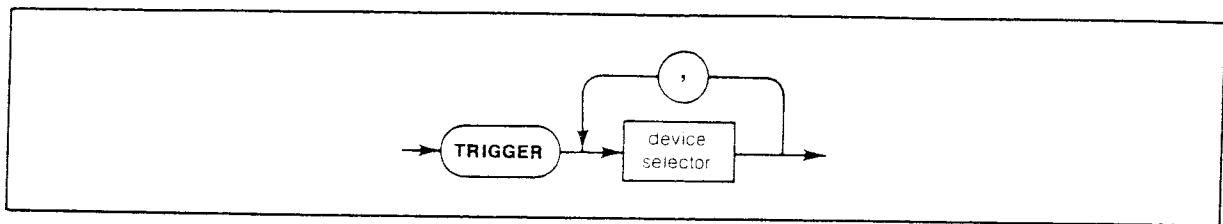

A BASIC example:

to simultaneously trigger all HP-IB instruments, or

100 TRIGGER 719

to trigger an instrument at address 19, or

100 TRIGGER 719, 721, 712

to trigger instruments at addresses 19, 21, and 12.

Related statements used by some computers:

RESUME

SEND

The preceding statements are primarily management commands that do not incorporate instrument-specific programming codes. The following two statements do incorporate programming codes, and are used for data communication.

**OUTPUT** is used to send function commands and data commands from the controller to the addressed instrument. The syntax is

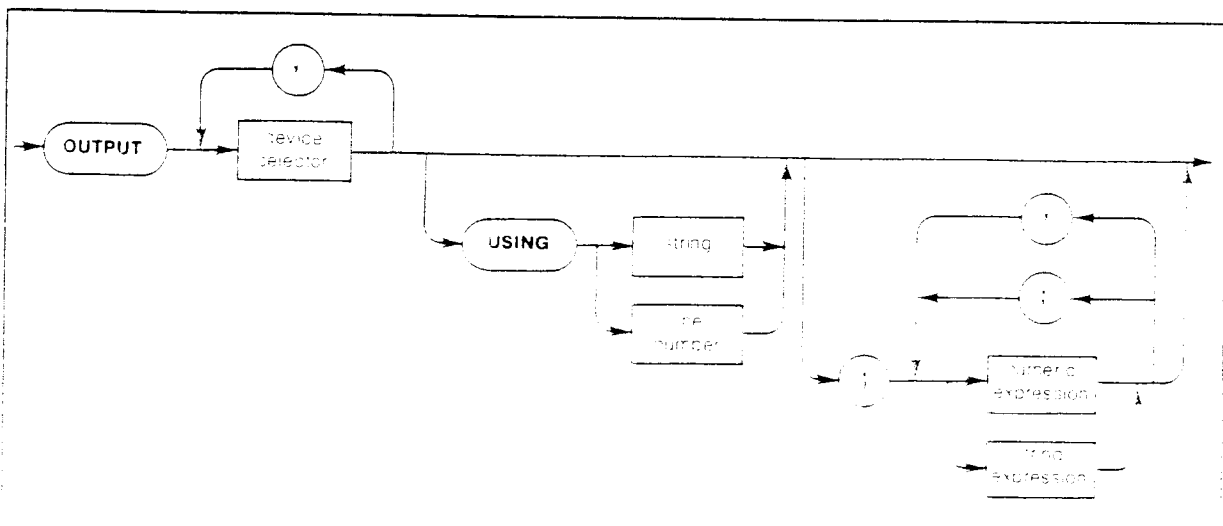

where USING is a secondary command that formats the output in a particular way, such as binary or ASCII representation of numbers. The USING command is followed by "image items" that precisely define the format of the output; these image items can be a string of code characters, or a reference to a statement line in the computer program. Image items are explained in the programming codes where they are needed. Notice that this syntax is virtually identical with the syntax for the ENTER statement that follows. A BASIC example:

100 OUTPUT 719: "programming codes"

The many programming codes for the HP 8341A are listed in Tables 3-1 and 3-2, and are explained in the Programming Codes subsection.

Related statements used by some computers:

- CONTROL
- CONVERT
- IMAGE
- IOBUFFER
- TRANSFER

**ENTER** is the complement to OUTPUT, and is used to transfer data from the addressed instrument to the controller. The syntax is

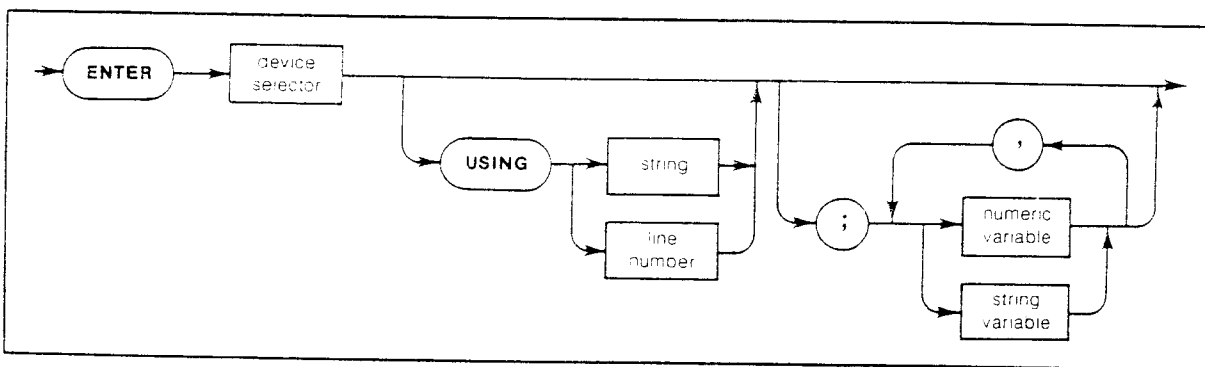

ENTER is always used in conjunction with OUTPUT, such as:

100 OUTPUT 719: "... programming codes ..."  
 110 ENTER 719: "... complementary codes ..."

ENTER statements are commonly formatted, which requires the secondary command USING and the appropriate image items. The most-used image items involve end-of-line (EOL) suppression, binary inputs, and literal inputs. For example,

100 ENTER 719 USING "#, B": A, B, C

suppresses the EOL sequence (#), and indicates that variables A, B, and C are to be filled with binary (B) data. As another example,

100 ENTER 719 USING "#, 123A": AS

suppresses EOL, and indicates that string variable AS is to be filled with 123 bytes of literal data (123A). Note: Be careful when using byte-counting image specifiers, because if the requested number of bytes does not match the actual number available data might be lost, or the program might enter an endless wait state.



The suppression of the EOL sequence is frequently necessary to prevent a premature termination of the data input. When not specified, the typical EOL termination occurs when an ASCII LF (line feed) is received. However, the LF bit pattern could coincidentally occur randomly in a long string of binary data, where it might cause a false termination. Also, the bit patterns for the ASCII CR (carriage return), comma, or semicolon might cause a false termination. Suppression of the EOL causes the computer to accept all bit patterns as data, not commands, and relies on the HP-IB EOI (end or identify) line for correct end-of-data termination.

The various programming codes that are associated with the ENTER statement are listed in Tables 3-1 and 3-2, and are explained in the Programming Codes subsection.

Related statements used by some computers:

CONVERT  
IMAGE  
IOBUFFER  
ON TIMEOUT  
SET TIMEOUT  
TRANSFER

This completes the HP-IB Command Statements subsection. The following material explains the HP 8341A programming codes, and shows how they are used with the OUTPUT and ENTER HP-IB command statements.

### HP 8341A Programming Codes

Table 3-1 lists the HP 8341A programming codes arranged by function, and Table 3-2 lists the codes alphabetically. Notice in the Tables that several codes correspond to keys on the front panel of the HP 8341A: All front panel operations (except the POWER switch) can be duplicated by a remote computer program, and those are the programming codes that are used to replace the keystrokes. There are also several programming codes listed in the Tables that are unique to HP-IB operation. The next two subsections describe all of these codes, first by explaining how front panel operations can be duplicated, and then explaining the unique HP-IB operations.

#### Programs that Duplicate Front Panel Operations

Any HP 8341A operation that can be established by pressing keys on the front panel can be duplicated by a computer program, with the exception of the POWER switch function. This is the procedure:

1. Determine the keystroke sequence needed for the desired operation. For example, this sequence establishes a 2.3 GHz CW signal at -10 dBm:

```
[INSTR PRESET] [CW] [2] [.] [1] [GHz] [POWER LEVEL] [-] [1] [0] [dB(m)]
```



Table 3-2. HP 8340A Programming Codes (1 of 4)

Code	Operation Performed	Equivalent Key	Ref. Figure
A1	Leveling, internal	[INT]	3-16
A2	Leveling, external	[XTAL]	3-16
A3	Leveling, power meter	[METER]	3-16
AK m	Amplitude marker	[AMTD MKR]	3-17
AL m n	Alternate state	[ALT]	3-12
AM m	Amplitude modulation	[AM]	3-14, 3-15
AS m	Alternate state select		
AT d	Attenuator		
AU	Auto	[Hz/Auto]	3-10
BC	Change frequency band		
CF d t	Center frequency	[CF]	3-7
CS	Clear both status bytes		
CW d t	CW frequency	[CW]	3-7
DB	dB(m) terminator	[GHz/dB(m)]	3-10
DF d t	Delta frequency	[ΔF]	3-7
DN	Down step	[▼]	3-8
DU m	Display updating (= SHS1)		
EF	Entry Display off	[ENTRY OFF]	3-8
EK	Enable rotary knob		
FA d t	Start frequency	[START FREQ]	3-7
FB d t	Stop frequency	[STOP FREQ]	3-7
FP *	Fast phaselock		
GZ	GHz terminator	[GHz/dB(M)]	3-10
HZ	Hz terminator	[Hz/AUTO]	3-10
IF	Increment frequency		
IL 123b	Input learn data		
IP	Instrument preset	[INSTR PRESET]	3-12
KR	Keyboard release		
KZ	kHz terminator	[kHz/msec]	3-10
M0	Marker off (=M0)	[OFF]	3-9
M1 d t	Marker 1 on	[M1]	3-9
M2 d t	Marker 2 on	[M2]	3-9
M3 d t	Marker 3 on	[M3]	3-9
M4 d t	Marker 4 on	[M4]	3-9
M5 d t	Marker 5 on	[M5]	3-9
MC	Marker to center frequency	[MKR → CF]	3-9
MD m	Marker delta	[MKR Δ]	3-9
MO	Marker off (=M0)	[OFF]	3-9
MP m	Marker sweep, M1-M2	[MKR SWEEP]	3-9
MS	milliseconds terminator	[kHz/msec]	3-10
MZ	MHz terminator	[MHz/sec]	3-10
NA 1b	Network analyzer configure		
OA (d)	Output active parameter		
OB (d)	Output next band frequency		
OC (3d)	Output coupled parameters		
OD *	Output diagnostic values		
OF (d)	Output fault values		
OI (19a)	Output identification		
OK (d)	Output last lock frequency		

Table 3-2. HP 8340A Programming Codes (2 of 4)

Code	Operation Performed	Equivalent Key	Ref. Figure
OL (123b)	Output learn data		
OM (8b)	Output mode data		
OP (d)	Output interrogated parameter		
OR (d)	Output power level		
OS (2b)	Output status bytes		
PL d t	Power level	[POWER LEVEL]	3-7
PM m	Pulse modulation (Opt. 006)	[PULSE]	3-14, 3-15
PS m	Power sweep	[PWR SWP]	3-17
RB 1b	Remote rotary knob		
RC n	Recall instrument state	[RECALL] [0-9]	3-12
RE 1b	Extended status byte mask		
RF m	RF output on/off	[RF]	3-17
RM 1b	Status byte mask		
RP m	RF peaking	[PEAK]	3-17
RS	Reset sweep		
S1	Sweep, continuous	[CONT]	3-11
S2	Sweep, single	[SINGLE]	3-11
S3	Sweep, manual	[MANUAL]	3-11
SC	seconds terminator	[MHz/sec]	3-10
SF d t	Step frequency size		
SG	Sweep, single		
SH	Shift prefix	[SHIFT]	3-7
SHA1	Jump to next bandcross	[SHIFT] [INT]	3-16
SHA2 m	Band crossing diagnostic	[SHIFT] [XTAL]	3-16
SHA3 d t	Access linear modulator	[SHIFT] [METER]	3-17
SHAK	Immediate YTM peak	[SHIFT] [AMTD MKR]	3-17
SHAM m	Pulse modulation enhancement	[SHIFT] [AM]	3-14
SHCF d t	Set frequency step size	[SHIFT] [CF]	3-7
SHCW *	CW increment resolution	[SHIFT] [CW]	3-7
SHFA d t	Display multiplier	[SHIFT] [START FREQ]	3-7
SHFB d t	Display offset	[SHIFT] [STOP FREQ]	3-7
SHM1	Diagnostic: M/N, 20/30 frequency	[SHIFT] [M1]	3-9
SHM2	Diagnostic: band, YO	[SHIFT] [M2]	3-9
SHM3	Diagnostic: VC01, VC02 frequencies	[SHIFT] [M3]	3-9
SHM5	Turn off diagnostics	[SHIFT] [M5]	3-9
SHMO	Turn off all markers	[SHIFT] [OFF]	3-9
SHMP	Marker sweep, M1-M2	[SHIFT] [MKR SWEEP]	3-9
SHPL d t	Set power level step	[SHIFT] [POWER LEVEL]	3-7
SHPS d t	Decouple ATN, ALC	[SHIFT] [PWR SWP]	3-17
SHRC	Remove save-lock	[SHIFT] [RECALL]	3-12
SHS1 m	Blank displays	[SHIFT] [CONT]	3-11
SHS3	Display fault diagnostic	[SHIFT] [MANUAL]	3-11
SHSL d t	Control reference level	[SHIFT] [SLOPE]	3-17
SHST d t	ZOOM function	[SHIFT] [SWEEP TIME]	3-7
SHSV	Lock save/recall	[SHIFT] [SAVE]	3-12
SHRP	Tracking calibration	[SHIFT] [PEAK]	3-17
SHT1	Test displays	[SHIFT] [FREE RUN]	3-11
SHT2 m	Bandcrossing penlit	[SHIFT] [LINE]	3-11
SHT3	Display unlock indicators	[SHIFT] [EXT]	3-11



Table 3-2. HP 8340A Programming Codes (3 of 4)

Code	Operation Performed	Equivalent Key	Ref. Figure
SHGZ d t	IO channel	[SHIFT] [GHz/dB(m)]	3-10
SHMZ d t	IO subchannel	[SHIFT] [MHz/sec]	3-10
SHKZ d t	Write to IO	[SHIFT] [kHz/msec]	3-10
SHHZ	Read from IO	[SHIFT] [Hz/AUTO]	3-10
SL m d t	Power slope	[SLOPE]	3-17
SM d t	Sweep, manual		
SN d t	Steps, maximum		
SP d t	Set power step size		
ST d t	Sweep time	[SWEEP TIME]	3-7
SV n	Save instrument state	[SAVE] [1-9]	3-12
SW m	Swap network analyzer channels		
T1	Trigger, free run	[FREE RUN]	3-12
T2	Trigger, line	[LINE]	3-12
T3	Trigger, external	[EXT]	3-12
TI b (b)	Test HP-IB interface		
TL d t	Time limit		
TS	Take sweep		
UP	Up step	[▲]	3-8

**Note:** The HP 8341A automatically upshifts codes entered in lower case, and ignores spaces placed between codes groups. The warning message "HP-IB SYNTAX ERROR" appears in the ENTRY DISPLAY if an error is made in the programming format, and the HP 8341A will ignore the unrecognized code characters. (The HP 8341A also clears HP-IB DIO line 8, which sometimes is used as a parity bit; HP-IB lines are explained later in this Section.)

The lower-case letters listed after the codes indicate typical suffix parameters, as follows:

If no suffix follows a code in this Table, the code represents either a self-contained, immediate execute function, or one of the terminator codes that scale and define the associated numerical data.

- a** indicates that alphanumeric ASCII characters are associated with this code.
- b** indicates binary information consisting of 8-bit bytes. Typically, binary information is transmitted by using either the computer's CHR\$ function (which converts a decimal number to a string of binary bytes), such as

```
100 OUTPUT 719: "... code..."&CHR$(decimal)
```

where the "&" concatenates the CHR\$ function to the programming code (and prevents an end-of-line terminator from being placed between the code and the data), or for codes that require strings of binary data an image specifier can be used; for example:

```
100 OUTPUT 719: "... programming code...";
110 OUTPUT 719 USING "#, B": byte(s)
```

The final semicolon in line 100 inhibits an end-of-line sequence from the computer (an EOL must not separate code from data). The "#" in line 110 suppresses EOL that might occur between data bytes or from a coincidental data bit pattern that mimics an EOL sequence, and the "B" indicates that the subsequent variables represent binary data.

Table 3-2. HP 8340A Programming Codes (4 of 4)

<b>d</b>	indicates decimal data, which is allowed any of these data formats:  single digit: ±d Integer, decimal: ±d***d Real, decimal: ±d***d.d***d Exponential, decimal: ±d***d.d***dE±dd
<b>m</b>	indicates that a "1" or a "0" must follow the code letters, where the 1 suffix is usually used to turn on the function, and the 0 suffix turns off the function.
<b>n</b>	is a single digit, 1-9 for SV and 0-9 for RC, which indicates the desired memory register.
<b>t</b>	indicates that a terminator is required. Typically, the programming codes GZ, MZ, KZ, HZ, DB, SC, and MS are used as terminators because they also serve as units scalars. Alternatively, a comma or an ASCII LF (decimal 10) can be used as a terminator, which will cause the HP 8341A to scale the corresponding function to the fundamental units of Hertz, seconds, or dB(m).
(. . .)	parenthesis indicate codes that cause the HP 8341A to output information for a subsequent input by the computer, with the format of the information being indicated by the parenthetical letters. For example, code listing OC (3d) indicates that 3 decimal values should be read as a result of the OC command:  100 OUTPUT 719: "OC" 110 ENTER 719: A, B, C  As another example, code listing OM (8b) indicates that 8 binary bytes should be read:  100 OUTPUT 719: "OM" 110 ENTER 719 USING "#, B": B1, B2, B3, B4, B5, B6, B7, B8  (The image parameters in line 110 are explained in the preceding "b - binary data" section.)
*	follows the codes that have special suffix requirements; consult the detailed explanation of the code for further information.



2. Use the Information Cards (located beneath the front panel), or Tables 3-1 and 3-2, to find the programming code for each key. Continuing with the example,

Key	Programming Code
[INSTR PRESET]	IP
[CW]	CW
[2]	2
[.]	.
[3]	3
[GHz]	GZ
[POWER LEVEL]	PL
[−]	−
[1]	1
[0]	0
[dB(m)]	DB

3. Combine the programming codes into an OUTPUT command. For an HP 8341A having address 19, this is the complete program:

```

10  ABORT 7
20  CLEAR 7
30  OUTPUT 719; "IPCW2.3GZPL-10DB"
40  END

```

ABORT, CLEAR, and IP are not always required, but it is good programming practice to use them (in this sequence) because they place the HP 8341A in a completely reset, standard operating condition.

The HP 8341A automatically upshifts lower-case characters, and ignores spaces and unassigned characters; therefore, line 30 in the preceding program could be written as follows, resulting in enhanced readability at a slight cost in execution time:

```

30  OUTPUT 719; "IP    CW 2.3 Gz    PL -10 dB"

```

Or the information could be written

```

30  OUTPUT 719; "IP"
40  OUTPUT 719; "CW 2.3 Gz"
50  OUTPUT 719; "PL -10 dB"
60  END

```

For interactive programs, the frequencies, power level, and other numerical data can be placed in the OUTPUT statement as variables. For example:

```

30  OUTPUT 719; "IP"
40  OUTPUT 719; "CW 2.3 Gz"
50  PRINT "ENTER THE POWER LEVEL"
60  INPUT P
70  OUTPUT 719; "PL":P:"Gz"
80  GO TO 50
90  END

```

### Using the Rotary KNOB

The rotary **[KNOB]** can also be enabled for interactive programs. The **[KNOB]** is normally disabled when the HP 8341A is in REMOTE; however, the "EK" programming code re-enables the **[KNOB]**:

```

80  REM    EK ALLOWS THE KNOB TO CONTROL PL
90  OUTPUT 719; "EKPL"
100 PAUSE
110 REM    EK ALLOWS THE KNOB TO CONTROL CW
120 OUTPUT 719; "EKCW"
130 END

```

The "EK" can precede or follow the programming code for the function key; that is, "EKCW" and "CWEK" are functionally equivalent. If EK is output by itself, the **[KNOB]** will control the last-activated function:

```

80  OUTPUT 719; "FA10GZ    FB14GZ    PL-10DB    ST100MS"
90  OUTPUT 719; "EK"
100 END

```

Line 80 establishes a start frequency of 10 GHz, stop frequency of 14 GHz, power level of -10 dBm, and a sweep time of 100 milliseconds. Line 90 enables the **[KNOB]**, which will control the sweep time since that was the last-activated function.

### Using Keys that Toggle ON/OFF

Several keys, such as the MODULATION keys, activate functions that are either ON or OFF. To turn a function ON or OFF, add a "0" (OFF) or "1" (ON) suffix to the key's programming code. For example:

```

200 REM    TURN THE "AMTD MKR" ON
210 OUTPUT 719; "AK1"
220 PAUSE
230 REM    TURN THE "AMTD MKR" OFF
240 OUTPUT 719; "AK0"

```

### Operator's Programming Check

To check the various programming codes that duplicate front panel operations, enter this BASIC program (or equivalent):

```

10  DIM AS[60]
20  REMOTE 719
30  PRINT "ENTER PROGRAMMING CODES"
40  INPUT AS
50  OUTPUT 719; AS
60  GOTO 30
70  END

```

RUN the program, and enter any combination of programming codes (60 characters maximum) when prompted: for example:

ENTER PROGRAMMING CODES ?

FA12GZ FB18GZ PL-13DB STAU (followed by RETURN or END LINE)



The HP 8341A should immediately respond to your commands with, in this example, a 12 GHz start frequency, 18 GHz stop frequency, power level of  $-13$  dBm, and a sweep time set to auto (auto selects the fastest possible sweep rate for a given frequency span).

The preceding applications of the **OUTPUT** command are sufficient for writing computer programs that duplicate all front panel operations. The next subsection explains programming codes that do not have an equivalent key on the front panel.

### Unique HP-IB Programming Codes

Several programming codes are available which do not have an equivalent front panel key; these codes are listed in Table 3-2 and described here, in alphabetical order (the lower case letters that follow each code mnemonic are explained in Table 3-2).

**ASm** Alternate State Select, is primarily used when the HP 8341A is operating in certain network analyzer systems. AS is always used in conjunction with alternate state mode ([**ALT**], Figure 3-12) where it causes an abrupt change from one operational state to the other. Use AS when automatic alternation does not occur (for example, when CW mode is used for one or both operational states), or when it might be necessary to interrupt the alternating operation.

First, establish alternating operation between the present operating configuration (called the "foreground" state) and one of the previously **SAVED** operating configurations (called the "background" state). For example, code **AL13** activates alternating operation between the foreground and background states, with the background state being derived from the contents of memory register 3 (the code parameters are **ALnx**, where  $n=1/0$  to activate/deactivate alternating operation, and  $x=1-9$  indicates the memory register that will be transferred to the background register).

With alternating mode in effect, AS is used to abruptly change the operating state: **AS0** causes the present HP 8341A operation (whether that operation is foreground or background) to abruptly halt, retrace to the beginning of the foreground state, and begin operating under the foreground configuration; **AS1** causes the present operation to abruptly halt, retrace to the beginning of the background state, and begin operating under the background configuration. After the AS-initiated foreground or background change has been completed, the previously established alternating state operation resumes. A BASIC example:

```

100 REM PREPARE BACKGROUND STATE, SAVE IN REGISTER 3
110 OUTPUT 719: ". . . (programming codes) . . .SV3"
120 REM
130 REM PREPARE FOREGROUND STATE, AND ALTERNATE
140 OUTPUT 719: ". . . (programming codes) . . .AL13"
150 REM
160 REM ABRUPTLY CHANGE STATES IF NECESSARY
170 IF X > Y THEN OUTPUT 719: "AS1"
180 IF X < Y THEN OUTPUT 719: "AS0"

```

(X and Y in lines 170 and 180 are arbitrary variables for a hypothetical test.)

**ATd** Attenuator (Options 001, 004), allows the attenuator to be set remotely, and is used when the attenuator is uncoupled from the ALC (SHSL initiates the uncoupling). The standard attenuator (see the attenuator options listed in Section I) has a range of 0 to  $-90$  dB in 10 dB increments: set the attenuator by using the code **ATxDB**, where x is the numerical value (the HP 8341A will round values to the nearest 10 dB) and DB is the terminator. A BASIC example:

```

100 OUTPUT 719: "AT-40DB"

```

**BC** Band Change, causes the HP 8341A to advance to the next frequency bandcrossing point. The BC code is used in two situations: 1) It is used when the HP 8341A is in network analyzer mode (the NA programming code), or 2) it is used when automatic bandcrossing has been disabled by the SHA21 code (in this case, the BC code functions identically to the SHA1 code; bandcross disabling and the SHA1/SHA2 functions are described in Figure 3-16).

**CS** Clear Status bytes, resets to zero the 16 bits in the two status bytes. Any status bit that is in the process of being set, but was deferred pending completion of some function, will also be cleared by CS. Status bytes, along with the CS code, are explained under the OS (Output Status byte) code.

**DUm** Display Updating, blanks (DU0) or unblanks (DU1) the front panel displays of the HP 8341A, and is identical in function to SHS1m ([**SHIFT**] [**CONT**], which is described in Figure 3-11). In automated systems the displays of the HP 8341A might be redundant, and can be blanked to reduce visual distractions for the operator. A BASIC example:

```
100 OUTPUT 719: "DU0"
```

If DU1 is output while the HP 8341A is in the middle of a sweep, the sweep will abruptly stop, retrace, and then resume sweep operations.

**EK** Enable Knob, activates the rotary [**KNOB**] on an otherwise remote HP 8341A front panel. Once the [**KNOB**] is enabled it is automatically coupled to the presently active function, such as:

```
100 OUTPUT 719: "CWEK"           ([KNOB] adjusts CW frequency)
```

```
200 OUTPUT 719: "PLEK"           ([KNOB] adjusts Power Level)
```

In the above examples, the CW and PL function codes were output along with EK to explicitly specify the active function; since no data accompanied the function codes, the last-used data values (or the IP default values) will be re-established. EK can also be output alone:

```
300 OUTPUT 719: "EK"
310 OUTPUT 719: "CF70MZ"
320 PAUSE
330 OUTPUT 719: "DF1MZ"
340 PAUSE
350 OUTPUT 719: "ST50MS PL-15DB"
360 PAUSE
```

EK always controls the active function; hence, at line 320 the [**KNOB**] controls the center frequency (initially at 70 MHz); at line 340 the [**KNOB**] controls the delta frequency (initially at 1 MHz); and at line 360 the [**KNOB**] controls the power level (initially at -15 dBm). Notice at line 360 that the [**KNOB**] controls PL, not ST, because PL is the last-activated function.

**FP** Fast Phaselock, is used when the fastest possible frequency transition is necessary between CW frequencies. FP can be used for fast transitions between steps in a stepped CW sweep, or it can be used when the CW frequencies must be rapidly changed to any value in the 10 MHz to 20 GHz frequency span of the HP 8341A.

FP achieves rapid frequency transition by limiting some of the normal HP 8341A features: The plotter control functions are disabled, the 0-10 volt sweep ramp is frozen, and the HP 8341A does not wait for a complete locking of the phase lock loop oscillators before releasing the HP-IB handshake. The FP code must have a numerical suffix (14 characters maximum) in Hz units, without any terminator code (ASCII "LF," normally sent by the computer, is the only allowable terminator), that sets the starting frequency. A BASIC example of a stepped CW sweep:

```
100 OUTPUT 719: "IP SF1KZ CW"
110 OUTPUT 719: "FP1E9"
120   FOR J = 1 TO 100
130   TRIGGER 719
140   NEXT J
150 GOTO 110
```

Line 100 sets the step size (SF) to 1 kHz, and causes the HP 8341A to enter CW mode (the unspecified CW frequency at this point will be the last used CW frequency, or the IP default value). Line 110 initiates fast phaselock mode, and establishes a starting CW frequency of 1E9 Hz (1 X 10<sup>9</sup> Hz, or 1 GHz). At this point in the program, the HP 8341A is outputting 1 GHz CW but will not increment until line 130 is reached. Line 150 causes a retrace to 1 GHz.

For irregular frequency steps use a variable to represent the numerical data, such as:

```
100 FOR N = 1 TO 4
110 READ A
120 OUTPUT 719: "FP":A
130 NEXT N
140 DATA 1E7, 1E8, 1E9, 1E10
```

Line 140 contains the list of frequencies (in Hz units; hence, 10 MHz, 100 MHz, 1 GHz, and 10 GHz) which are read in line 110. The semicolon between the "FP" and A (an arbitrary variable) in line 120 signifies to the computer that a terminator should not separate the code from the variable.

- IF** Increment Frequency, is similar to the HP-IB commands TRIGGER and GET (group execute trigger). IF must be used to trigger the SN function, and can be used to increment SM and other CW frequency functions (however, IF cannot be used to trigger FP). For example:

```
100 OUTPUT 719: "SF1GZ CW1GZ"
110 FOR N = 1 TO 20
120 OUTPUT 719: "IF"
130 NEXT N
```

The step size and the starting CW frequency are both set to 1 GHz in line 100. Lines 110 to 130 cause the CW frequency to increment 20 times (i.e., a 1-21 GHz stepped sweep).

- IL123b** Input Learn data, is used in conjunction with OL (Output Learn data) to save/recall various operating configurations of the HP 8341A. IL/OL is similar to the SAVE/RECALL functions, except with IL/OL the active function in use prior to OL storage is once again active after the IL restoration (no function is active after a RECALL), and there is virtually no limit to the number of instrument states that can be stored (SAVE/RECALL has a capacity of 9 memory registers, located in the HP 8341A; IL/OL data is stored in the computer's mass storage device). IL is explained under the OL programming code.

**KR** Keyboard Release, is used with the NA code. If NA bit 1 is set True (=1), the HP 8341A front panel keys are in a lock-and-release mode. In this mode, the keyboard is locked (disabled) after any one key has been pressed, and remains locked until released by the KR code. The typical loop program involves three steps: 1) Determine which key was pressed by using the OM code; 2) process the key closure information; 3) use KR to release the keyboard, and return to step 1.

**NA<sub>b</sub>** Network Analyzer configuration, establishes the operating modes that are used when the HP 8341A is interfaced with certain network analyzers. The modes are established by adding a binary or decimal number to the NA code, where the bits of the number are deciphered as follows:

Bit 0 set true (1):

Enable network analyzer mode with the following features:

1. Enable group-execute-trigger (GET) to start a sweep after a mid-sweep update, if in analog sweep mode.
2. Use Stop Frequency to calculate the end of the band.
3. Disable HP 8341A detection of sweep event markers, bandcrossing points, and sweep end point.
4. Do binary search to set sweep reset DAC.
5. Issue end of sweep SRQ for mid-sweep update.
6. Disable automatic alternation when alternating in manual or CW non-swept mode.
7. Ignore BC following mid-sweep updates, until next GET.

Bit 1 set true (1): Enable keyboard hold off, released by KR.

Bit 2 set true (1): Disable "HP-IB SYNTAX ERROR" annunciator that would otherwise appear in the ENTRY DISPLAY.

Bits 3-7: Not used.

Bit 0 is set true by decimal "1," bit 1 is set by decimal "2," and bit 2 is set by decimal "4." A BASIC example that sets bits 0, 1, and 2 true:

```
100 OUTPUT 719; "NA"&CHRS(7)
```

In this example, the binary value of decimal 7 (CHRS(7) ) is concatenated to the NA code (&). Alternatively, a formatted OUTPUT statement could be used to output the same binary information:

```
100 OUTPUT 719 USING "2A, B": "NA", 7
```

The image specifier "2A, B" indicates that two literal characters will be output, followed by a single binary byte.

Consult the Operating Guide for the specific network analyzer being used for detailed interfacing information.

**OA(d)** Output Active parameter, allows the computer to read the numerical value of the presently active HP 8341A function. The active function is the last-used function, and appears in an unblanked ENTRY DISPLAY. A BASIC example:

```
100 OUTPUT 719; "FA65MZ FB75MZ PL10DB ST1SC"
110 OUTPUT 719; "OA"
120 ENTER 719; A
130 PRINT "ACTIVE PARAMETER = "; A
```

Sweep time is the active parameter, because it was the last-entered function (line 100). The OA value read by the computer (read in line 120, and assigned to arbitrary variable A) is always in the fundamental units of Hz, dB(m), or seconds.

The OM code (byte 2) can be used to determine the presently active function.

**OB(d)** Output next Band frequency, indicates the frequency of the next bandcrossing. The HP 8341A has three bandcrossing points, at 2.4 GHz, 7.0 GHz, and 13.5 GHz. A BASIC example:

```
100 OUTPUT 719; "CW6GZ"
110 OUTPUT 719; "OB"
120 ENTER 719; A
130 PRINT "NEXT BANDCROSSING ";A/1E9;" GIGAHERTZ"
```

In this example, the HP 8341A is outputting a 6 GHz CW signal, so the next bandcrossing point is 7.0 GHz. The OB frequency is always in Hz; line 130 divides the OB value by  $1 \times 10^9$  for conversion to GHz units.

**OC(3d)** Output Coupled parameters, allows the computer to read the values of the start frequency, center frequency, and sweep times (in this order) of the HP 8341A. The values are always read in the fundamental units of Hz and seconds. In BASIC:

```
100 OUTPUT 719; "FA1GZ FB19GZ STAU"
110 OUTPUT 719; "OC"
120 ENTER 719; S,C,T
130 PRINT "START FREQUENCY";S/1E9;" GHZ"
140 PRINT "CENTER FREQUENCY";C/1E9;" GHZ"
150 PRINT "SWEEP TIME";T;" SECONDS"
```

The computer would display, for this example, a start frequency of 1 GHz, a center frequency of 10 GHz, and a sweep time of 0.030 seconds.

**OD** Output Diagnostic values, allows the computer to read the values that result from the diagnostic functions (always in the fundamental units of Hz, dB(m), or seconds). There are three diagnostic functions that can be used with OD:

1. Oscillator frequencies diagnostic: Programming code SHM1 (keystrokes **[SHIFT]** **[M1]**; see figure 3-9) activates this diagnostic, which outputs the M value, N value, M/N loop frequency, and the 20/30 loop frequency. In BASIC:

```
100 OUTPUT 719; "SHM1 OD"
110 ENTER 719; M,N,R,L
120 PRINT "M VALUE "; M
130 PRINT "N VALUE "; N
140 PRINT "M/N FREQUENCY "; R; " HZ"
150 PRINT "20/30 LOOP FREQ "; L; " HZ"
```

2. Band number and YIG oscillator diagnostic: Programming code SHM2 (key-strokes **[SHIFT] [M2]**; see Figure 3-9) causes the band number and YIG oscillator frequency to be output, in this order. In BASIC:

```
100 OUTPUT 719; "SHM2 OD"
110 ENTER 719; B, Y
120 PRINT "BAND NUMBER "; B
130 PRINT "YIG OSC FREQUENCY "; Y; " HZ"
```

3. Phase lock loop (PLL) frequencies diagnostic: Programming code SHM3 (key-strokes **[SHIFT] [M3]**; see Figure 3-9) causes the PLL #2 VCO frequency and the PLL #3 upconverter frequency of the 20/30 loop to be output, in this order. In BASIC:

```
100 OUTPUT 719; "SHM3 OD"
110 ENTER 719; F2, F3
120 PRINT "PLL #2"; F2; " HZ"
130 PRINT "PLL #3"; F3; " HZ"
```

4. Diagnostic Tests and Results: Programming code SHM4 (key-strokes **[SHIFT] [M4]**; see Figure 3-9) causes a series of up to 32 diagnostic tests to be performed with the test results available from the front panel or as a string of 32 characters. These characters may be either 1 or 0 indicating a passed or failed test respectively. In Basic:

```
100 DIM Test ___ no$(32)[20]
110 OUTPUT 719; "SHM4"
120 FOR I=1 TO 32
130 READ Test ___ no$(I)
140 DATA "PROCESSOR TST", "ROM 1 CKSUM", "ROM 2 CKSUM", "ROM 3
    CKSUM", "ROM 4 C KSUM", "RAM 1 RD/WR", "RAM 2 RD/WR", "EEROM
    1 RD/WR", "EEROM 2 RD/WR"
150 DATA "MRK RAM RD/WR", "PIT (LED REG)", "PIT RESPONDS", "IO ADDR
    BUSS", "IO D ATA BUSS", "A-D CONVERTER", "LEVEL REF DAC", "MAN
    SWP DAC", "MARKER RAMP"
160 DATA "RESET DAC", "LEVEL SWP DAC", "BND CROSS DAC", "SWP
    WIDTH DAC", "SWP RANGE ATN", "V/GHz CIRCUIT", "V/GHz BND
    ATN", "BRK PNT 1 DAC", "BRK PNT 2 DAC"
170 DATA "ATN SLOPE DAC", "YO PRETUN DAC", "NOT USED", "A27
    INSTALLED"
180 NEXT I
190 DIM Dt$(32)
200 OUTPUT 719; "OD"
210 ENTER 719; Dt$
220 FOR I = 1 TO 32
230 IF Dt$(I) = "1" THEN
240 IMAGE 13A, 10X, "PASS"
250 PRINT USING 240: Test no$(I)
260 ELSE
270 IMAGE 13A, 10X, "FAIL"
280 PRINT USING 270: Test ___ no$(I)
290 END IF
300 NEXT I
310 END
```

Consult Section VIII, Service, for a detailed explanation of these diagnostic functions.

**OF(d)** Output Fault, outputs a decimal value that can be decoded to determine which fault conditions have occurred. These fault conditions are automatically accumulated by the HP 8341A, and are only cleared by an Instrument Preset or when the fault has been output following an OF command. The outputted decimal number is interpreted at the bit level, where the bits are defined as follows:

Bit 0: Not used.  
 Bit 1: Not used.  
 Bit 2: N1 oscillator unlocked.  
 Bit 3: N2 oscillator unlocked.  
 Bit 4: YIG oscillator unlocked.  
 Bit 5: HET oscillator unlocked.  
 Bit 6: M/N oscillator unlocked.  
 Bit 7: REF oscillator unlocked.  
 Bit 8: Not used.  
 Bit 9: Not used.  
 Bit 10: LVC - pretest of level control board failed.  
 Bit 11: PEAK - peaking algorithm failed.  
 Bit 12: ADC - ADC time out.  
 Bit 13: KICK - YO or SYTM kick pulse time out.  
 Bit 14: CAL - calibration data checksum incorrect.  
 Bit 15: Not used.

If any of these fault conditions are encountered, consult Section VIII (Service) for further instructions. A BASIC example:

```
100 OUTPUT 719: "OF"
110 ENTER 719: F
120   FOR N = 0 TO 15
130   PRINT "BIT ";N:" = ";BIT(F,N)
140   NEXT N
```

Line 130 determines each bit of arbitrary variable F in the BIT(F,N) statement.

**OI(19a)** Output Identification, outputs the revision date of the firmware presently loaded into the HP 8341A as:

08340AREV day month year  
 (2 numbers for the day, 3 letters for the month, and 2 numbers for the year)

A BASIC example:

```
10   DIM AS[19]
.
.
.
100 OUTPUT 719: "OI"
110 ENTER 719: AS
120 PRINT "FIRMWARE REVISION": AS
```

**OK(d)** Output last locKed frequency, indicates the last phase locked frequency of the HP 8341A, in Hz. A BASIC example:

```
100 OUTPUT 719: "CWEK"
110 PAUSE
120 OUTPUT 719: "OK"
130 ENTER 719: F
140 PRINT "LAST FREQUENCY": F: " HZ"
```

In line 100, the rotary [**Knob**] is enabled (EK) and used to adjust the CW frequency. After completing the frequency adjustment, press [**Continue**] on the computer and the last phase lock frequency (the current CW frequency in this example) is read and printed.

**OL**(123b) Output Learn data, is used in conjunction with IL (Input Learn data) to save and recall specific instrument operating configurations. OL/IL is similar to SAVE/RECALL, except: the function that was active prior to OL storage is once again active after an IL recall; and SAVE/RECALL is restricted to nine instrument configurations and uses the memory of the HP 8341A, while OL/IL uses the computer's memory and is restricted only by the size of that memory.

The learn data consists of 123 bytes of information. This information is heavily coded and densely packed for conciseness, so a byte-by-byte deciphering is not recommended (use OP to obtain information about a specific function or state). This is a typical BASIC program using OL and IL:

```
10 DIM A$(123)
.
.
.
100 OUTPUT 719; "... (programming codes) ... "
110 REM
120 REM STORE THIS INSTRUMENT STATE
130 OUTPUT 719; "OL"
140 ENTER 719 USING "#, 123A"; A$
150 REM
160 REM RETRIEVE THIS INSTRUMENT STATE
170 OUTPUT 719; "IL"&A$
```

Line 140 is a formatted I/O statement, where the # suppresses the end-of-line sequence (so valid data is not misinterpreted as EOL), and the 123A is an instruction to fill A\$ with 123 bytes of literal data. Line 170 concatenates the literal data in A\$ (which is an arbitrary variable) with the IL programming code. For additional I/O formatting information, consult the I/O Programming Manual for the specific computer being used.

**OM**(8b) Output Mode, outputs 8 bytes of information that completely describes the presently active functions of the HP 8341A:

Byte 1 records the last-pressed front panel key.

Byte 2 indicates the active function.

Byte 3 records the active and previously active markers.

Byte 4 indicates the marker status.

Byte 5 indicates trigger, sweep, and frequency modes.

Byte 6 indicates the status of various front panel functions.

Byte 7 indicates output power and leveling status.

Byte 8 indicates the status of the modulation and other functions.

A BASIC example:

```
10 DIM B(8)
```





```

100 OUTPUT 719; "OM"
110 ENTER 719 USING "#, B"; B(1), B(2), B(3), B(4), B(5), B(6), B(7), B(8)
120 FOR J = 1 TO 8
130 PRINT "BYTE "; J
140 PRINT "DECIMAL "; B(J)
150   FOR K = 0 TO 7
160     PRINT "BIT"; K; "="; BIT(B(J),K)
170   NEXT K
180 PRINT
190 NEXT J
    
```

Line 110 suppresses the normal end-of-line sequence by using the “#” image specifier (this must be done in case the bit pattern of the data coincidentally duplicates the bit pattern of the EOL, which would cause a false termination), and inputs the 8 bytes of data (image specifier “B” indicates binary data). Lines 120-190 prints the bytes’ decimal and bit values. This is how to interpret the byte data:

BYTE 1 indicates the last-pressed from panel key, and the decimal value of this byte corresponds to the keys as follows:

Decimal Value	Key	Decimal Value	Key
0-9	[0] - [9] numerical keys	82	[RECALL]
10	[.]	83	[ALT]
11	[-] minus key	84	not used
12	[- / BACK SPACE] used as the back space	85	[PULSE]
13	[▲]	86	[AM]
14	[▼]	87	[ENTRY OFF]
15	[MKR CF]	88-96	not used
16	[SHIFT] [MKR SWEEP]	97	[START FREQ]
17	[INSTR PRESET]	98	[STOP FREQ]
18-64	not used	99	[CF]
65	[CONT]	100	[Δ F]
66	[SINGLE]	101	[CW]
67	[MANUAL]	102	[POWER LEVEL]
68	[M1]	103	[SWEEP TIME]
69	[M2]	104	[SHIFT]
70	[M3]	105	[GHz / dB(m)]
71	[M4]	106	[MHz / sec]
72	[M5]	107	[KHz / msec]
73	[FREE RUN]	108	[Hz / AUTO]
74	[LINE]	109	[INT]
75	[EXT]	110	[XTAL]
76	[MKR SWEEP]	111	[METER]
77	[OFF]	112	[AMTD MKR]
78	[MKR Δ]	113	[PEAK]
79	not used	114	[PWR SWP]
80	[LOCAL]	115	[SLOPE]
81	[SAVE]	116	[RF]
		117-128	not used

Decimal Value	Key	Decimal Value	Key
(Note: Although all possible shift-key combinations are listed, some of these combinations have no effect on the HP 8341A.)		161	[SHIFT] [START FREQ]
		162	[SHIFT] [STOP FREQ]
		163	[SHIFT] [CF]
		164	[SHIFT] [ $\Delta$ F]
		165	[SHIFT] [CW]
		166	[SHIFT] [POWER LEVEL]
		167	[SHIFT] [SWEEP TIME]
		168	[SHIFT] [SHIFT]
		169	[SHIFT] [GHz / dB(m)]
129	[SHIFT] [CONT]	170	[SHIFT] [MHz / sec]
130	[SHIFT] [SINGLE]	171	[SHIFT] [KHz / msec]
131	[SHIFT] [MANUAL]	172	[SHIFT] [Hz / AUTO]
132	[SHIFT] [M1]	173	[SHIFT] [INT]
133	[SHIFT] [M2]	174	[SHIFT] [XTAL]
134	[SHIFT] [M3]	175	[SHIFT] [METER]
135	[SHIFT] [M4]	176	[SHIFT] [AMTD MKR]
136	[SHIFT] [M5]	177	[SHIFT] [PEAK]
137	[SHIFT] [FREE RUN]	178	[SHIFT] [PWR SWP]
138	[SHIFT] [LINE]	179	[SHIFT] [SLOPE]
139	[SHIFT] [EXT]		
140	not used	180	[SHIFT] [RF]
141	[SHIFT] [OFF]	181	[SHIFT] [0]
142	not used	182	[SHIFT] [1]
143	not used	183	[SHIFT] [2]
144	[SHIFT] [LOCAL]	184	[SHIFT] [3]
145	[SHIFT] [SAVE]	185	[SHIFT] [4]
146	[SHIFT] [RECALL]	186	[SHIFT] [5]
147	[SHIFT] [ALT]	187	[SHIFT] [6]
148	not used	188	[SHIFT] [7]
149	[SHIFT] [PULSE]	189	[SHIFT] [8]
150	[SHIFT] [AM]	190	[SHIFT] [9]
151	[SHIFT] [ENTRY OFF]	191	not used
152	[SHIFT] [  ]		
153	[SHIFT] [  ]		
154-160	not used		

BYTE 2 shows the presently active function. Decipher the decimal value of BYTE 2 as follows:

Dec. Value	Active Function	Dec. Value	Active Function
0	non-numerical function (either SAVE LOCK, CLEAR LOCK, or ENTRY OFF)	23	HP-IB address ([SHIFT] [LOCAL])
1	SAVE in register n	24	not used
2	RECALL from register n	25	ZOOM frequency function
3	ALTErnate with register n	26	MANUAL sweep
4	I/O read ([SHIFT] [kHz / msec])	27	Frequency offset ([SHIFT] [STOP FREQ] )
5	UNLK indicators ([SHIFT] [EXT])	28	frequency multiplier ([SHIFT] [START FREQ])
6	Power LVL STEP size	29	RF SLOPE
7	POWER LEVEL	30	not used
8	SWEEP TIME	31	not used
9	CW RESolution	32	PWR SWP
10	CW frequency	33	not used
11	CF center frequency	34	Power meter leveling ([METER])
12	$\Delta$ F delta frequency	35	Decoupled ATN/ALC ([SHIFT] [PWR SWP])
13	START frequency	36	Attenuator control ([SHIFT] [SLOPE])
14	STOP frequency	37	Bypassed ALC ([SHIFT] [METER])
15	Marker 1	38	not used
16	Marker 2	39	not used
17	Marker 3	40	I/O channel ([SHIFT] [GHz / dB(m)])
18	Marker 4	41	I/O subchannel ([SHIFT] [MHz / sec])
19	Marker 5	42	I/O write ([SHIFT] [kHz / msec])
20	not used	43	Sweep time limit (programming code TL)
21	FREQuency STEP size	44-245	not used
22	Calibration constants accessed	246	Fault diagnostic ([SHIFT] [MANUAL])
		247-256	not used

BYTE 3 shows the presently active and previously active markers. The marker information is coded in bit groups 0-2 (active marker), 3-5 (previously active marker), and 6-7 (not used); the decimal value of those bit groups is the marker number. For example:

```

BIT NUMBER  7  6  5  4  3  2  1  0
BIT PATTERN X  X  0  1  0  0  1  1
    
```

is decoded as "active marker is M3 (decimal value of bits 0-2 is 3), and previously active marker is M2 (decimal value of bits 3-5 is 2)."

BYTE 4 shows the on/off status of the markers and marker functions. If a bit is set True (=1) the marker or function is on, if the bit is False they are off. This is the bit code:

Bit	Marker or Function
0	MKR SWP
1	M1
2	M2
3	M3
4	M4
5	M5
6	not used (always = 0)
7	MKR $\Delta$

BYTE 5 shows the status of the TRIGGER, SWEEP, and FREQUENCY modes. Like byte 3, the mode information is organized by bit groups, and is decoded by using the decimal value of those groups. This is the bit group organization:

Bits	Mode Information
0-1	TRIGGER MODE 0 = FREE RUN 1 = LINE = EXT
2-4	SWEEP MODE 0 = CONT 1 = SINGLE 2 = MANUAL with Hz resolution (code SM) 3 = not used 4 = MANUAL with STEP resolution (code SN)
5-7	FREQUENCY MODE 0 = START/STOP 1 = CF/ $\Delta$ F 2 = CW, with sweep on 3 = CW, with sweep off

BYTE 6 shows the status of miscellaneous modes and functions, which are ON if the appropriate bit is True (=1), or are OFF if the bit is False.

Bit	Mode or Function
0	AMTD MKR
1	not used (always = 1)
2	not used (always = 1)
3	not used (always = 0)
4	Entry enabled and rotary [ <b>KNOB</b> ] on
5	SAVE lock enabled
6	ALT mode
7	Keyboard [ <b>SHIFT</b> ] on

BYTE 7 shows the status of the power and leveling functions. The decimal value of bit group 0-1 indicates the leveling modes, while the remaining bits indicate whether the function is on (=1) or off (=0).

Bits	Mode or Function
0-1	ALC leveling modes 0 = INT 1 = XTAL 2 = METER
2	not used (always = 0)
3	PWR SWP
4	SLOPE
5	RF
6	not used
7	not used

BYTE 8 shows the remaining front panel modes and functions, with the True bits (=1) indicating ON, and the False bits (=0) indicating OFF.

Bits	Mode or Function
0	not used (always = 0)
1	not used (always = 0)
2	not used (always = 1)
3	PULSE
4	not used
5	AM
6	PEAK
7	Penlift enabled ( [SHIFT] [LINE] )

**OP(d)** Output interrogated Parameter, instructs the HP 8341A to output the numerical value of any specified function, even if that function is not presently active. The code for any function that has a numerical value associated with it is appended to OP; for example, OPCF for the center frequency (but not CFOP), or OPST for the sweep time (but not STOP). The numerical value is always output in the fundamental units of Hz, dB(m), or seconds. A BASIC example:

```
100 OUTPUT 719; "OPCF"
110 ENTER 719; N
120 PRINT "CENTER FREQUENCY = "; N; " HZ"
```

In this example, N is an arbitrary variable.

**OR(d)** Output power level, causes the HP 8341A to output the present power level of the instrument. PLOA, OPPL and OR can be used to output power level, but there is a significant difference in the implementation of these codes by the HP 8341A: OR causes the power to be measured by the internal ADC, while PLOA and OPPL reflect the user-requested power that is shown in the ENTRY DISPLAY.

PLOA or OPPL accurately indicate the power output only when the HP 8341A is internally leveled and is not being amplitude modulated (AM) by a modulation signal containing a dc component. Under these conditions the values of PLOA, OPPL, and OR will all agree to within the tolerances of the measuring circuits ( $\pm 0.1$  dB).

OR can always be used to measure power output, and must be used whenever any of these conditions exist: 1) The HP 8341A is unlevelled for any reason; 2) the instrument is being amplitude modulated by a modulation signal having a dc component; 3) the HP 8341A is being externally leveled.

A BASIC example:

```

100 OUTPUT 719; "OR"
110 ENTER 719; P
120 PRINT "POWER LEVEL = "; P; "DBM"
    
```

**OS(2b)** Output Status bytes, is used to read the two 8-bit status bytes from the HP 8341A. The first status byte concerns the cause of an SRQ (Service Request), while the second status byte concerns failures and faults, as follows:

STATUS BYTE (#1)								
BIT #	7	6	5	4	3	2	1	0
DECIMAL VALUE	128	64	32	16	8	4	2	1
FUNCTION	SRQ on New frequencies or Sweep Time in Effect	REQUEST SERVICE (RQS)	SRQ on HP-IB Syntax Error	SRQ on End of Sweep	SRQ on RF Settled	SRQ on Changed in Extended Status Byte	SRQ on Numeric Entry Completed (HP-IB or Front Panel)	SRQ on Any Front Panel Key Pressed
EXTENDED STATUS BYTE (#2)								
BIT #	7	6	5	4	3	2	1	0
DECIMAL VALUE	128	64	32	16	8	4	2	1
FUNCTION	Fault Indicator On	RF Unleveled	Power Failure	RF Unlocked	External Freq. Ref. Selected	Oven Cold	Over Modulation	Self Test Failed

Status Byte 1

Bit 0: SRQ caused by a key closure on the front panel of the HP 8341A (use the OM code to determine the front panel status).

Bit 1: SRQ caused by the completion of a numeric entry (use the OA code to determine the value of the numerical entry).

Bit 2: SRQ caused by a change in the extended status byte (status byte 2) affected by the RE-coded mask (see the RE code for an explanation of this masking).

Bit 3: SRQ caused by the completion of phase locking and the settling of the RF source (use the OK code to determine the last lock frequency).

Bit 4: SRQ on end-of-sweep or mid-sweep update in NA (network analyzer code) mode.

Bit 5: SRQ caused by HP-IB syntax error.

Bit 6: SERVICE REQUEST; by IEEE-488 convention, the instrument needs service from the controller when this bit is set true.

Bit 7: SRQ caused by a change in the coupled parameters (start frequency, center frequency, and sweep time). Use the OC code to determine the new values of the coupled parameters.

#### Status Byte 2 (Extended Status Byte)

Bit 0: Self test failed at power on or at Instrument Preset. This bit remains latched until this status byte has been read, or until cleared by the CS or CLEAR 719 commands.

Bit 1: Excessive amplitude modulation input.

Bit 2: Oven for the reference crystal oscillator is not at operating temperature.

Bit 3: External reference frequency was selected by the rear-panel FREQUENCY STANDARD switch.

Bit 4: RF is unlocked (UNLK appears in the ENTRY DISPLAY). Use OF to determine the source of the unlocked output. This bit remains latched until this status byte has been read, or until cleared by the CS or CLEAR 719 commands.

Bit 5: AC line power interruption has occurred since the last Instrument Preset. This bit also remains latched until read or cleared.

Bit 6: RF is unlevelled (use OR to determine present power level). This bit also remains latched until read or cleared.

Bit 7: FAULT annunciator is on (seen in the ENTRY DISPLAY of the HP 8341A). Use OF to determine the cause of the fault.

A BASIC example:

```

10  REM CLEAR (RESET TO ZERO) BOTH STATUS BYTES
20  OUTPUT 719; "CS"
.
.
.
100 OUTPUT 719; "OS"
110 ENTER 719 USING "#,B": S1, S2
120   S=S1
130   FOR K = 1 TO 2
140     PRINT "STATUS BYTE ": K
150     FOR N = 0 TO 7
160       PRINT "BIT ";N:" = ";BIT(S,N)
170     NEXT N
180   S=S2
190 NEXT K

```

Line 110 is a formatted I/O statement, where # suppresses the end-of-line sequence (to avoid misinterpreting valid data as an EOL sequence), and B indicates that each of the following variables (arbitrary variables S1 and S2) should be filled with one byte of information. Line 160 determines each bit of the status bytes, status byte 1 first (S = S1, N = 0 to 7) then status byte 2 (S = S2, N = 0 to 7).

Programming codes RM and RE explain how the status bytes can be masked.

**RBb** Remote knob, allows the rotary knob of other instruments (computers, network analyzers) to control the active function of the HP 8341A. The knob is sometimes called an RPG (rotary pulse generator) or cursor wheel in the manuals of other instruments. Here is a demonstration program for the HP 9826/9836 series of computers:

```

10 REM PRINT TO THE CRT, NOT THE LINE PRINTER
20 PRINTER IS 1

30 OUTPUT 719; "IP CW1GZ"
40 ON KNOB .075 GOSUB 60
50 GOTO 50

60 Count = KNOBX
70 PRINT "KNOB COUNT = "; Count
80 OUTPUT 719; "RB"&CHR$(Count)
90 RETURN

100 END

```

Line 30 establishes CW as the active function, with an initial value of 1.0 GHz. ON KNOB in line 40 instructs the computer to detect any rotation of the knob. The HP 9826/9836 knob generates 120 pulses per revolution; when the first pulse is detected, line 40 starts a sampling-time clock (75 milliseconds in this example) and branches to the subroutine located at line 60.

KNOBX in line 60 counts the pulses that occur in the sampling-time interval (the sampling time range is 0.01-2.55 seconds, but the sampling time must be short enough to keep the pulse count in the range of -127 to +128), and assigns the value of that count to arbitrary variable Count. Line 70 displays the pulse counts on the computer's CRT (pulse counts of  $\pm 1$ -30 are typical for this sampling time). Line 80 sends the pulse count information to the HP 8341A, where it affects the active function (CW in this example).

In line 80, the pulse count is converted from decimal to binary by the CHR\$ function, and concatenated to the RB code. One byte of numerical data can accompany RB, so the decimal value of Count has an allowable range of -127 to +128. The sampling time is arbitrary; 75 milliseconds was selected for this example because the resultant response of the computer's knob approximates the response from the HP 8341A's knob (the exact effects of the sampling time must be ascertained by experiment).

**REb, RMb** Request mask Extended, and Request Mask, allow masking of the extended status byte (status byte 2) and the service request status byte (status byte 1), respectively. Masking is usually done for interrupt programming, where non-critical bits of the status bytes are masked to prevent them from initiating an unimportant interrupt.

To mask a status byte, the HP 8341A must receive the RE and/or RM code that includes the numerical value of the enabled bits. The numerical value of the bits, in decimal, is:

BIT	7	6	5	4	3	2	1	0
DECIMAL	128	64	32	16	8	4	2	1



For example, to enable bit 2 on status byte 1 while occluding the six other bits, the programming code is `"RM"&CHRS(4)`, where the decimal value of bit 2 is converted to binary by the `CHRS` function and concatenated to the `RM` code.

Masked interrupt programming requires the identification and enabling of the computer's interrupt register, and the transmission of the `RM/RE` codes to the HP 8341A. Here is a typical BASIC example:

```

100 OUTPUT 719; "CS"
110 OUTPUT 719; "RM"&CHRS(4)
120 OUTPUT 719; "RE"&CHRS(64)
130 ENABLE INTR 7; 8
140 ON INTR 7 GOTO 500
150 OUTPUT 719; "PLEK"
.
.
.
500 PRINT "WARNING: RF UNLEVELED"

```

Line 110 enables bit 2 (only) of status byte 1, which is the bit that causes an `SRQ` to be sent when any of the bits in status byte 2 change. Line 120 enables bit 6 (only) of status byte 2, which detects an unlevelled `RF` output. Thus, an unlevelled `RF` is the only condition that will cause the HP 8341A to send an `SRQ`.

Line 130 enables the computer's interrupt register that is associated with I/O port 7, and instructs the computer to monitor bit 3 (decimal 8) for a true condition. Bit 3, in this example, is the `SRQ RECEIVED` bit, but the actual bit depends upon the particular computer being used (e.g., bit 2 for the HP 9826A, bit 3 for the HP-85A). Line 140 directs the program in the event of a true bit 3, which could occur if the power level is set too high (line 150 allows operator adjustment of the power level via the rotary `[KNOB]`).

Once set, several status byte bits remain latched until cleared by `CS` or `CLEAR` (or until after the status bytes are read a second time). The `OS` explanation describes all status byte bits.

**RS** Reset Sweep, causes the HP 8341A to retrace to the start frequency. If a sweep is in progress when an `RS` code is received, the sweep will abruptly terminate and retrace. In BASIC:

```

100 OUTPUT 719; "RS"

```

**SF**dt Step Frequency size, sets the size of the frequency increment that can be stepped by `UP` or `DN` (equivalent to the up/down front-panel `[STEP]` keys). The `SF` code is equivalent to the `SHCF` code, and both are equivalent to the `[SHIFT] [CF]` keystroke operation (as described in Figure 3-7).

The `SF` step size can be as small as 1 Hz, as large as 10 GHz, or it can be coupled to the  $\Delta F$  frequency span with the `AU` (auto) code (the coupling is explained in Figure 3-7). A BASIC example:

```

100 OUTPUT 719; "SF 1 MZ"
110 OUTPUT 719; "CW 400 MZ"
120   FOR N = 1 TO 200
130     OUTPUT 719; "UP"
140     NEXT N
150 GOTO 110

```

This program sets the step size to 1 MHz, establishes a starting CW frequency of 400 MHz, then performs a 400-600 MHz discrete sweep.

**SG** Single sweep, is identical to the S2 code, and both are equivalent to the front-panel **[SINGLE]** key which is described in Figure 3-11. SG causes the HP 8341A to perform single sweeps, and is used in conjunction with the TRIGGER codes (T1, T2, and T3). If trigger code T1 ( **[FREE RUN]** ) is in effect, the SG code (or the TS code) is output every time a single sweep is needed. If SG is output in the middle of a sweep, the sweep will abruptly terminate and retrace. A BASIC example:

```
100 OUTPUT 719: "IP SG T1"
110 PRINT "PRESS [CONTINUE] TO START THE SWEEP"
120 PAUSE
130 OUTPUT 719: "SG"
140 GOTO 120
```

**SMdt** Sweep Manual, is identical to the S3 code, and both are equivalent to the front-panel **[MANUAL]** key which is described in Figure 3-11. SM is used by first establishing the start and stop sweep frequencies, then outputting SM to activate manual sweep mode. A BASIC example:

```
100 OUTPUT 719: "IP FA5GZ SF1MZ FB15GZ EK SM"
```

This example sets a 5 GHz start frequency, a 1 MHz frequency step size, and a 15 GHz stop frequency. The last two codes in line 100 enable the rotary **[KNOB]** and activate manual sweep mode. In addition to **[KNOB]** control of the sweep, UP and DN can be used and would have a 1 MHz step size.

There are two significant differences between manual sweep and a stepped CW sweep:

1. The sweep voltage ramp (see Figures 3-13 and 3-18, SWEEP OUTPUT) is 0-10 volts for both modes; however, in CW mode 0 volts always corresponds to 10 MHz and 10 volts always corresponds to 20 GHz, while in manual sweep mode 0 volts corresponds to the start frequency and 10 volts corresponds to the stop frequency. In both cases the sweep voltage at intermediate frequencies is a linear interpolation of the frequency span (i.e., a frequency half-way between the start/stop limits would have a corresponding sweep voltage of 5 volts).
2. The bandcrossing points in CW mode always occur at precisely 2.4 GHz, 7.0 GHz, and 13.5 GHz. In manual sweep mode the bandcrossing points have 200 MHz of flexibility and could, for example, accomplish a 6.95-13.55 GHz sweep in a single band instead of the three bands required in stepped CW. The HP 8341A automatically adjusts the manual sweep bandcrossing point for optimum results.

**SNdt** Sweep Number, is used to establish the number of steps for a stepped sweep. The minimum number of steps is 10, while the maximum number is 1000; the frequency sweep span is divided by this SN number to determine the step increment. SN initializes the stepped sweep conditions, but the IF code or the HP-IB statement TRIGGER must be used in conjunction with SN to actually initiate each frequency step. A BASIC example:

```
100 OUTPUT 719: "FA8GZ FB12GZ SN400"
110 FOR N = 1 TO 400
120 OUTPUT 719: "IF"
130 NEXT N
```

This program causes a sweep that starts at 8 GHz and makes 400 steps (10 MHz increments) to the 12 GHz stop frequency. The IF code in line 120 initiates each of the 400 increments; alternatively, line 120 could be:

```
120 TRIGGER 719
```

**SP**dt Set Power step size, is identical to the SHPL code, and both are equivalent to the **[SHIFT] [POWER LEVEL]** key which is described in Figure 3-7.

The power step size can be as small as 0.05 dB, or as large as 50.00 dB. Once set, the power level can be incremented by the UP code or decremented by the DN code. Here is a BASIC example of a 120 dB, discrete power sweep at a 12 GHz CW frequency:

```
100 OUTPUT 719; "CW 12 GZ"
110 OUTPUT 719; "SP 0.05 DB"
120 OUTPUT 719; "PL -20 DB"
130   FOR N = 1 TO 600
140     OUTPUT 719; "UP"
150   NEXT N
160 GOTO 120
```

The power sweep starts at -20 dBm, and increments in 600 discrete, 0.05 dB steps to an end value of 10 dBm.

**SW**m SWap network analyzer channels, is used in conjunction with alternate mode and causes the foreground and background instrument states to be transposed.

Foreground refers to the present operating configuration of the HP 8341A as seen on the front panel displays and indicators, while background is the configuration that is derived from one of the SAVE/RECALL registers 1-9. When the HP 8341A is alternating between the foreground and background configurations only the foreground configuration shows on the front panel displays and indicators, even when the instrument is operating under background conditions. Hence, only the foreground configuration can be changed. SW transposes foreground and background, causing the background to show on the front panel where changes can be made.

Define the foreground configuration as state "A," and the background configuration as state "B" at the moment that alternating operation begins: At any time thereafter, SW0 causes state "A" to be the front panel state, while SW1 causes state "B" to be the front panel state.

SW does not change any of the values in the SAVE/RECALL register from which the background was derived, even if the background values are changed (when alternate mode is initiated the values in the RECALL register are transferred into the background register; after this transfer, only the background register is involved in alternating operations).

**T1b(b)** Test HP-IB Interface, verifies correct data transmission along the HP-IB interface. The procedure involves sending a data byte to the HP 8341A, then having the HP 8341A return the same byte to the computer where the out-going and incoming data is compared. In BASIC:

```

100 FOR N = 0 TO 255
110 OUTPUT 719; "TI"&CHR$(N)
120 ENTER 719 USING "#,B"; A
130 IF A <> N THEN GOSUB 500
140 NEXT N
150 PRINT "TEST COMPLETED"
.
.
.
500 PRINT "TEST FAILED"
510 PRINT "TRANSMITTED";N;"RETURNED";A
520 PRINT
530 RETURN

```

The decimal numbers 0 through 255 cover all possible bit patterns for an 8-bit byte (thus thoroughly exercising all 8 HP-IB data lines), and these numbers are concatenated onto the TI code in line 110. The image items in line 120 specify that EOL should be suppressed (#), and that variable A (an arbitrary variable) should be filled with one byte of binary data (B). In line 130, a returned value that is less than or greater than (i.e., not equal to) the transmitted value signifies an HP-IB test failure.

**TLdt** Time Limit, constrains the minimum allowable sweep time. The full sweep-time range of the HP 8341A is 10 milliseconds minimum to 200 seconds maximum (although the minimum sweep time is frequency-span dependent, and cannot exceed a sweep rate of 600 MHz / 1 millisecond); TL sets a limit on the minimum sweep time, with that limit ranging from 10 milliseconds to 40 seconds. For example,

```
100 OUTPUT 719; "TL15SC"
```

changes the permissible sweep-time range to 15-200 seconds. STAU is normally used to obtain the fastest possible sweep time for a given frequency span; however, AU will not override a TL restriction.

**TS** Take Sweep, initiates a single, non-interruptible sweep. All HP-IB commands are deferred until that sweep has been completed. If TS is output while a sweep is in progress, that sweep will abruptly stop, retrace, and begin a new, non-interruptible sweep. The HP 8341A will resume the previous sweep operations at the completion of the TS initiated sweep. A BASIC example:

```

100 OUTPUT 719; "IP SG"
110 PRINT "PRESS [CONTINUE] TO START THE SWEEP"
120 PAUSE
130 OUTPUT 719; "TS"
140 GOTO 120

```

This completes the listing of unique HP-IB programming codes.

### System Timing

It is sometimes necessary to determine the time required for a sequence of programming codes to be implemented by the HP 8341A. This can be accomplished by the computer's set-time and read-time commands:

```

100  set-time command (computer specific)
.
.
.
200  OUTPUT 719: "... (programming codes) ..."
.
.
.
300  C = read-time command (computer specific)
310  PRINT "TIME REQUIRED"; C

```

For example, the clock commands for the HP 9826/9836 computers are:

```

100  SET TIME 0
.
.
.
300  Clock = TIMEDATE MOD 86400
310  PRINT "TIME REQUIRED"; Clock

```

For the HP-80 series computers the commands are:

```

100  SETTIME 0,0
.
.
.
300  C = TIME
310  PRINT "TIME REQUIRED"; C

```

Other computers use similar commands.

### HP-IB Programming Techniques for Special Applications

Although the preceding programming codes are sufficient for most applications, it is possible to program the HP 8341A at a fundamental level by directly manipulating signals on the HP-IB lines. The following material presents an introductory explanation of these specialized procedures, first by briefly explaining the HP-IB signal lines, followed by the computer codes necessary for direct control of the HP-IB lines.

#### HP-IB Pin-Out Description

Figure 3-25 shows a detailed view of the HP-IB connector, with a pin-out description. Notice that HP-IB has 16 dynamic, TTL-level signal lines which can be categorized into three groups: data lines, handshake lines, and system control lines. The signal level on these lines is either TTL low (a "True" condition), TTL high (a "False" condition), or floating (electrically disconnected).

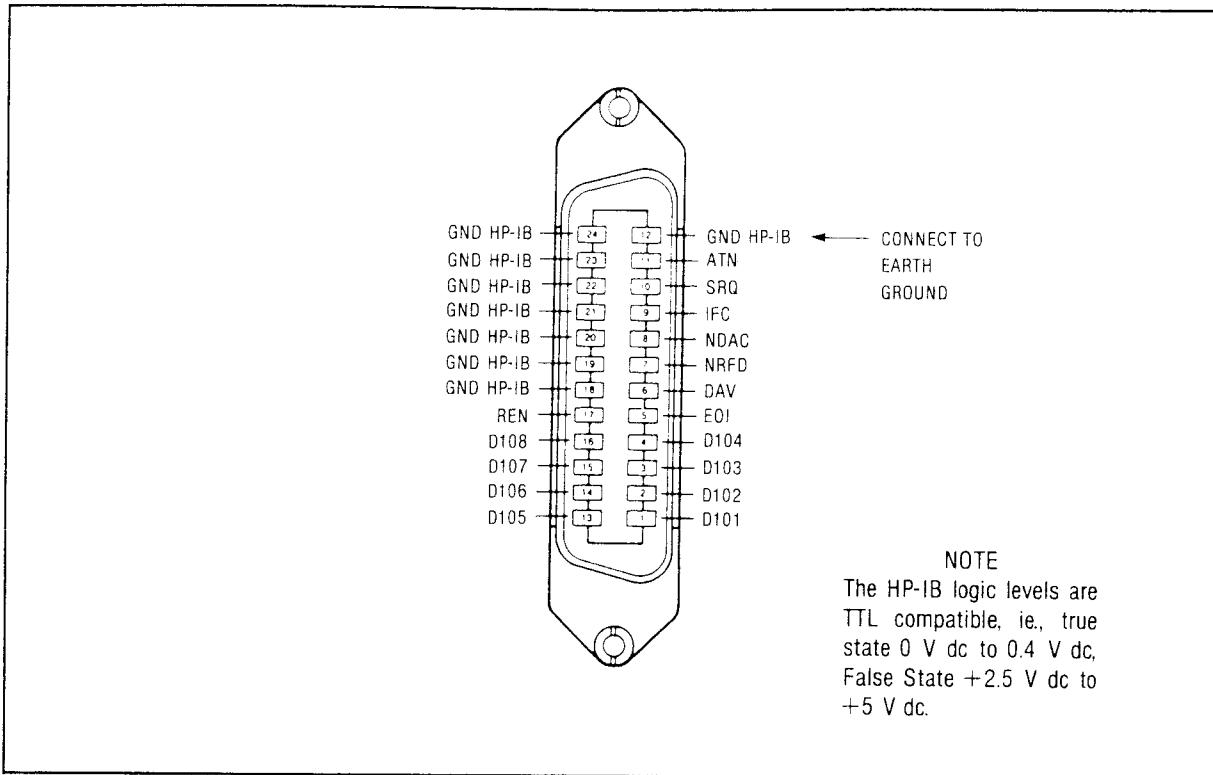

Figure 3-25. HP-IB Pin-Out

**Data lines, DIO1-DIO8.** These are the eight Data Input/Output lines. Data is transceived on the eight HP-IB data lines as a series of eight-bit bytes, with DIO1 being the least significant bit (LSB) and DIO8 being the most significant bit (MSB). The meaning of each byte is arbitrary, being different for each type of instrument. The rate of data transfer is controlled by the handshake sequence.

**Handshake lines, DAV, NRFD, NDAC.** These three lines control the data transfer process.

**DAV.** Data Valid, line is high (False - data not valid) or low (True - data valid) to indicate the validity of the signals on the DIO lines.

**NRFD.** Not Ready for Data, line indicates whether the instruments receiving data are prepared to accept that data; NRFD is either low (True - the instruments are not ready for data) or high (False - the instruments are ready for data).

**NDAC.** Not Data Accepted, line indicates whether the data-receiving instruments have accepted the transmitted data. The NDAC is either high (False - the data has been accepted) or low (True -the data has not been accepted).

Figure 3-26 illustrates a representative handshake timing sequence.

**System control lines, ATN, IFC, SRQ, REN, EOI.** The remaining five lines coordinate communications between the HP-IB LISTENERS, TALKERS, and CONTROLLERS. The system control lines are used as follows:

**ATN.** Attention, signals Command Mode when low (True), or Data Mode when high (False). All devices must monitor ATN at all times and respond to it within 200 nanoseconds. In Command Mode, the controller is the only talker in the network, while all other devices are listening for instructions.

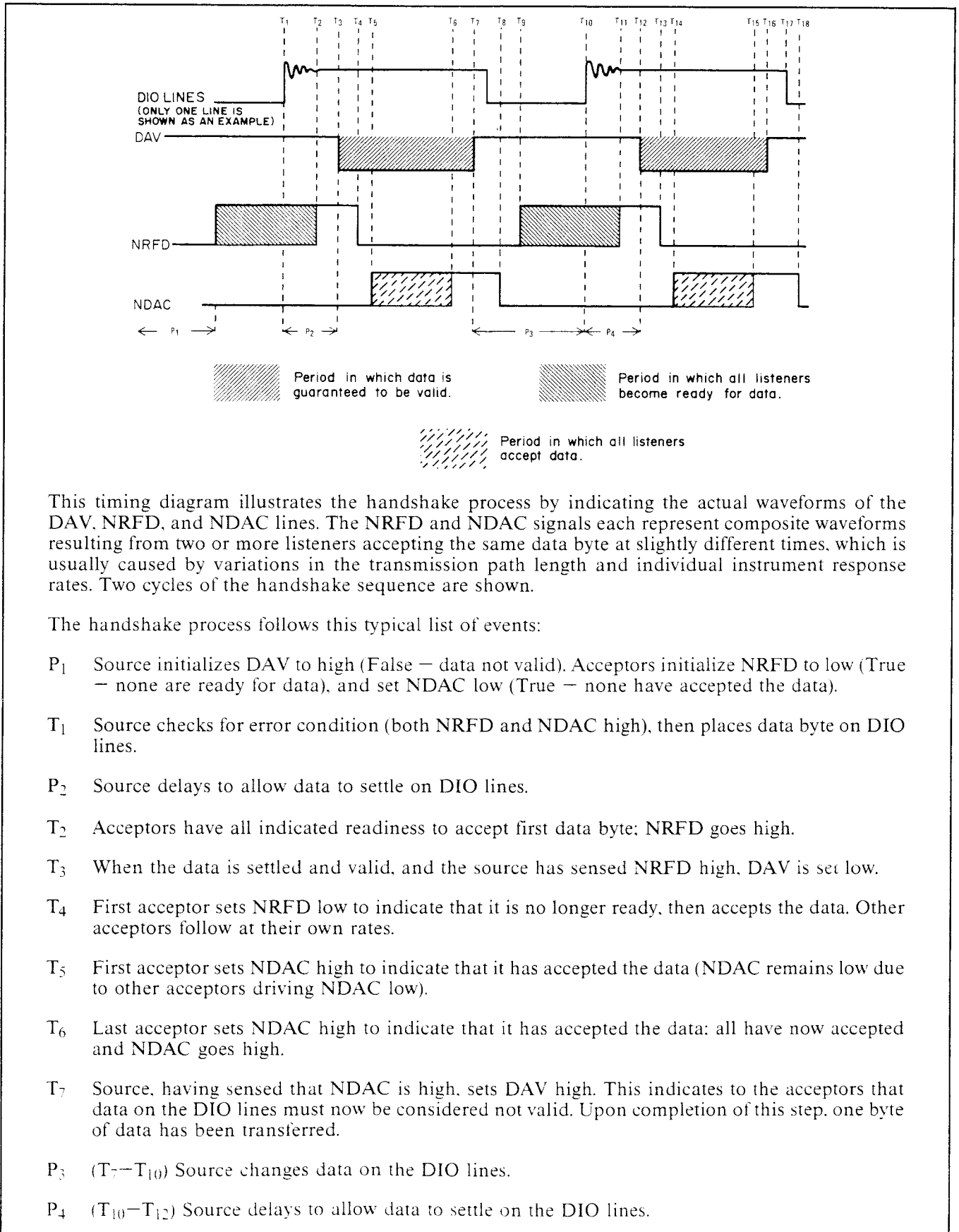

Figure 3-26. HP-IB Handshake Timing (1 of 2)

- T<sub>8</sub> Acceptors, upon sensing DAV high, set NDAC low in preparation for the next cycle. NDAC goes low as the first acceptor sets it low.
- T<sub>9</sub> First acceptor indicates that it is ready for the next data byte by setting NRFD high (NRFD remains low due to other acceptors driving it low).
- T<sub>11</sub> Last acceptor indicates that it is ready for the next data byte by setting NRFD high; NRFD signal line goes high.
- T<sub>12</sub> Source, upon sensing NRFD high, sets DAV low to indicate that data on the DIO lines is settled and is valid.
- T<sub>13</sub> First acceptor sets NRFD low to indicate that it is no longer ready, then accepts the data.
- T<sub>14</sub> First acceptor sets NDAC high to indicate that it has accepted the data.
- T<sub>15</sub> Last acceptor sets NDAC high to indicate that it has accepted the data (as at T<sub>6</sub>).
- T<sub>16</sub> Source, having sensed that NDAC is high, sets DAV high (as at T<sub>7</sub>).
- T<sub>17</sub> Source removes data byte from the DIO signal lines after setting DAV high.
- T<sub>18</sub> Acceptors, upon sensing DAV high, set NDAC low in preparation for the next cycle. All three handshake lines return to their initialized states (as at T<sub>1</sub> and T<sub>2</sub>).

*Figure 3-26. HP-IB Handshake Timing (2 of 2)*

When a high (False) ATN signifies Data Mode, data may be transferred along the DIO lines. The meaning of each data byte is device dependent, and selected by the instrument designer.

**IFC**, Interface Clear, when low (True) abruptly terminates all HP-IB communications activity: All talkers and listeners are "unaddressed," and along with the controllers go to an inactive HP-IB state (the instruments' local functions are not impaired). All devices must monitor IFC at all times and respond to it within 100  $\mu$ sec.

**SRQ**, Service Request, line is set low (True) by any instrument that needs service from the controller. An SRQ could result, for example, when an instrument is ready to transmit data upon the completion of a measurement, or from an error condition. When the controller detects an SRQ it performs a serial poll of all devices to determine which requested service, and why (polling is explained in the System Commands). The controller can mask the SRQ to prevent any inconvenient interruptions (as explained in the RE/RM programming codes). The HP 8341A lights a red SRQ annunciator in the ENTRY DISPLAY when it initiates an SRQ.

**REN**, Remote Enable, when low (True) enables HP-IB instruments to respond to commands from the controller or other talkers, when high (False) all devices return to local operation. The HP 8341A lights an amber REMOTE annunciator in the ENTRY DISPLAY when REN is true, and disables front panel control of the instrument (with three exceptions: the POWER switch can only be controlled locally, the [LOCAL] key re-enables front panel control unless locked-out by the controller, and the rotary [KNOB] can be re-enabled by an EK command from the controller). All devices must constantly monitor REN and respond to it within 100  $\mu$ sec.



**EOI**, End or Identify, is used in conjunction with ATN: When ATN is high (False) EOI goes low (True) to indicate the end of a data transmission sequence; when ATN is low (True) and EOI is low (True) a parallel poll of the HP-IB instruments is performed (the HP 8341A does not respond to parallel polling).

Typically, HP-IB data messages are sent as ASCII characters and are terminated with an ASCII "LF" (line feed, decimal 10). However, when blocks of binary information are being sent LF cannot safely be used as a terminator because the LF bit pattern could unintentionally occur in the middle of a data sequence. To prevent a false termination, the EOI line is used to signify the true end of a data sequence (alternatively, a byte-counting method that explicitly defines the number of expected data bytes can be used).

### The Twelve HP-IB Messages

The HP-IB control, handshake, and data lines interact to transfer information between interconnected instruments. This information transfer process can be organized into 12 distinct categories which are, by convention, referred to as bus messages. These messages will be explained using the following HP-IB mnemonics:

- ATN Attention HP-IB line TRUE, indicating Command operating mode.
- $\overline{\text{ATN}}$  Attention line FALSE, indicating Data transfer mode.
- CA Controller active state.
- CR Carriage Return, ASCII decimal 13.
- data One or more ASCII data bytes (the HP 8341A accepts lower-case ASCII characters, which it automatically upshifts).
- DCL Device Clear, returns all instruments (addressed or not addressed) to an instrument-defined state; DCL is accomplished by ASCII "DC4" (decimal 20).
- GET Group Execute Trigger, initiates a simultaneous instrument-defined response from all instruments; accomplished by ASCII "BS" (decimal 8).
- GTL Go To Local, returns instruments to local (front panel) control; accomplished by ASCII "SOH" (decimal 1).
- LA Listener active state.
- LAD Listen Address of a specific Device (see LAG).
- LAG Listen Address Group (listen addresses of specified instruments). An HP-IB instrument may have any unique address in the range 00-30 (decimal). The distinction between a listen address and a talk address is made in bits 5 and 6: using address 19 as an example:

BIT	7	6	5	4	3	2	1	0
TALK	X	1	0	1	0	0	1	1
LISTEN	X	0	1	1	0	0	1	1

The corresponding ASCII codes for the available HP-IB addresses are listed in Table 3-3.

- LF Line Feed, ASCII decimal 10.
- LLO Local Lockout, disables the instruments' [LOCAL]-reset key; LLO is accomplished by ASCII "DC1" (decimal 17).
- MLA My Listen Address (listen address of the controller).
- MTA My Talk Address (talk address of the controller).
- PPC Parallel Poll Configure (not used by the HP 8341A).
- PPU Parallel Poll Unconfigure (not used by the HP 8341A).
- SC System controller.
- SCG Secondary command group (also abbreviated SEC).
- SDC Selected Device Clear, causes addressed instruments to clear to an instrument-defined state; accomplished by ASCII "EOT" (decimal 4).
- SPD Serial Poll Disable, accomplished by ASCII "EM" (decimal 25).
- SPE Serial Poll Enable, accomplished by ASCII "CAN" (decimal 24). A serial polled instrument responds with a byte of information, with each bit corresponding to a specific instrument function.
- TA Talker active state.
- TAD Talk Address of a specified Device (see LAG for related information).
- TCT Take Control, transfers active controller responsibility to another instrument; accomplished by ASCII "HT" (decimal 9).
- UNL Unlisten, clears bus of all listeners in preparation for assigning new listeners; accomplished by ASCII "?" (decimal 63).
- UNT Untalk, unaddresses the current talker so that no talker remains on the bus; accomplished by ASCII "\_" (underscore, decimal 95).

These are the 12 bus messages (refer also to the HP-IB Command Statements that have the same names as these messages):

**DATA** represents the actual transfer of numerical information between instruments. The previous BASIC examples used OUTPUT and ENTER for data messages; the HP-IB bus sequence for a typical OUTPUT statement is:

ATN MTA UNL LAG  $\overline{\text{ATN}}$  (ASCII data) CR LF

The HP-IB sequence for a typical ENTER statement:

ATN UNL MLA TAG  $\overline{\text{ATN}}$  (ASCII data) CR LF

- TRIGGER** causes the listening instruments to perform an instrument-defined function, such as starting a sweep. A typical HP-IB sequence:
- ATN UNL LAG GET (REN line must be True before executing GET)
- CLEAR** causes the listening instruments to establish an instrument-specific predefined state. The HP-IB sequence:
- ATN DCL (for all bus instruments)
- ATN UNL LAD SDC (for an addressed instrument)
- REMOTE** causes listening instruments to switch from local (front panel) control to remote program control. The HP-IB sequence:
- REN ATN UNL LAG
- LOCAL** clears the REMOTE message and causes the listening instruments to return to local control. The HP-IB sequence:
- ATN UNL LAG REN GTL
- LOCAL LOCKOUT** prevents an instrument over-ride of remote control. The front panel [LOCAL] key is inoperative, and only the controller (or a hard reset by the POWER switch) can restore local control. The sequence:
- REN ATN LLO
- CLEAR LOCKOUT/LOCAL** causes all instruments on the bus to be removed from local lockout and to return to local control. The HP-IB sequence:
- $\overline{\text{REN}}$
- REQUIRE SERVICE** (SRQ) can be sent by an instrument at any time to signify that attention is required from the controller. The HP-IB sequence:
- SRQ
- The SRQ line is held true until the instrument no longer needs service, or until a poll is conducted to determine the nature of the SRQ.
- STATUS BYTE** is an 8-bit byte of information from an addressed instrument, with each bit signifying the status of a specific instrument function. The HP-IB sequence:
- ATN UNL LAD SPE  $\overline{\text{ATN}}$  (data byte) CR LF ATN SPD
- STATUS BIT** is a parallel poll of the bus instruments. The HP 8341A does not respond to parallel polling.
- PASS CONTROL** transfers active control of the bus from one controller to another. The HP-IB sequence:
- ATN UNL TAD TCT
- ABORT** terminates all bus transactions, and causes all instruments to listen for a command from the controller. The HP-IB sequence:
- IFC REN  $\overline{\text{ATN}}$

This completes the 12 HP-IB messages.

Table 3-3. The Standard ASCII Code (1 of 3)

ASCII	HP-IB DIO LINES 8 7 6 5 4 3 2 1	Octal	Decimal	Hexadecimal	HP-IB
NUL	X0000000	000	000	00	
SOH	X0000001	001	001	01	GTL
STX	X0000010	002	002	02	
ETX	X0000011	003	003	03	
EOT	X0000100	004	004	04	SDC
ENQ	X0000101	005	005	05	PPC
ACK	X0000110	006	006	06	
BEL	X0000111	007	007	07	
BS	X0001000	010	008	08	GET
HT	X0001001	011	009	09	TCT
LF	X0001010	012	010	0A	
VT	X0001011	013	011	0B	
FF	X0001100	014	012	0C	
CR	X0001101	015	013	0D	
SO	X0001110	016	014	0E	
SI	X0001111	017	015	0F	
DLE	X0010000	020	016	10	
DC1	X0010001	021	017	11	LLO
DC2	X0010010	022	018	12	
DC3	X0010011	023	019	13	
DC4	X0010100	024	020	14	DCL
NAK	X0010101	025	021	15	PPU
SYN	X0010110	026	022	16	
ETB	X0010111	027	023	17	
CAN	X0011000	030	024	18	SPE
EM	X0011001	031	025	19	SPD
SUB	X0011010	032	026	1A	
ESC	X0011011	033	027	1B	
FS	X0011100	034	028	1C	
GS	X0011101	035	029	1D	
RS	X0011110	036	030	1E	
US	X0011111	037	031	1F	
space	X0100000	040	032	20	LA0
!	X0100001	041	033	21	LA1
"	X0100010	042	034	22	LA2
#	X0100011	043	035	23	LA3
\$	X0100100	044	036	24	LA4
%	X0100101	045	037	25	LA5
&	X0100110	046	038	26	LA6
'	X0100111	047	039	27	LA7
(	X0101000	050	040	28	LA8
)	X0101001	051	041	29	LA9
*	X0101010	052	042	2A	LA10
+	X0101011	053	043	2B	LA11
.	X0101100	054	044	2C	LA12
-	X0101101	055	045	2D	LA13
:	X0101110	056	046	2E	LA14
;	X0101111	057	047	2F	LA15
0	X0110000	060	048	30	LA16
1	X0110001	061	049	31	LA17

Table 3-3. The Standard ASCII Code (2 of 3)

ASCII	HP-IB DIO LINES 8 7 6 5 4 3 2 1	Octal	Decimal	Hexadecimal	HP-IB
2	X0110010	062	050	32	LA18
3	X0110011	063	051	33	LA19
4	X0110100	064	052	34	LA20
5	X0110101	065	053	35	LA21
6	X0110110	066	054	36	LA22
7	X0110111	067	055	37	LA23
8	X0111000	070	056	38	LA24
9	X0111001	071	057	39	LA25
:	X0111010	072	058	3A	LA26
;	X0111011	073	059	3B	LA27
<	X0111100	074	060	3C	LA28
=	X0111101	075	061	3D	LA29
>	X0111110	076	062	3E	LA30
?	X0111111	077	063	3F	UNL
@	X1000000	100	064	40	TA0
A	X1000001	101	065	41	TA1
B	X1000010	102	066	42	TA2
C	X1000011	103	067	43	TA3
D	X1000100	104	068	44	TA4
E	X1000101	105	069	45	TA5
F	X1000110	106	070	46	TA6
G	X1000111	107	071	47	TA7
H	X1001000	110	072	48	TA8
I	X1001001	111	073	49	TA9
J	X1001010	112	074	4A	TA10
K	X1001011	113	075	4B	TA11
L	X1001100	114	076	4C	TA12
M	X1001101	115	077	4D	TA13
N	X1001110	116	078	4E	TA14
O	X1001111	117	079	4F	TA15
P	X1010000	120	080	50	TA16
Q	X1010001	121	081	51	TA17
R	X1010010	122	082	52	TA18
S	X1010011	123	083	53	TA19
T	X1010100	124	084	54	TA20
U	X1010101	125	085	55	TA21
V	X1010110	126	086	56	TA22
W	X1010111	127	087	57	TA23
X	X1011000	130	088	58	TA24
Y	X1011001	131	089	59	TA25
Z	X1011010	132	090	5A	TA26
[	X1011011	133	091	5B	TA27
\	X1011100	134	092	5C	TA28
]	X1011101	135	093	5D	TA29
^	X1011110	136	094	5E	TA30
_	X1011111	137	095	5F	UNT
.	X1100000	140	096	60	SC0
a	X1100001	141	097	61	SC1
b	X1100010	142	098	62	SC2
c	X1100011	143	099	63	SC3

Table 3-3. The Standard ASCII Code (3 of 3)

ASCII	HP-IB DIO LINES 8 7 6 5 4 3 2 1	Octal	Decimal	Hexadecimal	HP-IB
d	X 1 1 0 0 1 0 0	144	100	64	SC4
e	X 1 1 0 0 1 0 1	145	101	65	SC5
f	X 1 1 0 0 1 1 0	146	102	66	SC6
g	X 1 1 0 0 1 1 1	147	103	67	SC7
h	X 1 1 0 1 0 0 0	150	104	68	SC8
i	X 1 1 0 1 0 0 1	151	105	69	SC9
j	X 1 1 0 1 0 1 0	152	106	6A	SC10
k	X 1 1 0 1 0 1 1	153	107	6B	SC11
l	X 1 1 0 1 1 0 0	154	108	6C	SC12
m	X 1 1 0 1 1 0 1	155	109	6D	SC13
n	X 1 1 0 1 1 1 0	156	110	6E	SC14
o	X 1 1 0 1 1 1 1	157	111	6F	SC15
p	X 1 1 1 0 0 0 0	160	112	70	SC16
q	X 1 1 1 0 0 0 1	161	113	71	SC17
r	X 1 1 1 0 0 1 0	162	114	72	SC18
s	X 1 1 1 0 0 1 1	163	115	73	SC19
t	X 1 1 1 0 1 0 0	164	116	74	SC20
u	X 1 1 1 0 1 0 1	165	117	75	SC21
v	X 1 1 1 0 1 1 0	166	118	76	SC22
w	X 1 1 1 0 1 1 1	167	119	77	SC23
x	X 1 1 1 1 0 0 0	170	120	78	SC24
y	X 1 1 1 1 0 0 1	171	121	79	SC25
z	X 1 1 1 1 0 1 0	172	122	7A	SC26
{	X 1 1 1 1 0 1 1	173	123	7B	SC27
	X 1 1 1 1 1 0 0	174	124	7C	SC28
}	X 1 1 1 1 1 0 1	175	125	7D	SC29
~	X 1 1 1 1 1 1 0	176	126	7E	SC30
DEL	X 1 1 1 1 1 1 1	177	127	7F	SC31

**ASCII Abbreviations**

<b>NUL</b>	null	<b>VT</b>	vertical tab	<b>SYN</b>	synchronous idle
<b>SOH</b>	start of heading	<b>FF</b>	form feed	<b>ETB</b>	end transmission block
<b>STX</b>	start text	<b>CR</b>	carriage return	<b>CAN</b>	cancel
<b>ETX</b>	end text	<b>SO</b>	shift out	<b>EM</b>	end of medium
<b>EOT</b>	end of transmission	<b>SI</b>	shift in	<b>SUB</b>	substitute
<b>ENQ</b>	enquiry	<b>DLE</b>	data link escape	<b>ESC</b>	escape
<b>ACK</b>	acknowledge	<b>DC1</b>	direct control 1	<b>FS</b>	form separator
<b>BEL</b>	bell	<b>DC2</b>	direct control 2	<b>GS</b>	group separator
<b>BS</b>	backspace	<b>DC3</b>	direct control 3	<b>RS</b>	record separator
<b>HT</b>	horizontal tab	<b>DC4</b>	direct control 4	<b>US</b>	unit separator
<b>LF</b>	line feed	<b>NAK</b>	negative acknowledge	<b>DEL</b>	delete

**HP-IB Abbreviations**

<b>GTL</b>	go to local	<b>LLO</b>	local lockout	<b>LA0-30</b>	listen address
<b>SDC</b>	selected device clear	<b>DCL</b>	device clear	<b>UNL</b>	unlisten
<b>PPC</b>	parallel poll configure	<b>PPU</b>	parallel poll unconfigure	<b>TA0-30</b>	talk address
<b>GET</b>	group execute trigger	<b>SPE</b>	serial poll enable	<b>UNT</b>	untalk
<b>TCT</b>	take control	<b>SPD</b>	serial poll disable	<b>SC0-31</b>	secondary command

### Computer Access of HP-IB Lines

The I/O Programming Guide for the specific computer being used must be consulted for detailed information about direct access to the HP-IB lines; however, the intent of the following discussion is to introduce the fundamental procedures involved in this type of programming. After this introduction, the programmer will know what specific information to look for in the computer's I/O Programming Guide.

### Sending HP-IB Messages

The BASIC statement used to transmit information directly to the HP-IB lines is the SEND statement, which has this syntax:

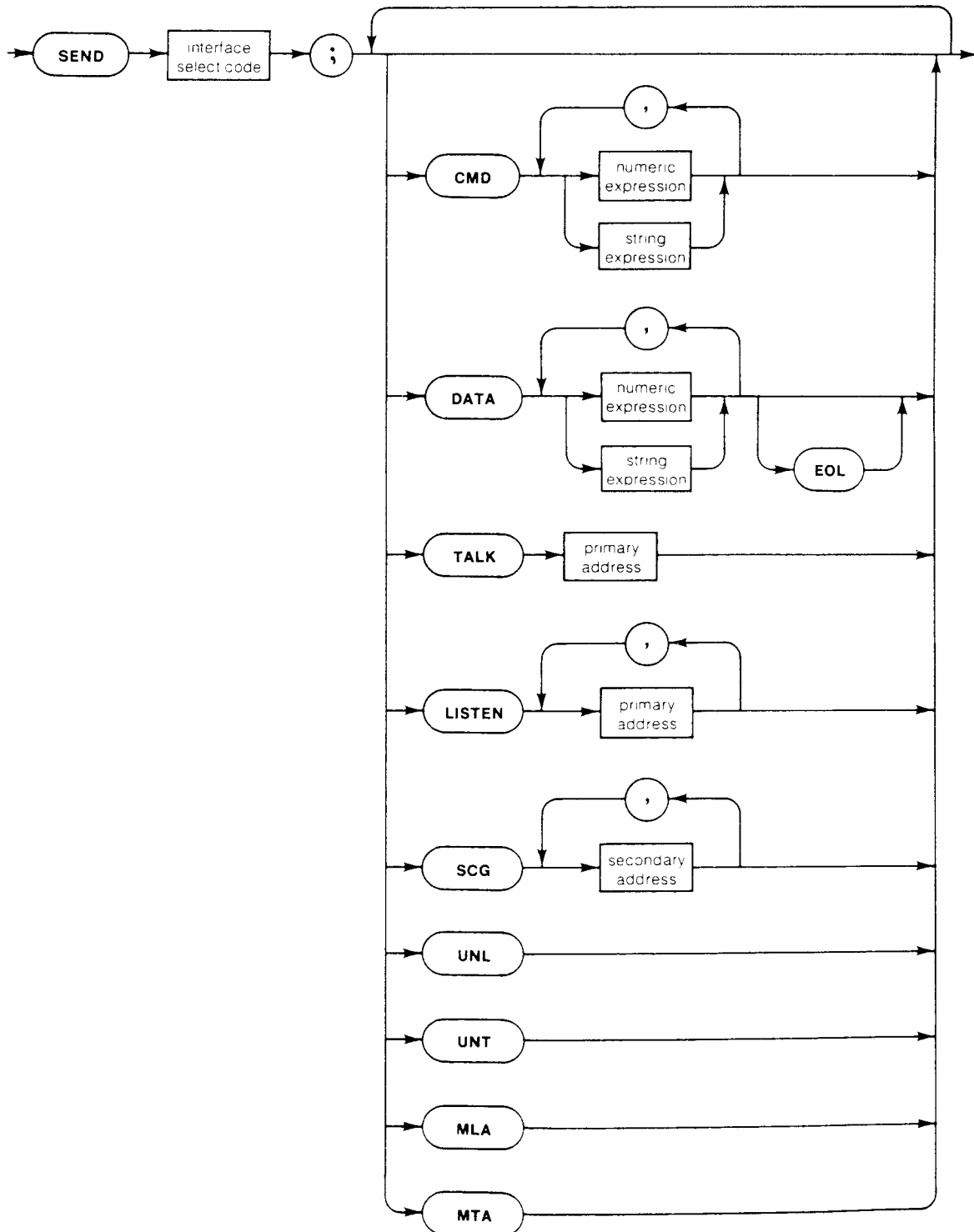

The secondary command DATA sets the ATN line False; all other secondary commands (CMD, TALK, LISTEN, UNL, UNT, MLA, and MTA) set ATN True. Information accompanying the SEND statement can be either ASCII encoded characters that correspond to the HP-IB functions (see Table 3-3), or computer-recognized mnemonics. For example, to read the status bytes from the HP 8341A, the HP-IB sequence is:

UNL MLA (the computer's) TAD (HP 8341A's) SPE (data bytes) SPD UNT

This sequence is accomplished, in BASIC, by using either computer-recognized mnemonics:

```
100 SEND 7; UNL MLA TALK 19 CMD 24
110 ENTER 7 USING "#, B"; S
120 SEND 7; CMD 25 UNT
```

where CMD 24 is SPE, and CMD 25 is SPD; or the same sequence can be accomplished using ASCII encoded HP-IB information:

```
100 SEND 7; CMD "?5S"&CHR$(24)
110 ENTER 7 USING "#, B"; S
120 SEND 7; CMD CHR$(25)&"_"
```

In line 100, ? is the ASCII code for UNL, 5 is a representative MLA, and S is TA19. In line 120, "\_" (underscore) is the ASCII code for UNT. In both examples the ATN line is set True or False by the computer, depending on the context of the mnemonics, and does not require any specific commands.

(This is an illustrative example only; status bytes can be more easily read using a simple OUTPUT "OS" statement.)

### Reading HP-IB Messages

The HP-IB lines are read by examining the computer's status registers, using the STATUS statement. The STATUS statement has this syntax:

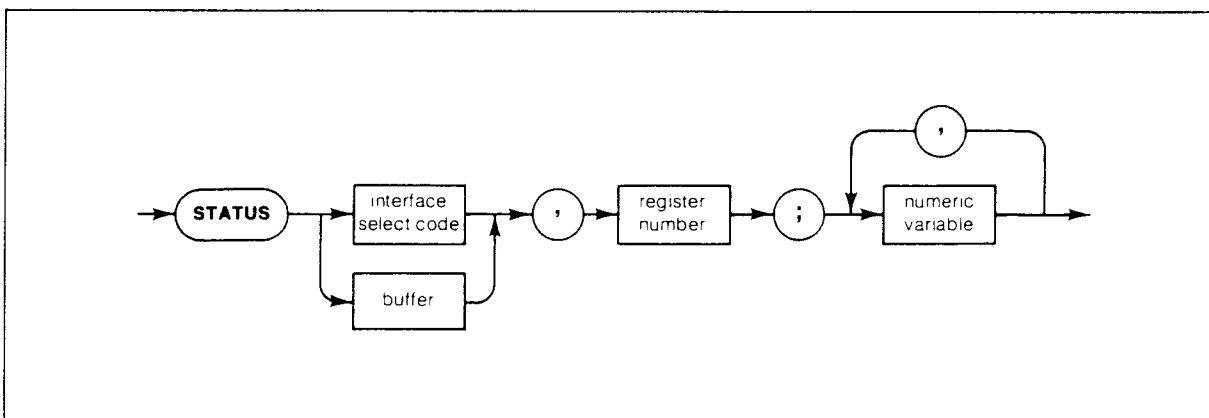

The function assignment of each status register is computer specific. Figure 3-27 shows representative status register assignments, from the HP 9826 and HP-85A computers.



**HP 9826/9836 Status Register 7**

Most Significant Bit

Bit 15	Bit 14	Bit 13	Bit 12	Bit 11	Bit 10	Bit 9	Bit 8
ATN True	DAV True	NDAC* True	NRFD* True	EOI True	SRQ** True	IFC True	REN True
Value = - 32 768	Value = 16 384	Value = 8 192	Value = 4 096	Value = 2 048	Value = 1 024	Value = 512	Value = 256

Least Significant Bit

Bit 7	Bit 6	Bit 5	Bit 4	Bit 3	Bit 2	Bit 1	Bit 0
DIO8	DIO7	DIO6	DIO5	DIO4	DIO3	DIO2	DIO1
Value = 128	Value = 64	Value = 32	Value = 16	Value = 8	Value = 4	Value = 2	Value = 1

\* Only if addressed to TALK, else not valid.

\*\* Only if Active Controller, else not valid.

**HP 85A HP-IB Status Registers**

Status Register Number	Bit Number								Default Value	Register Function
	7	6	5	4	3	2	1	0		
SR0	0	0	0	0	0	0	0	1	1	Interface Identification
SR1	IFC	LA	CA	TA	SRQ	DCL or SDC	GET	SCG	0	Interrupt Cause
SR2	0	REN	SRQ	ATN	EOI	DAV	NDAC	NRFD	64	HP-IB Control Lines
SR3	DIO8	DIO7	DIO6	DIO5	DIO4	DIO3	DIO2	DIO1	Not Applicable	HP-IB Data Lines
SR4	0	0	SC	A4	A3	A2	A1	A0	53	HP-IB Address/ System Controller
SR5	SC	LA	CA	TA	SPE	Parity Error	REN	LLO	160	State Register
SR6	0	0	0	SC5	SC4	SC3	SC2	SC1	0	Secondary Commands

Figure 3-27. Representative Status Registers

Here is a BASIC example of reading the status registers:

```

100 FOR N = 0 TO 6
110 STATUS 7,N; S
120 PRINT "STATUS REGISTER": N
130 PRINT
140   FOR J = 0 TO 7
150     PRINT "BIT":J;"="":BIT(S,J)
160   NEXT J
170 PRINT
180 NEXT N
    
```

**Direct Writing to the HP-IB Lines**

The final programming technique covered in this manual involves direct writing to the HP-IB data, handshake, and control lines. This is very advanced programming, and should be attempted only by experienced programmers who are thoroughly familiar with the HP 8341A and HP-IB protocols.

**CAUTION**

Bus malfunctions or damage can result from errant applications of direct writing to HP-IB lines.

Direct writing to the HP-IB lines is accomplished by the CONTROL statement, which has this syntax:

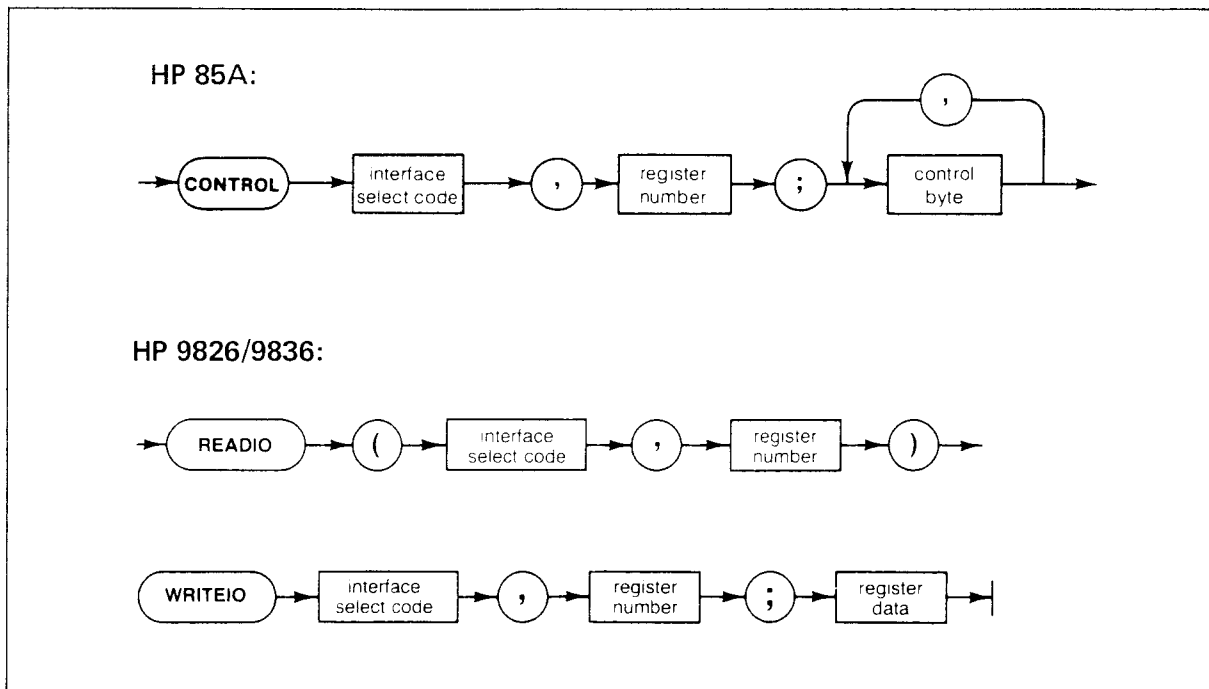

The CONTROL statement (ASSERT, READIO/WRITEIO are related statements used by some computers) is used to send information to the computer's control registers, which have bit patterns that correspond to the HP-IB lines. The bit pattern of the control registers is computer specific; Figure 3-28 shows representative control registers from the HP 9826 and HP-85A computers.

**HP 85A HP-IB Control Registers**

Register Number	Bit Number								Default Value	Register Function
	7	6	5	4	3	2	1	0		
CR0	X	X	X	X	Odd	Even	Always One	Always Zero	0	Parity Control
CR1	IFC	LA	CA	TA	SRQ	DCL or SDC	GET	SCG	0	Interrupt Mask
CR2	X	REN	SRQ	ATN	EOI	DAV	NDAC	NRFD	Not Applicable	HP-IB Control Lines
CR3	DI08	DI07	DI06	DI05	DI04	DI03	DI02	DI01	Not Applicable	HP-IB Data Lines

**HP 9826/9836 HP-IB READIO Register 23**

**Control-Line Status**

Most Significant Bit

Least Significant Bit

Bit 7	Bit 6	Bit 5	Bit 4	Bit 3	Bit 2	Bit 1	Bit 0
ATN True	DAV True	NDAC* True	NRFD* True	EOI True	SRQ** True	IFC True	REN True
Value = 128	Value = 64	Value = 32	Value = 16	Value = 8	Value = 4	Value = 2	Value = 1

\*Only if addressed to TALK, else not valid.

\*\*Only if Active Controller, else not valid.

**HP 9826/9836 HP-IB READIO Register 31**

**Bus Data Lines**

Most Significant Bit

Least Significant Bit

Bit 7	Bit 6	Bit 5	Bit 4	Bit 3	Bit 2	Bit 1	Bit 0
DIO8	DIO7	DIO6	DIO5	DIO4	DIO3	DIO2	DIO1
Value = 128	Value = 64	Value = 32	Value = 16	Value = 8	Value = 4	Value = 2	Value = 1

**HP 9826/9836 HP-IB WRITE10 Register 31**

**Data-Out Register**

Most Significant Bit

Least Significant Bit

Bit 7	Bit 6	Bit 5	Bit 4	Bit 3	Bit 2	Bit 1	Bit 0
DIO8	DIO7	DIO6	DIO5	DIO4	DIO3	DIO2	DIO1
Value = 128	Value = 64	Value = 32	Value = 16	Value = 8	Value = 4	Value = 2	Value = 1

Figure 3-28. Representative Control Registers

The bits in the control registers are set using this statement:

CONTROL 7, (register number); (decimal value of True bits)

To set the bits (and the corresponding HP-IB lines) True (=1), use their corresponding decimal values:

BIT	7	6	5	4	3	2	1	0
DECIMAL	128	64	32	16	8	4	2	1

For example,

100 CONTROL 7,2; 16

sets bit 4 (decimal 16) of control register 2 True, while all other bits in that register are set False. As another example,

100 CONTROL 7,3; 63

sets bits 0-5 True (decimal  $1+2+4+8+16+32 = 63$ ) and bits 6-7 False.

This completes the HP-IB programming information.

## USING THE HP 8341A POWER CONTROL AND MODULATION SYSTEMS.

The preceding explanations of the power control and modulation functions are sufficient for the majority of applications; however, to extract the utmost performance from this instrument the following special information might be helpful.

### INTERNAL LEVELING

The RF Output power is controlled by the automatic level control (ALC) circuit, otherwise referred to as the leveling loop. Figure 3-29 shows a simplified diagram of this system. The leveling loop is a feedback control system, in which the output power is measured and compared to the desired level. If the two are not equal the loop changes the output until they are equal.

The two inputs labeled "ALC INPUTS" convey the desired power level. One of these is a voltage derived from the power value shown in the ENTRY DISPLAY. In the absence of modulation this voltage is used to set the output power level. The amplitude modulation (AM) input causes the output to increase or decrease relative to this level. (The pulse modulation input is essentially on ON/OFF switch, not an ALC input.)

The RF power level from the level control circuits is referred to as the "ALC level," and is measured by a crystal detector. The DC output from this detector is fed back to the level control circuits for comparison with the ALC inputs. Since crystal detectors lose sensitivity at low power levels, the detector provides an accurate power indication for ALC levels down to  $-10$  dBm, and is acceptable ( $\pm 1$ dB) down to  $-20$  dBm. The maximum amount of power available from the level control circuits varies with RF frequency, from  $+10$  dBm specified at 20 GHz to typically  $+21$  dBm at 4.5 GHz; therefore, the level control circuits can provide continuous control of ALC levels over a maximum span of approximately  $-20$  dBm to  $+20$  dBm.

### Coupled Mode

Since many applications require power levels less than  $-20$  dBm, a step attenuator is optionally provided that has a range of 0 to  $-90$  dB in 10 dB steps. Thus, power levels down to  $-110$  dBm is achieved when the attenuator and ALC work in conjunction. Because of the attenuator, the ALC will normally be used over only a portion of its 40 dB range: Since accuracy suffers below  $-10$  dBm and at some frequencies only  $+1$  dBm is available, the ALC is normally set between  $-10$  dBm and 0 dBm. The restricted range of the ALC reduces the primary power span to 0 to  $-100$  dBm. To get power less than  $-100$  dBm, the attenuator is left at  $-90$  dB, and the ALC used from  $-10$  to  $-20$  dBm; however, the ALC accuracy and noise performance is degraded at this level, and is the reason that some specifications apply only down to  $-100$  dBm. At frequencies where power levels above 0 dBm are desired, the attenuator is left at 0 dB and the ALC used from 0 to  $+20$  dBm (or whatever power is available at the RF frequency in use). The proper combination of ALC and attenuator is decided by the internal microprocessor: the user need only set the desired power in the ENTRY DISPLAY via the [POWER LEVEL] key.

### POWER dBm Display

If the requested power is greater than can be provided, the level control loop will provide maximum available power and light the UNLEVELED annunciator. When unlevelled, the output power does not equal the value shown in the ENTRY DISPLAY. The internal detector is monitoring the actual power, however, and its output voltage controls the POWER dBm display. The detector voltage is interpreted to give ALC level, and the attenuator setting is subtracted to yield actual output power, even when unlevelled.

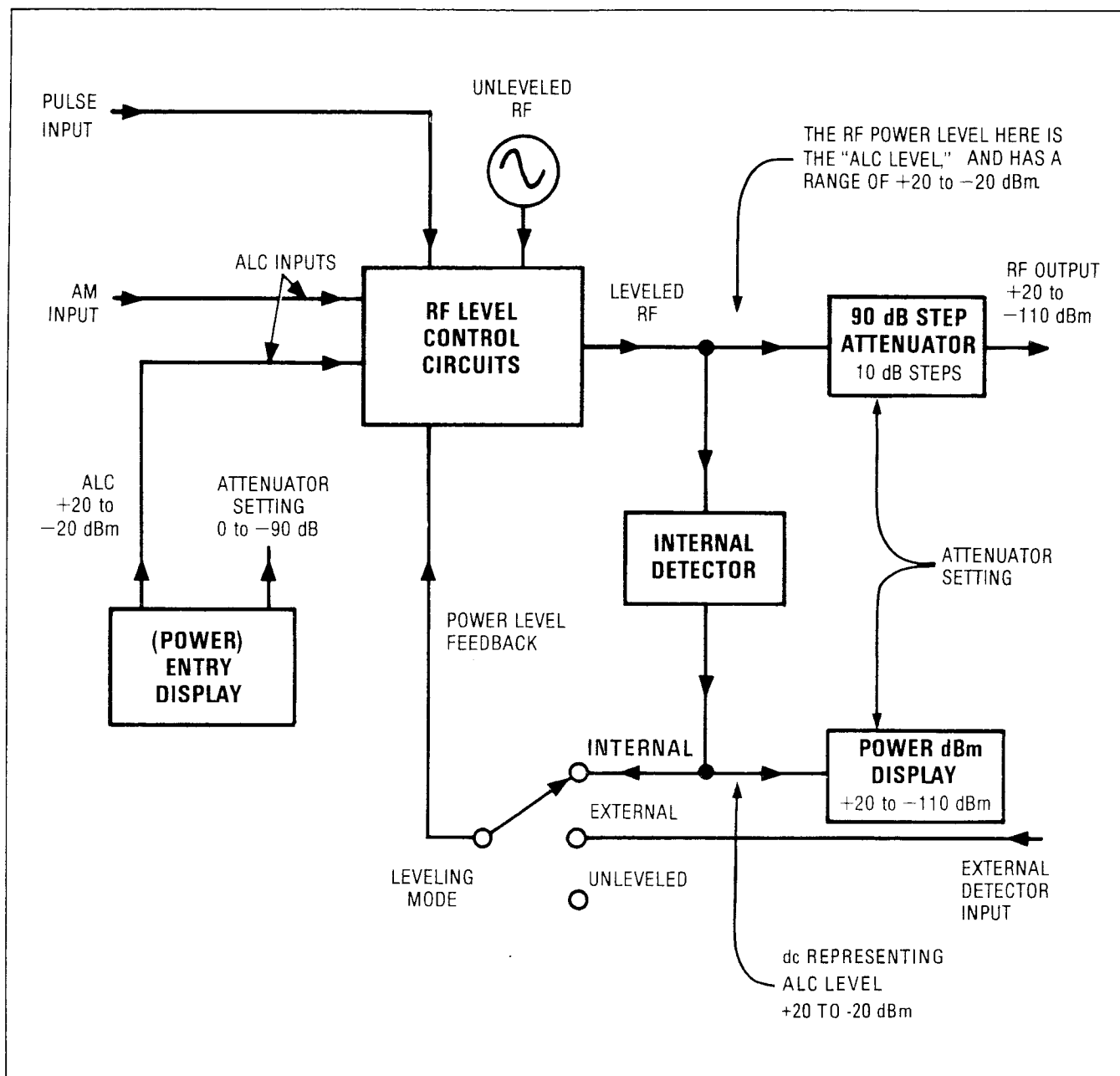

Figure 3-29. ALC Loop Block Diagram

The AM input is DC coupled, and a DC input will change the output power. This change does not appear in the ENTRY DISPLAY, but the POWER dBm display accurately indicates the real output.

When internally leveled, UNLEVELED annunciator off, and AM off the POWER dBm display simply repeats the value shown in the ENTRY DISPLAY. When externally leveled, or the UNLEVELED annunciator is on, or AM modulation is in effect the POWER dBm display indicates the ALC level and reflects the true output power. This might not agree with the ENTRY DISPLAY value, which shows the desired level in the absence of modulation.

The above should be understood when using power sweep. When the POWER dBm display is repeating the ENTRY DISPLAY, it indicates start power. If the POWER dBm display is indicating ALC level, it shows the average power over the sweep. (The circuit is heavily filtered above 5 Hz.) Since the start and stop dwell times are unequal, this average reading has little meaning.

In a variety of situations it is possible to drive the ALC level below  $-20$  dBm, such as putting DC into the AM input, or when externally leveled. Since the internal detector is inaccurate at these levels, the POWER dBm display would be very misleading. For that reason, and as a warning, the POWER dBm display blanks at ALC levels below  $-22.0$  dBm. This may occur at an output power of  $-22$  dBm,  $-32$  dBm,  $-42$  dBm, etc., depending on the attenuator setting.

### Decoupled Mode

In some applications it is advantageous to control the ALC and optional attenuator separately, achieving combinations of settings which are not available in the coupled mode. Press **[SHIFT] [PWR SWP]** to activate decoupled mode, which causes "ATTN: \_\_\_\_\_dB, ALC: \_\_\_\_\_, \_\_\_\_\_ DbM" to show in the ENTRY DISPLAY. The ALC setting is entered via keypad or **[KNOB]**, while the attenuator is incremented with the step keys. As before, the POWER dBm display indicates the true, composite output power. (Caution: If an entry is made in decoupled mode, and subsequently **[POWER LEVEL]** is pressed, the HP 8341A reverts to coupled mode. It will set itself to the same power level, but the attenuator and ALC settings may be different.)

One use of decoupled operation is power sweep, where the output power linearly tracks the sweep voltage ramp. The HP 8341A can generate power sweeps of up to 40 dB, depending on frequency. The power at the start of the sweep is set via **[POWER LEVEL]** (coupled operation) or **[SHIFT] [PWR SWP]** (decoupled operation), and the sweep range (the amount the power increases during the sweep) is entered by pressing **[PWR SWP]** followed by the desired dB sweep value. If the sweep range entered exceeds the ALC range (stop power greater than maximum available power) the UNLEVELED annunciator will light at the end of sweep. No warning is given at the time of entry. If the start power is entered via the **[POWER LEVEL]** key, the ALC is set no lower than  $-10$  dBm, limiting available power sweep range to 30 dB at 4.5 GHz, or 19 dB (with Opt. 001) at 20 GHz. Using decoupled mode and setting the ALC to  $-20$  dBm gives an additional 10 dB of sweep range (although at  $-20$  dBm, start power uncertainty is degraded by  $\pm 1$  dB).

Decoupled mode is also useful when working with mixers. Figure 3-30A shows a hypothetical setup where an HP 8341A is providing the small signal to a mixer. The HP 8341A output is  $-8$  dBm, which in coupled mode results in ALC =  $-8$  dBm, ATTN = 0 dB. The mixer is driven with an LO of  $+10$  dBm, and has LO to RF isolation of 15 dB. The resulting LO feedthrough of  $-5$  dBm enters the HP 8341A's OUTPUT port, goes through the attenuator with no loss, and arrives at the internal detector. Depending on frequency, it is possible for most of this energy to enter the detector. Since the detector responds to its total input power regardless of frequency, this excess energy causes the leveling circuit to reduce its output. In this example the reverse power is actually larger than the ALC level, which may result in the HP 8341A output being shut off.

Figure 3-30B shows the same setup, with decoupled mode used to give a  $-8$  dBm output: ALC =  $+2$  dBm, ATTN =  $-10$  dB. The ALC is 10 dB higher, and the attenuator reduces the LO feedthrough by 10 dB. Thus the detector sees  $+2$  dBm desired signal versus a possible  $-15$  dBm undesired one. This 17 dB difference results in a maximum 0.1 dB shift in the HP 8341A's output level.

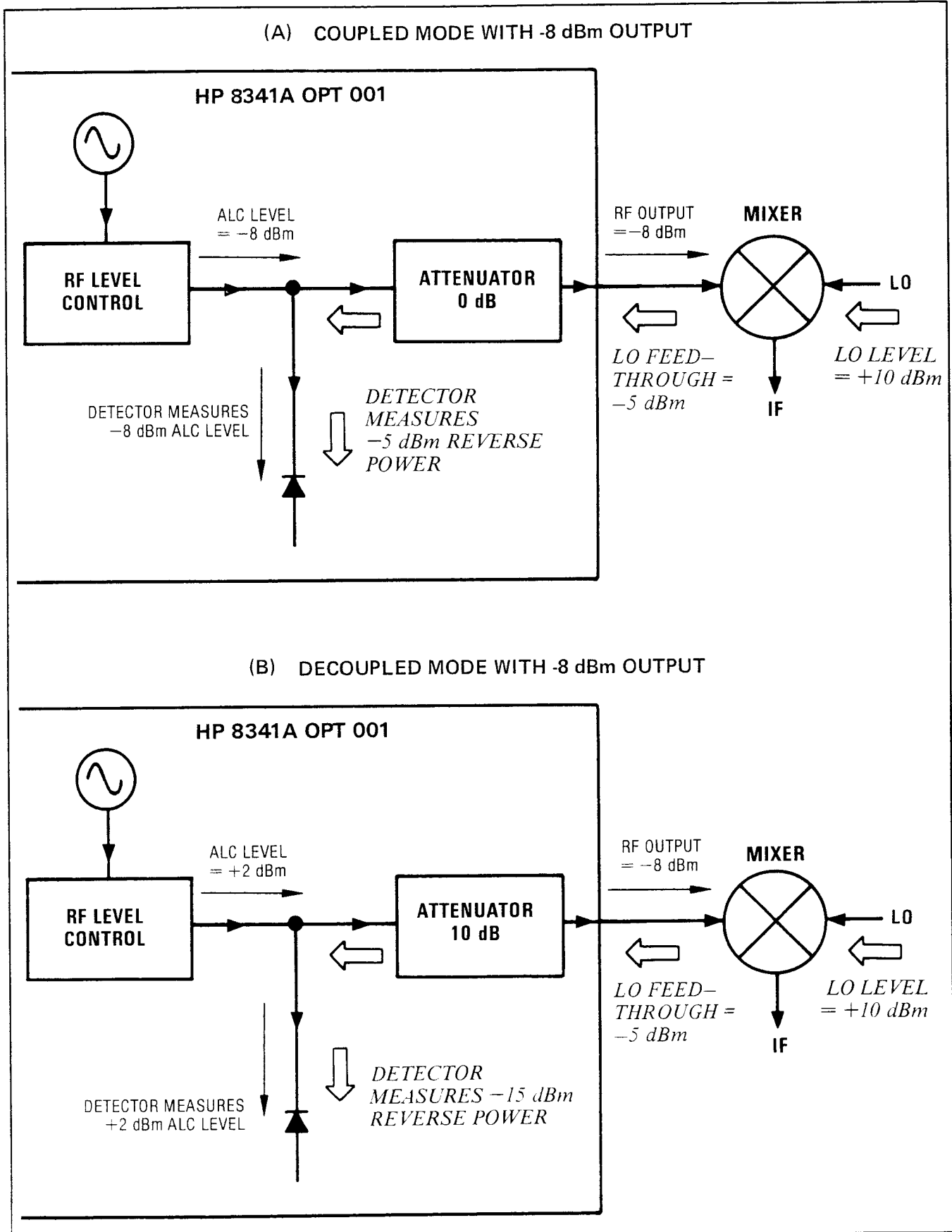

Figure 3-30. Reverse Power Effects



Reverse power is a problem with spectrum analyzers that do not have preselection capability. Some analyzers have as much as +5 dBm LO feedthrough coming out of their RF input, at some frequencies. The effects of reverse power are less in the heterodyne band (.01 to 2.3 GHz) where the power amplifier provides some broadband matching. Similarly, from 2.3 to 20 GHz, reverse power that is within 10 MHz of the HP 8341A's frequency may be partially absorbed by the YIG filter. If the frequency difference is small enough to be within the leveling loop bandwidth (typically 10 kHz CW, 200 kHz sweep or AM), the effect of reverse power is amplitude modulation of the HP 8341A's output. The AM rate equals the difference in RF frequencies. Reverse power problems may be treated by using the unlevelled mode, as described in that section.

When using decoupled mode to set low ALC levels, some caution is necessary. At ALC = -20 dBm, the amplitude accuracy degrades by  $\pm 1$  dB. This results from temperature induced drift in the detection circuitry. Some spurious signals, such as ac power line related sidebands, are worse at -20 dBm and may exceed specifications (which do not apply at ALC = -20 dBm). Despite its level uncertainty, the output power at ALC = -20 dBm is more stable than a normal power meter. In checking the output, care must be taken to zero the meter with the HP 8341A's RF turned off. Pressing the "sensor zero" button on a power meter does not assure that it is zeroed, since the display on some meters is blank for inputs below -30 dBm when in the "dBm" mode. Selecting the "WATT" mode keeps the display alive, and the user can then see if the meter is really zeroed (press the zero button several times if necessary).

When the HP 8341A's heterodyne band (.01 to 2.3 GHz) is in use, approximately -30 dBm of broadband noise is generated along with the desired signal. If the desired signal is -20 dBm and the result measured on a power meter, the reading will be about 0.5 dB high. To accurately measure the signal, the power meter must be zeroed in the presence of the noise: Connect the power meter, then press [RF] to shut off any RF output; although the RF is off, the noise is still present and the power meter can now be zeroed. When going to frequencies above 2.3 GHz, the meter must be re-zeroed. The broadband noise is attenuated by the step attenuator, along with the desired signal. Noise makes a 0.05 dB contribution at ALC = -10 dBm.

## UNLEVELED MODE

The HP 8341A has a power control mode in which the leveling feedback loop is opened. The ALC inputs are used to directly control the RF modulator. Pressing [SHIFT] [METER] activates this mode. The annunciators on the leveling mode keys are extinguished, the UNLEVELED annunciator is lighted, and the ENTRY DISPLAY shows: ATTN: \_\_\_\_\_ dB, MOD: \_\_\_\_\_ . \_\_\_\_\_ dB. As with the decoupled mode, the attenuator (Opt. 001, 004) is set via the [STEP] keys, and the modulator entry is made with keypad or [KNOB]. The entry range is 0 to -100 dB. The modulator entry is an approximately calibrated relative indication, because the modulator's gain and maximum output change with frequency. See Figure 3-31.

AM works in this mode with unspecified distortion. Pulse modulation works. Power sweep works with linearity as depicted in Figure 3-31. The POWER dBm display still indicates actual output power. As with other leveling modes, it indicates the sum of "ALC level" and attenuation, with useful accuracy down to ALC levels of -20 dBm. It blanks at ALC levels below -22 dBm. Sweeps will, of course, be unlevelled. When in the unlevelled mode, there is no feedback stabilization of power, and its stability versus time and temperature is unspecified.

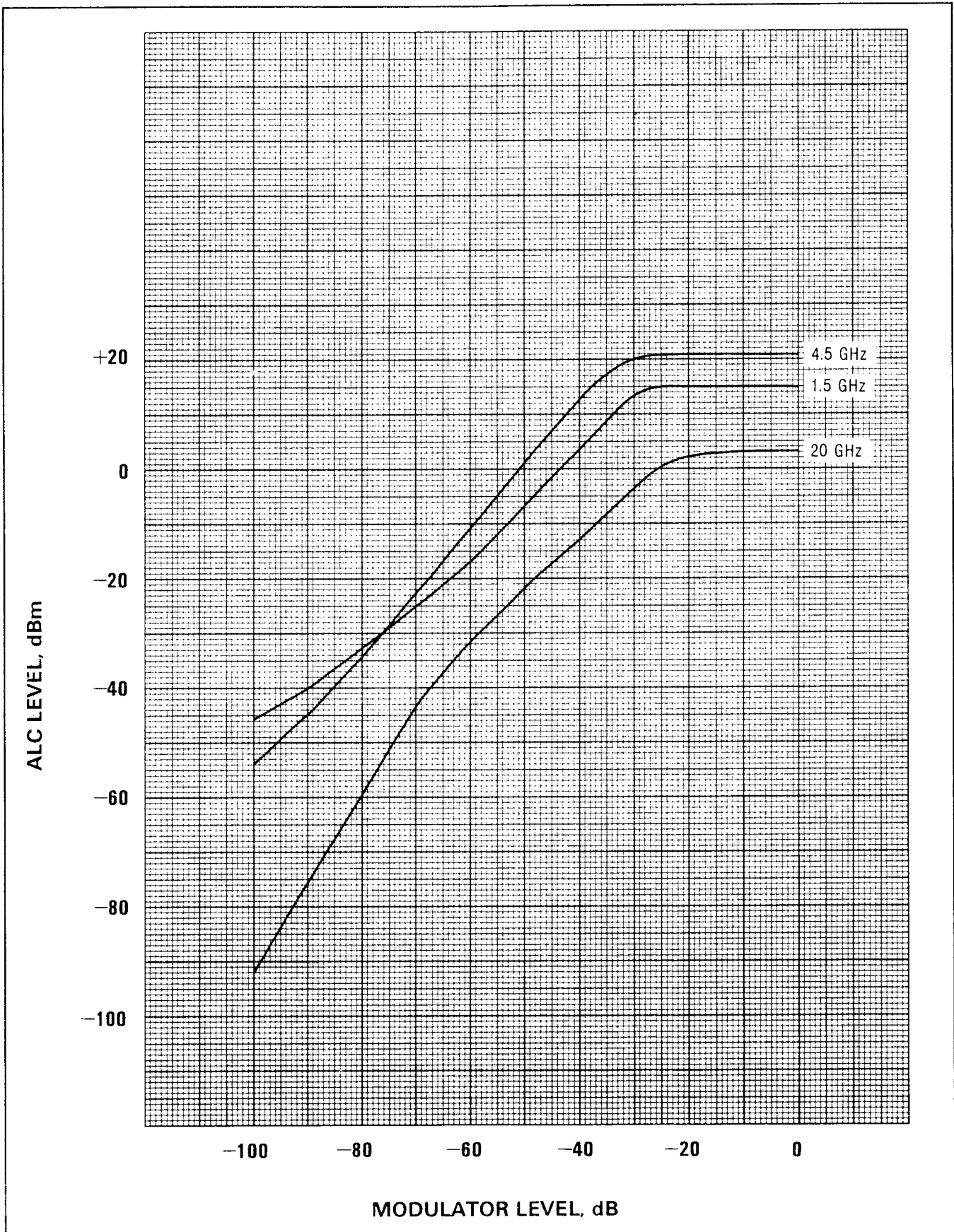

Figure 3-31. Typical Unleveled Modulation Response

This mode is useful for signal tracing while troubleshooting the HP 8341A. It is also useful in some pulse modulation applications, as explained in that section. It can also be used to set output in the presence of large reverse power (a problem described under "decoupled mode"). To do so, the reverse power's effect on the POWER dBm display must be eliminated by shutting that power off, or temporarily setting the HP 8341A's attenuator to a high value. Then, in the unlevelled mode (SHIFT METER), use the knob to set the desired ALC level via the power dBm display (remember to mentally compensate for any attenuation in use). Then remove attenuation or turn on the reverse power. In the presence of reverse power, the POWER dBm display will change to an incorrect value, but the output power will be as previously set.

### EXTERNAL LEVELING

In externally leveled operations, the output power from the HP 8341A is detected by an external sensor. The output of this detector is returned to the HP 8341A's leveling circuits, and the output power is automatically adjusted to keep the power constant at the point of detection. Figure 3-32 shows a basic external leveling arrangement. The output of the detected arm of the splitter or coupler is held constant. If the splitter response is flat, then the output of the other arm will be constant also. This arrangement offers superior flatness over internal leveling, especially if long cables are involved. For best flatness a good resistive splitter with power meter detection should be used.

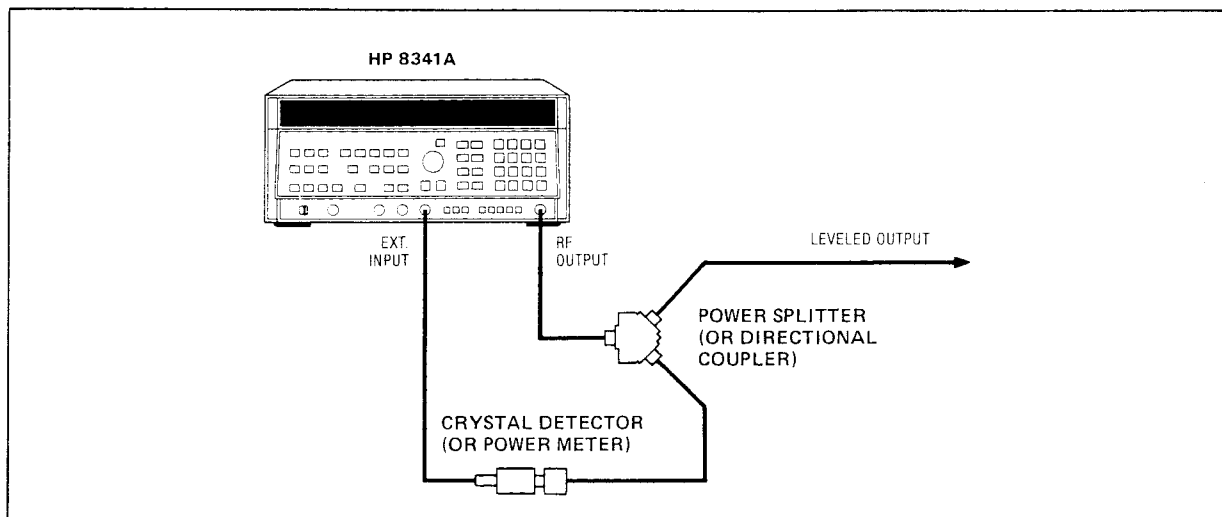

Figure 3-32. Typical External Leveling Hookup

Reference to Figure 3-29 indicates that when externally leveled, the power level feedback is taken from the external detector input rather than the internal detector. This feedback voltage is what the loop is trying to control. For a given ALC input, the loop will adjust its output until the feedback is, for instance, 10 mV. The type of coupler or detector has no influence on this — if the loop is able, it will drive the feedback to the requested level. Since there is no inherent relationship between ALC input and the amount of externally leveled RF power, the power level ENTRY DISPLAY shows the feedback voltage which the loop is seeking. This voltage is called the reference voltage and is displayed alongside the attenuator setting as ATTN: \_\_\_\_\_ Db, REF: \_\_\_\_\_ . \_\_\_\_\_ dBV. The entry units are dBV (dB relative to 1 volt), where 1.00 V = 0 dBV, 0.1 V = -20 dBV, etc. As with the decoupled mode of internal leveling the REF is set with the keypad or [KNOB] while the attenuator (Opt. 001, 004) is set with the [STEP] keys. The attenuator will normally be left at 0 dB. Its use is described below.

The reference voltage may be set over a range of  $-66$  dBV (.0005V) to  $+6$  dBV (2.00V). This wide range accommodated a variety of detectors and leveling situations. The input accepts either positive or negative voltages automatically. For example, with REF =  $-20$  dBV, the loop will level with an input of either  $+0.1$ V or  $-0.1$ V. The input will accept overloads of  $\pm 25$  volts with no damage. The input resistance is  $1\text{ M}\Omega$ . Figure 3-33 shows the input power versus output voltage characteristics for typical HP crystal detectors. From the chart the leveled power at the crystal detector input resulting from any reference setting may be determined. The range of power adjustment is approximately  $-30$  dBm to  $+18$  dBm.

### Detector Characteristics

As shown in Figure 3-33, crystal detectors may be characterized by three operating regions. In the square law region ( $P_{in} < -20$  dBm) the output voltage is proportional to the square of the input voltage, in other words proportional to input power. In the linear region ( $P_{in} + 5$  dBm) the output voltage is directly proportional to the input voltage. Because of this, when leveling in the linear region a 1 dB reference change causes a 1 dB power change, while in square law a 1 dB reference change causes a 1/2 dB power change. This should be understood when using power sweep or AM. The power sweep function will sweep the reference by up to 40 dB, but if a square law detector is being used, the power will only sweep 20 dB. The power sweep will only be linear if the operation is entirely in square law or entirely in linear. In the transition region, the power sweep will be non-linear. As may be seen in Figure 3-33 by drawing a line between  $-10$  dBV and  $-50$  dBV, the worst deviation from a straight line is 13 dB of reference voltage, or 2 dB of RF power. The Amplitude modulation system is designed to be linear with a square law detector. With a linear detector, the modulation depth will be more than expected, and there will be significant distortion.

HP power meters have a rear panel output ("recorder" output) which responds linearly with power. The output is  $+1.00$ V for full scale on whatever range is selected,  $+0.50$ V for 3 dB below full scale,  $+0.10$ V for 10 dB below full scale. These numbers may be seen directly on the 0 - 1 "WATTS" scale on an analog power meter (e.g., HP 432, 435). This response is the same as a square law detector, so all the comments above for such detectors apply to power meters.

Setting the desired power with a non-autoranging meter (HP 432, 435) is straightforward. Assume  $+3$  dBm is desired at the power sensor. Set the power meter on the  $+5$  dBm range, so the desired power is 2 dB below full scale. Since the RF power changes 1/2 dB for each 1 dB reference change, set the reference for  $-4$  dBV.

Auto ranging meters (e.g., HP 436, 438) must be used in their range hold modes to prevent range change during blanking or other RF-off intervals. To lock the meter to the desired range, internal leveling must be used. Adjust the HP 8341A output power until the meter is on the desired power range, then press range hold. As an example, consider the HP 436: The HP 436 changes ranges every 10 dB, so if  $-8$  dBm is desired, the reference must be set for 8 dB below full scale (REF =  $-16$  Dbv) with the HP 436 locked on the  $-10$  to 0 Dbm range. (Caution: the HP 436 range change circuits have intentional hysteresis. Setting the power to 0 dBm may place the meter on either the  $-10$  to 0 range or the 0 to  $+10$  range. For no ambiguity, force the meter to the middle of the range ( $-5$  dBm,  $+5$  dBm, etc.), then press range hold.)

### POWER dBm Display used with the Attenuator (Opt. 001, 004)

Some external leveling applications require low output power from the HP 8341A, for example, leveling the output of a 30 dB amplifier to a level of  $-10$  dBm. In this application, the output of the HP 8341A is around  $-40$  dBm when leveled. At some frequencies this level is beyond the range of the ALC modulator alone. If so, the OVERMOD annunciator lights. Inserting 40 dB of step attenuation results in an ALC level of 0 dBm, which is well within the range of the ALC.

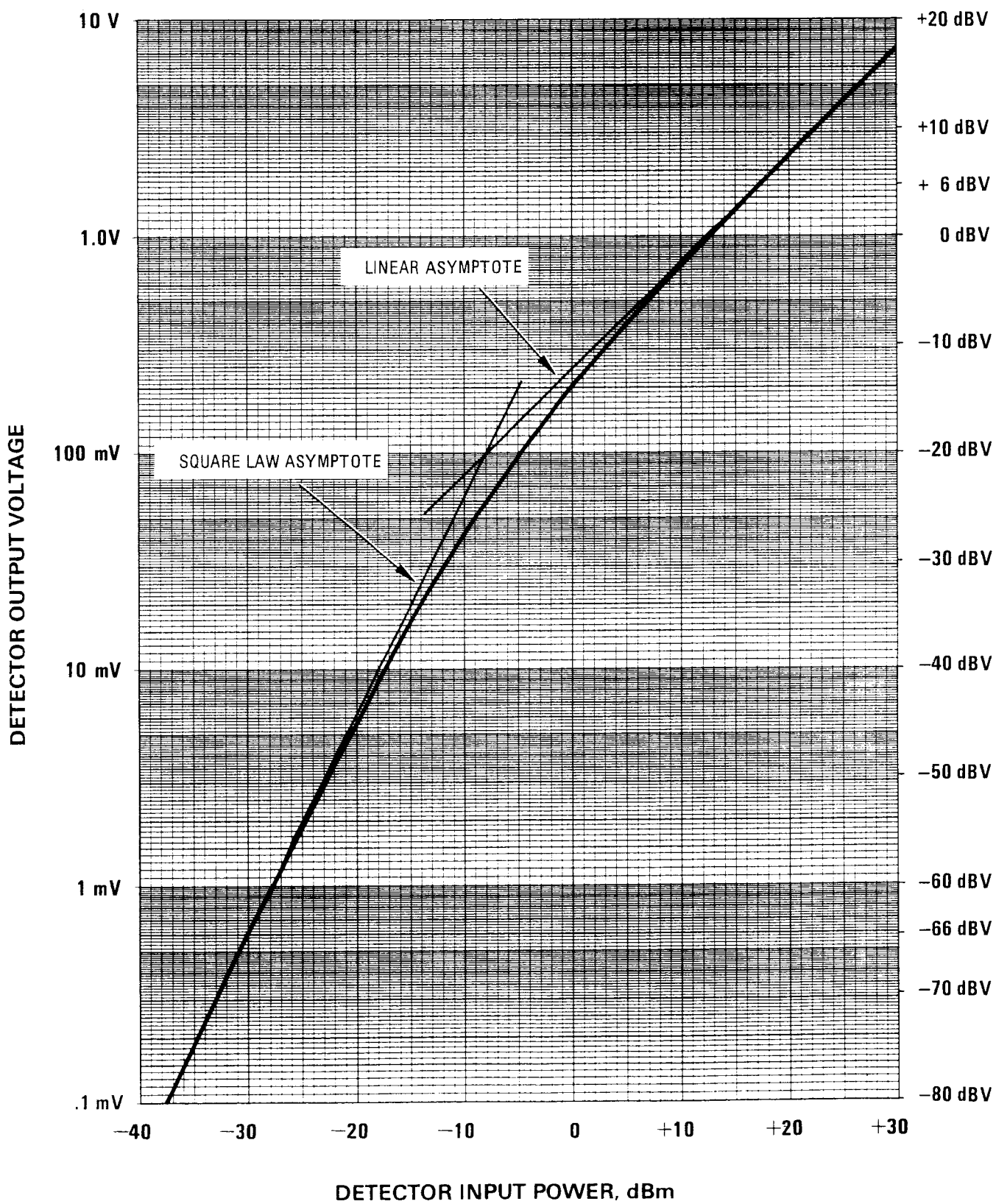

Figure 3-33. Typical Crystal Detector Response at 25°C

Referring to Figure 3-29, it is seen that when externally leveled the POWER dBm display is still connected to the internal detector of the HP 8341A. Thus, it always tells the true output power, regardless of external leveling setup. This is a useful aid to determining if the external hardware is functioning properly. In the above example, if the POWER dBm display shows  $-40$  dBm when the amplifier output is leveled to  $-10$  dBm, the user knows the gain is 30 dB. As explained in the internal leveling section above, the POWER dBm display is only accurate down to ALC levels of about  $-22$  dBm, below which it is intentionally blanked. Therefore, that display is only useful if the ALC level is forced to be greater than  $-22$  dBm. This is done by inserting step attenuation until the display lights up again. As still more attenuation is added, the POWER dBm reading remains essentially constant as the external leveling loop holds the output level constant. With each additional 10 dB step of attenuation, the ALC level jumps 10 dB, until finally maximum available ALC level is reached and the UNLEVELED annunciator lights. For best display accuracy and minimum noise, the ALC level should be greater than  $-10$  dBm. This is achieved by using attenuation equal to the tens digit of output power. Example: output power =  $-43$  dBm; use ATTN. =  $-40$  dB, ALC =  $-3$  dBm.

When sweeping while externally leveled, the output power changes with frequency in order to level at a distant point. The POWER dBm display tries to follow this change. Due to its heavy filtering, at fast sweep speeds the meter displays an average power level.

When using mixers, or in other situations where reverse power may be encountered, caution is necessary. See the decoupled mode and unleveled mode sections above. Reverse power into the HP 8341A when externally leveled makes the POWER dBm display read incorrectly; unwanted RF energy entering the external detector causes the loop to level at the wrong power level.

### Bandwidth

When externally leveled, the leveling loop bandwidth differs from what it is when internally leveled. If AM is on or when sweeping with sweep time  $< 5$  seconds, the nominal loop bandwidth is:

Internal: 150 kHz

External, crystal: 30 kHz with square law detector, 15 kHz with linear detector.

External, power meter: 0.7 Hz

The significance of loop bandwidth is that it generally equals AM bandwidth and influences the fastest useable sweep speed. The best way to set sweep speed is to reduce it until measured flatness no longer changes. For the sake of understanding — observe a plot of unleveled flatness across the band of interest. The number of ripples divided by sweep time gives the number of “ripples per second” which the leveling loop must remove. The loop bandwidth must be several times this number in order to do so. From the above it is apparent that the useable sweep time will depend on frequency range and RF hardware in use. When using long cables there will be many ripples, and their amplitude is dependent on the match at each end of the cable. Inserting 10 dB of step attenuation greatly improves the source match when externally leveled, thereby reducing the ripple amplitude.

For best stability of the leveling loop, the video bandwidth of the external detector should be 50 kHz or more when XTAL leveling is selected. The capacity of coaxial cables reduces the video bandwidth of crystal detectors. A typical point-contact detector (HP 420 series, 423A, 8470A) will work with up to 15 feet of  $50\Omega$  coax on its output. Typical HP low barrier schottky detectors (HP 423B, 8470B, 33330 series) will drive up to 100 feet of  $50\Omega$  cable. If using a very slow detector, selecting METER leveling may work.

The above paragraph applies to square law detectors with no dc offset ( $V_{out} = 0$  for  $P_{in} = 0$ ). The following formula gives nominal loop bandwidth for arbitrary detectors (XTAL leveling):

$$BW = (\Delta V \div V_{out}) \times 120 \text{ KHz}$$

WHERE  $V_{out}$  = dc output voltage at point of interest

$\Delta V$  = change of dc output for a 1 dB RF input change

Some unusual detectors might result in a large loop bandwidth, requiring that the detectors themselves have several times that bandwidth. Loop oscillation in XTAL mode may be encountered with loop bandwidth above 100 KHz, regardless of detector bandwidth.

In METER mode, the external leveling bandwidth is reduced to 0.7 Hz in order to allow operation with power meters. Power meters have a very slow response due to thermal delay time and heavy electrical filtering. The 0.7 Hz bandwidth assures proper operation with any HP power meter on any range. The HP 435 and 436 switch in very slow filters on their most sensitive ranges. If only the high power range is used, the loop will be stable with a higher loop bandwidth and a faster sweep can be used. The loop bandwidth can be increased by reducing the size of component A25C37. Use only a good film capacitor to avoid dc leakage problems. If this component is changed oscillations may be encountered using the bottom ranges of an HP 435/436.

When turning on the RF power, either when unblanking or using the RF key, the slow response of the power meter can cause serious power overshoot in some external leveling systems. This overshoot may damage active devices or some power sensors. To prevent this problem in the HP 8341A, a slow turn on circuit is employed when METER leveling is selected. This circuit raises the power slowly over a period of 2 seconds. The sweep generator automatically waits for this settling time to end before beginning a sweep.

Amplitude modulation is possible when power meter leveled. The system provides linear AM and is dc coupled. For rates below 0.7 Hz, the leveling is done via the power meter sensor and behaves just like internal leveling. Above 0.7 Hz, feedback from the power meter rolls off and is replaced by feedback from the HP 8341A's internal detector. Thus, high frequency envelopes are under control of the internal detector, while the power meter controls the power level. The modulation depth is still accurate and the bandwidth is nominally 30 KHz. The power sensor is not following the modulation; hence, it will average the power. When modulating with a sinusoid symmetric about 0V, the average output power increases (by 50% for 100% AM). The power sensor senses this increase and reduces the HP 8341A's output until the average equals what the power was with no modulation. As long as the modulation depth remains constant across the frequency band (use moderate rates and depths), this system will level the power while providing amplitude modulation.

## AMPLITUDE MODULATION

The HP 8341A provides linear, dc coupled amplitude modulation when internally leveled or externally leveled with a square law detector or power meter. The input resistance is  $600\Omega$  whether the AM function is on or off. The sensitivity is 100% per volt  $\pm 5\%$ . This means that +1.0 volt doubles the output voltage (+6 dB), while -1.0 volt shuts the output completely off. The input accepts  $\pm 15$  V dc with no damage, and is resistor-diode clamped to protect against higher voltage transients. Most sine wave generators are calibrated in terms of RMS voltage, so 0.707 V RMS equals 1.00 V peak. The generator's output meter is accurate only if the load impedance equals the source impedance.

### POWER dBm Display used with AM

The POWER dBm display on the HP 8341A always tells actual output power. A dc input to the AM jack causes the power level to shift, and the display reflects this: + 1.0 volt causes the display to increase 6 dB. If that much power is not available, the UNLEVELED annunciator lights and the display shows the actual output. Inputs which reduce the ALC level below -22 dBm will blank the display. Inputs of -1.0 volt or more negative shut off the output and light the OVERMOD annunciator.

The POWER dBm display is filtered so that it will not flicker for AM rates above 20 Hz. The filtering creates an average of RF voltage, which is then displayed as power in a  $50\Omega$  system (dBm,  $50\Omega$ ). Therefore, modulation inputs with no dc component do not cause the POWER dBm display to shift, and this displayed number represents the power of the unmodulated carrier. A power meter measurement of output power changes with modulation present, increasing 1.76 dB with 100% deep sinusoidal, no dc component modulation. Attempted deep modulation at high rates causes the POWER dBm display to shift, because the AM system cannot keep up with the input and the resultant high distortion causes a shift in average power.

### Dynamic Range

As mentioned previously with reference to Figure 3-29, the AM input is an ALC input which does not differ in its effect from a power entry input. Therefore, the AM system is limited by where it is operating within the ALC range. In the normal "coupled" operating mode (Opt. 001, 004), the ALC will likely be set between -10 dBm and 0 dBm (see the preceding pertinent section). Depending on frequency, the maximum available power is between +10 dBm and +21 dBm. The ALC is reasonably accurate down to -20 dBm, and typically is well behaved to about -30 dBm. Expressing the desired modulation depth in dB's will let the user determine the range over which the ALC loop is being exercised. Thirty percent AM creates excursions of +2.3 dB to - 3.1 dB, relative to the quiescent level; 50%: +3.5 dB to -6.0 dB; 90%: +5.6 dB to - 20.0 dB. (The above assumes a modulation waveform symmetric about 0 V.)

For example: Output power = -19.0 dBm. In coupled mode this results in ATTN = -10 dB, ALC = -9.0 dBm. Ninety percent modulation depth results in an ALC range of -9.0 dBm + 5.6 dB = -3.4 dBm maximum, -9.0 dBm - 20 dB = - 29.0 dBm minimum. This is within the ALC limits at any frequency but the distortion may suffer due to operation below -20 dBm. Using decoupled operation the desired output power may be set with ATTN = -20 dB, ALC = +1.0 dBm. Then 90% depth swings the ALC from +6.6 dBm to -19.0 dBm. The distortion will probably be better under these conditions. At some frequencies +20 dBm is available, and setting ATTN = -30 dB, ALC = +11.0 dBm may give a further improvement, especially if attempting greater than 90% depth. For minimum distortion the ALC should be used between -15 dBm and +15 dBm, but not within 2 dB of maximum available power.

### Bandwidth for AM Applications

The small signal AM bandwidth extends from dc to a -3 dB frequency of at least 100 KHz. The actual upper limit is a direct function of the loop gain of the ALC loop. The primary variable in the loop gain is the gain of the modulator, which varies with both power level and frequency. In general, the modulator gain deviates the most from nominal at power levels just below maximum, although at some frequencies the gain will deviate at lower power levels because of non-optimum YTM bias. The latter is only a problem above 7.0 GHz. The small signal (30% depth) bandwidth may be expected to vary between 100 KHz and 300 KHz as power and/or frequency is changed. The bandwidth for greater depths is less. At 90% depth expect about 1/5 the 30% bandwidth.



The above bandwidths are for internal leveling. When external leveling with a crystal detector in its square law region the bandwidth is 1/5 of the internally leveled bandwidth at the same frequency and output power level. With a crystal detector in its linear region, the bandwidth is 1/10. For other detectors see the external leveling section.

The external leveling system is designed to provide linear AM when using a square law detector. The RF output follows this law:  $V_{out} = V_o \times (V_{in} + 1)$ .

This applies also to internal leveling. When externally leveled with a linear detector the relationship is

$$V_{out} = V_o \times (V_{in} + 1)^2$$

A power meter is a square law detector, so AM with power meter leveling is linear. For bandwidth see the external leveling section.

For simultaneous AM and pulse modulation, see the next section.

### **PULSE MODULATION (Opt. 006)**

The HP 8341A provides leveled pulse modulation over a wide range of pulse widths and rates. Characteristics such as leveling accuracy and response time vary with pulse width, pulse rate, temperature, power level, and RF frequency. In order to use the pulse leveling system to best advantage it is helpful to understand its operation and limitations.

#### **Sample and Hold Leveling**

The basic leveling loop was previously explained with reference to Figure 3-29. Fundamental to its operation is the internal detector which measures the RF amplitude. The leveling performance is limited by the accuracy of this measurement. The most difficult aspect of leveled pulse modulation is measuring the amplitude of a very narrow RF pulse.

Figure 3-34 is a block diagram of the detector circuitry, with waveforms. Trace 1 is the pulse modulation input signal to the HP 8341A. It controls a fast RF modulator which is either full on or full off. The amplitude when on is controlled by the linear modulator used for CW leveling and AM. Trace 2 is the resultant RF pulse, which is the HP 8341A's output. This pulse is detected by the crystal detector. It trails the pulse input by 55 nsec, representing propagation delays in the pulse modulator and its drive circuits.

The output of the crystal detector is amplified by a logarithmic amplifier (log amp). The log amp is used for several reasons, one of which is its high gain for small signals, reducing the effects of sample and hold errors. Trace 3 is the output of the log amp. The delay and relatively slow rise time are caused by the finite bandwidths of the detector and log amp. The pedestal (arrow) represents the RF amplitude. This level is captured for further processing by the sample and hold circuit (S/H), represented by the switch-capacitor combination. Trace 4 shows the signal controlling the switch, which is closed when trace 4 is high.

Trace 4 is timed to coincide with the pedestal of trace 3. This timing is done by circuitry associated with the pulse modulator and is factory adjusted for best coincidence. Since the S/H switch is closed only during trace 3's pedestal, the capacitor charges to a constant dc voltage. This voltage is the same as what comes out of the log amp during CW operation at the same power level. The capacitor is isolated by a buffer to prevent the following circuits from discharging it between pulses. The output of the buffer is compared to the ALC inputs in the same manner as with CW operation.

Figure 3-34 shows a 200 nsec pulse. If the pulse were narrowed to 100 nsec, trace 3 would not quite reach its pedestal before it begins to fall. The result is a dc output from the S/H that is smaller than it would be in CW. The ALC circuits respond by raising the RF output until that voltage is what it should be. This is the reason for poor leveling accuracy with narrow pulses. As the pulses are made narrower, their amplitude grows.

The amount of accuracy degradation as the pulses are narrowed varies with frequency, temperature, and power level. The variation with frequency and temperature is due to detector characteristics and RF envelope shape. The detector has a finite rise time determined by its output resistance and shunt capacitance. At some frequencies there is a slight amount of overshoot on the RF envelope, which tends to charge the shunt capacity faster, resulting in better narrow pulse leveling accuracy. A much more pronounced effect is due to the use of a different detector for frequencies below 2.3 GHz. The low band detector has a higher shunt capacity in order to make it function properly at low frequencies. For operation below 400 MHz, a large amount of additional capacity is switched in, enabling detector operation down to 10 MHz. Trace 3 in Figure 3-34 is representative of operation above 2.3 GHz, where pulse accuracy is within 1.5 dB at 100 nsec. From 0.4 to 2.3 GHz, the slower rise time gives a 1.5 dB specification at 200 nsec width. Operation below 0.4 GHz is not specified, but typically is within 1.5 dB at 2  $\mu$ sec width.

The detector's rise time depends on its output resistance, which drops with increasing temperature. Therefore, the narrow pulse leveling accuracy improves at higher operating temperatures.

Narrow pulse accuracy is also power level dependent. Very high ALC levels reduce the detector's output resistance, improving rise time and therefore accuracy. The rise time of a log amp is dependent on signal level, degrading with small signals. In low band (< 2.3 GHz) the log amp is faster than the detector at any ALC level above -10 dBm, so there is no degradation due to the log amp in any coupled mode operation. In high band, the log amp rise time at ALC = -10 dBm is slow enough to be comparable to the detector rise time. Therefore, as power is decreased, the leveling accuracy slightly degrades (narrow pulse amplitude grows relative to CW).

The leveling specifications apply to coupled operation, with no AM; in other words, ALC > -10 dBm. Using decoupled mode or AM, the ALC level can be driven down to -20 dBm or lower. At -20 dBm, the log amp slows down enough that high band accuracy is typically 1.5 dB at 150 nsec, 3.0 dB at 100 nsec. Decoupled mode can also be used to operate the ALC at high levels and achieve better narrow pulse accuracy.

The above discussion applies to internal leveling only. Externally leveled pulse performance will, of course, depend on the detector, but even with a perfect detector the external leveling circuitry is not as fast. It typically will level pulses as narrow as 1  $\mu$ sec, for detector outputs above -40 dBV. An HP low barrier schottky detector driving 4 feet of 50 $\Omega$  cable will realize this performance, but a point contact type driving 4 feet of cable will slightly degrade performance at 1  $\mu$ sec.

Another type of leveling error arises from long pulse periods (low repetition rates), or more precisely, long off times between pulses. The problem lies in the error detection and modulator drive circuits shown in Figure 3-35. On the left is the comparison point, where the ALC input is compared to the detector output. For this discussion assume the two resistors are equal in value, so if the ALC and detector voltages are equal in magnitude but opposite in polarity, the error signal will be zero. The error is fed to an integrator through the integrate/hold switch. This switch is closed continuously during CW operation. Any error signal causes the integrator output to change at a controlled rate (determined by capacitor C), changing the RF output via the linear modulator. The integrator output continues to change until its input is zero, which means the detector voltage is balancing the ALC input voltage. The time required to cancel an error is about 70  $\mu$ sec (4  $\mu$ sec with AM on or when sweeping fast, under which conditions a smaller value of C is switched into the circuit).

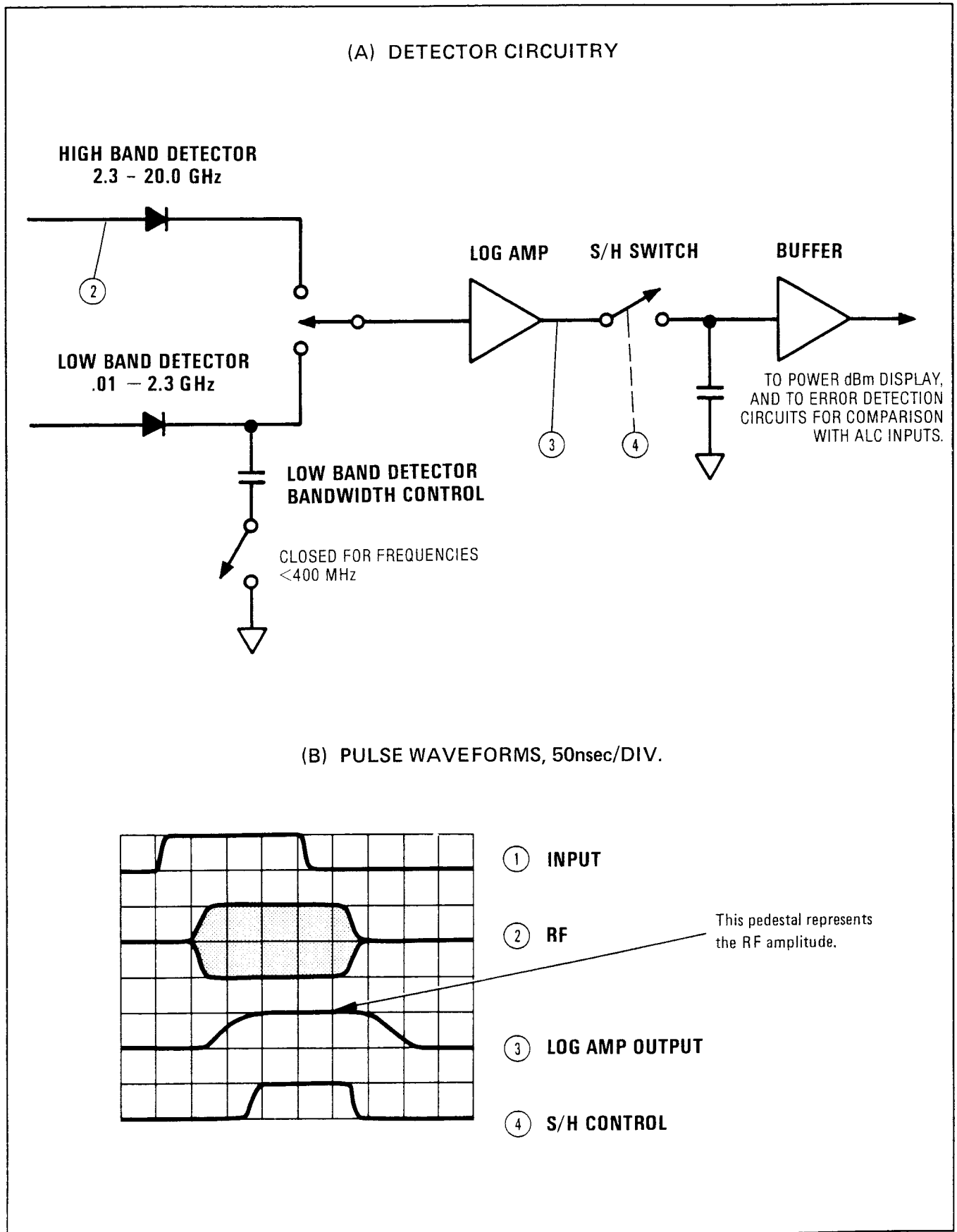

Figure 3-34. Pulse Measuring System

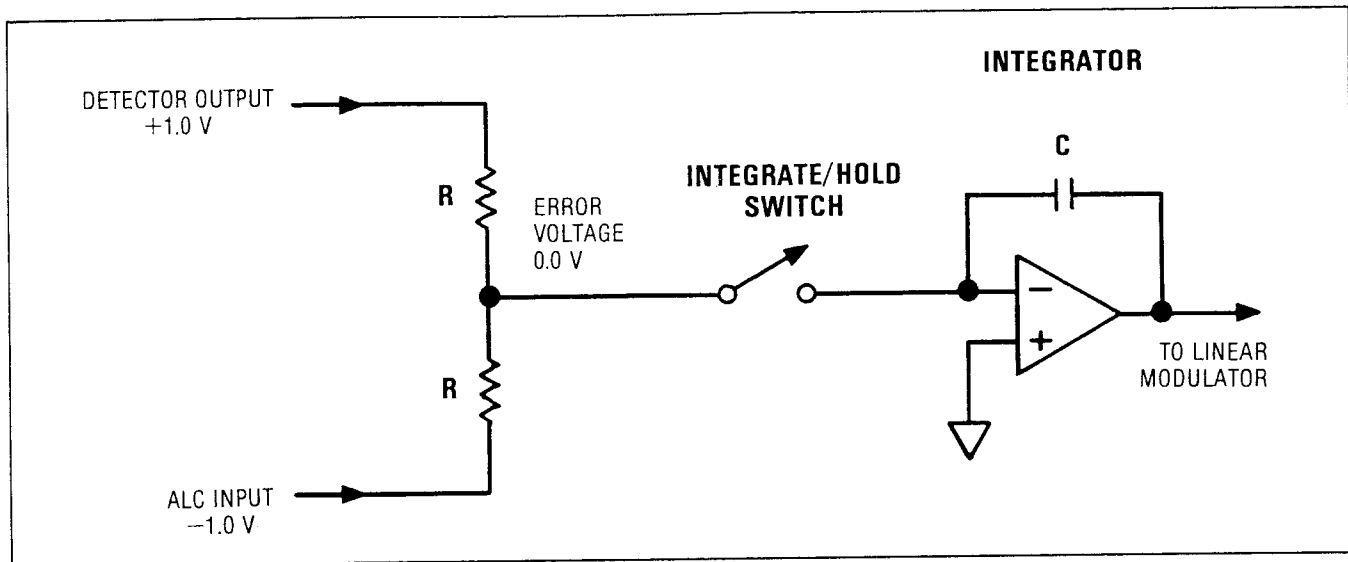

Figure 3-35. Error Detection and Modulator Drive

Consider now pulse operation with a period of 1 msec. The detector S/H measures a pulse and holds its value until the next pulse. Assuming an error is present, the integrator responds to that error, reaching the proper modulator drive in about 40  $\mu$ sec. Since the detector S/H is still holding the error from the last pulse, the integrator keeps changing until the next pulse, overshooting its mark and causing instability. For this reason the integrate/hold switch is only closed during a pulse. During the period between pulses, the switch is opened, thus the integrator input is zero so the modulator drive doesn't change. This assures that the amplitude at the beginning of the next pulse is the same as at the end of the previous pulse. Corrections take place only during the pulses, until equilibrium is reached. Since this may cause very long response times for narrow pulses, the integrate/hold switch is held closed a minimum of 10  $\mu$ sec per pulse, for pulses narrower than that. This is not long enough to cause overcorrections but speeds response time for 100 nsec pulses by a factor of 100.

During the period between pulses, the integrate/hold circuit is expected to hold the modulator drive constant. Because of leakage currents, the output will in fact drift, causing the pulse amplitude to be in error. This error will grow with off time and also temperature, as leakage is strongly temperature dependent. The circuit is designed worst case for < 0.1 dB droop in 10 msec at an ambient temperature of 55° C. At 25° C, a typical unit drifts about 1 dB per minute. The drift may be in either direction.

### Response Time

A tradeoff exists between response time and drift between pulses. Reducing C in Figure 3-35 speeds response to a level change, but also increases drift rate. Some applications require faster response than the HP 8341A's normal operating mode provides. The fast response mode is activated by pressing [SHIFT][AM], which simultaneously turns on AM. This mode is also activated when sweeping with sweep times shorter than 5 seconds. In this mode response is 20 times faster than normal, and worst case droop is 0.2 dB in 1 msec at 55° C.

The response time to a step change in level is a function of pulse width and rate and is detailed in the specifications. The response time is a function of ALC loop bandwidth, which varies with frequency and power as explained in the AM section. The listed response characteristics apply at the minimum expected loop bandwidth. An intuitive feeling for

response may be gained by the following: At minimum bandwidth in CW it takes 70  $\mu$ sec to respond to a change and settle to within 10% of the size of the change. In pulse mode, the same degree of settling requires 70  $\mu$ sec of closure of the integrate/hold switch. This may come from one 70  $\mu$ sec pulse, two 35  $\mu$ sec pulses, etc. Any pulse less than 10  $\mu$ sec wide is treated as a 10  $\mu$ sec pulse. If the pulse period is less than 10  $\mu$ sec, the integrate/hold switch is continuously closed, so the system responds in 70  $\mu$ sec regardless of width or period. In fast response mode the basic time is 4  $\mu$ sec and the minimum integration time is 1  $\mu$ sec.

Simultaneous AM and pulse modulation is provided by the HP 8341A. The AM is dc coupled and linear, just as with normal CW leveling. If AM is used to exercise the ALC below -10 dBm, the narrow pulse leveling accuracy degrades as explained above. The bandwidth is given by the equation:  $3\text{dB BW} = \text{PRF}/20$  (where PRF = pulse repetition frequency). SHIFT AM activates the fast response mode and yields a  $3\text{ dB BW} = \text{PRF}/10$ .

Pulse modulation while sweeping is also possible. The permissible sweep rates are a function of response time, which is a function of pulse width and rate. Sweep times less than 5 seconds activate the fast response mode. The response time should be short compared to the time needed to sweep across each unlevelled ripple. See the sweep speed discussion in the external leveling section. Note: If the start frequency is less than 400 MHz, the low band detector will lock in its low bandwidth state for the entire band 0 portion of the sweep. This effectively precludes leveling pulses narrower than 2  $\mu$ sec.

### Unleveled Mode Used With Pulse Modulation

Decoupled operation may be used for dynamic range extension or any of the other uses described for CW or AM. Several pulse related problems may be treated with the unleveled ([SHIFT] [METER]) operating mode already described.

Narrow pulse leveling accuracy problems may be treated by simply not attempting to level them. The unleveled mode allows the user to control the linear modulator directly. The setting of this modulator does not change with pulse width, so the pulse amplitude remains constant as the pulse is narrowed. Pulses as narrow as 25 nsec may be produced in this mode. To set the amplitude, go to CW operation (pulse off) and set the desired power via the POWER dBm display.

As the pulses are narrowed, the POWER dBm reading drops since it is measuring the output of the detector S/H system and it is the limitations of this system which cause the narrow pulse leveling problems. The real amplitude remains essentially constant, however. In unleveled mode, the POWER dBm display accuracy is the complement of the corresponding leveled pulse accuracy; that is,  $-1.5\text{ dB} + 0.3\text{ dB}$  for width = 100 to 200 nsec, frequency  $\geq 2.3\text{ GHz}$ . If operating close to maximum ALC output there is some amplitude drift (a few tenths of a dB) due to component self-heating when going from 100% duty cycle to low duty cycles.

Since unleveled mode does not involve the integrate/hold circuit, there is no leakage induced amplitude drift between pulses. Consequently, very long periods may be employed that are limited only by the long term drift of the modulator drive circuits. This is not negligible and should be characterized by the user at the frequency of interest. Drifts of a few dB should be expected during warmup. Since this mode is not feedback leveled, the power changes markedly with frequency.

In unleveled mode the ALC inputs control the linear modulator directly, so the response time is not dependent on pulse parameters. The response time is 70  $\mu$ sec maximum in CW, sweeps  $> 5$  seconds, normal AM; or 4  $\mu$ sec maximum for sweeps  $< 5$  seconds or with [SHIFT][AM]. AM works in unleveled mode, but the linearity and sensitivity varies with power level and frequency. See the pertinent preceding section.

### Input Characteristics

When pulse mode is activated, the HP 8341A's RF output is controlled by the voltage at the pulse input. The input circuit is shown in Figure 3-36. The output is off for inputs below approximately +1.5 V. If the input is left open it pulls itself up to +1.8 V, which will turn the output on. The HP 8341A's delay and compression specifications assume an input of 0 to +3.0 V, which requires sinking about 1.6 ma and sourcing about 2.7 ma respectively. The input accepts +12 V to -20 V with no damage, which is compatible with the  $\pm 6$  V modulator drive of certain network analyzers. Aside from small effects on delay and compression, the waveform and amplitude of the input is unimportant, as long as it transitions from +0.5 to +2.5 V in 2  $\mu$ sec or less. This transition is sufficient to generate the fastest rise time. Since the input is not linear, input overshoot will not appear on the output.

Some applications may require a 50 $\Omega$  input. One simple solution is a 50 $\Omega$  feedthrough termination. In the case of special configurations with rear panel inputs, the long length of unterminated internal cable may still cause reflection problems. If so, R14 (circuit board A21) may be replaced with a 50 $\Omega$  resistor. The consequences are that the input no longer pulls up when open, so activating pulse mode with no input will shut off the RF output. With a 1/4 watt resistor the damage level is  $\pm 3.5$  V. A 3/4 watt rating is needed to accept the  $\pm 6$  V drive from certain network analyzers.

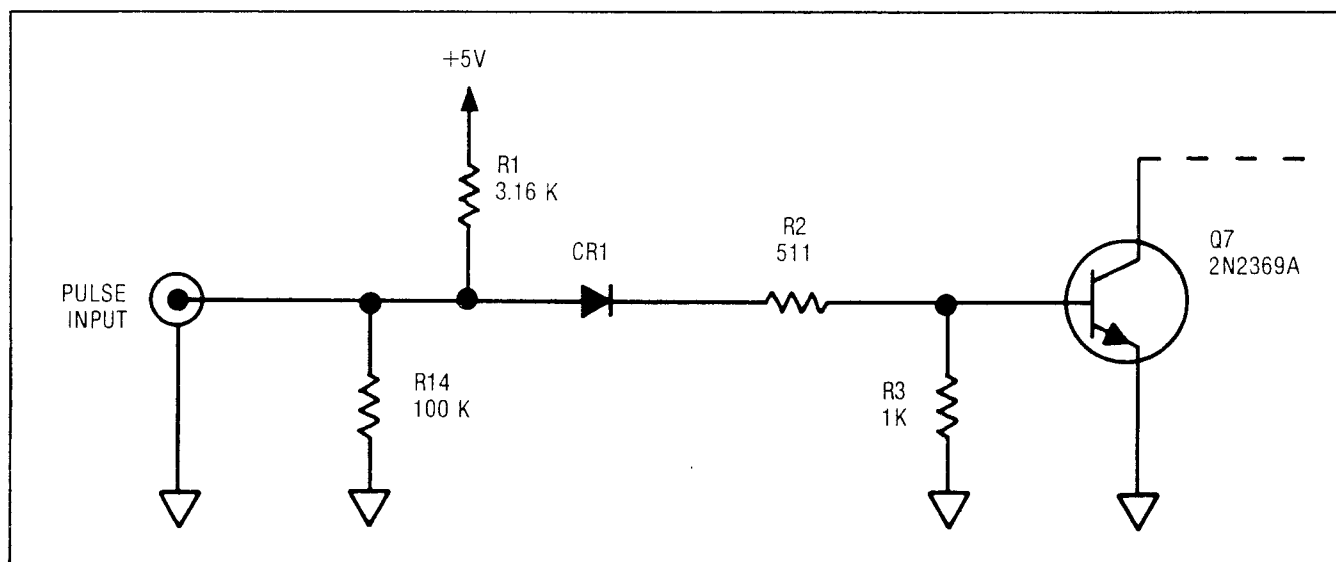

Figure 3-36. Pulse Input Circuit

### Pulse Envelope

The pulse envelope produced by the HP 8341A is not a perfect rectangle, rather it has finite rise time, overshoot, and video feedthrough. Below 2.3 GHz the rise time and overshoot are essentially independent of frequency, but above 2.3 GHz they are strongly influenced by the passband shape and centering of the HP 8341A's tracking YIG filter. Best envelopes are normally obtained by using the PEAK function. The envelopes will change with frequency and slightly with power level.

### Source Match

In the absence of attenuation with a resistive pad, a leveled microwave source generally provides a 50 $\Omega$  source match at its operating frequency only. The source match at other frequencies is that of the unleveled RF hardware. In this case this is a YIG filter which is a

good reflection for anything more than about 20 MHz off center, and not much better within its passband. The match is good only for signals at the output frequency plus or minus the leveling loop bandwidth. Thus a CW reflection will be absorbed. A time varying reflection, as from a reflective modulator, may contain modulation sidebands outside the leveling loop bandwidth. If so, these sidebands may be re-reflected. When pulse modulating, any reflection of the pulse will contain sidebands far outside the loop bandwidth, so the leading edge of the reflection will be re-reflected. In this manner a poorly matched system can generate very poor envelopes (anywhere in the system, not only at the source). Performance is improved by padding between the reflections. At the source, if output powers above  $-10$  dBm are in use, coupled mode results in 0 dB RF attenuation. If enough power is available, decoupled mode may be used to improve the HP 8341A's source match by inserting 10 dB attenuation and using a 10 dB higher ALC level.

### Video Feedthrough

Video feedthrough is a low frequency signal, at the modulation rate, which is superimposed on the RF envelope. See Figure 3-37. If large enough, video feedthrough can disturb mixer balance, amplifier bias, crystal detector output, etc. Since it is low frequency energy, it can disturb systems which are not intended to deal with it, especially demodulation systems.

The HP 8341A's high band ( $> 2.3$  GHz) employs a tracking YIG filter which essentially eliminates video feedthrough. Attempts to measure it can turn out to be measurements of ground currents in coaxial cables. The HP 8341A's low band ( $< 2.3$  GHz) employs a low level mixer followed by a high gain amplifier. At high power levels, the bias levels in the amplifier shift slightly as the RF is turned on or off. The slew of the bias from one level to another couples to the output and produces the video feedthrough waveform. For this reason the 5% specification is only valid for power levels up to  $+8$  dBm. At low ALC levels ( $-10$  dBm), another mechanism predominates. Mixer imbalance produces dc at the output of the mixer, and its magnitude varies with RF amplitude and/or modulator state. This shifting dc level couples through the amplifier, which is AC coupled, and emerges as video feedthrough spikes. In percentage terms this mechanism gets worse at low levels. The lowest percentage video feedthrough is probably found at ALC levels around 0 dBm.

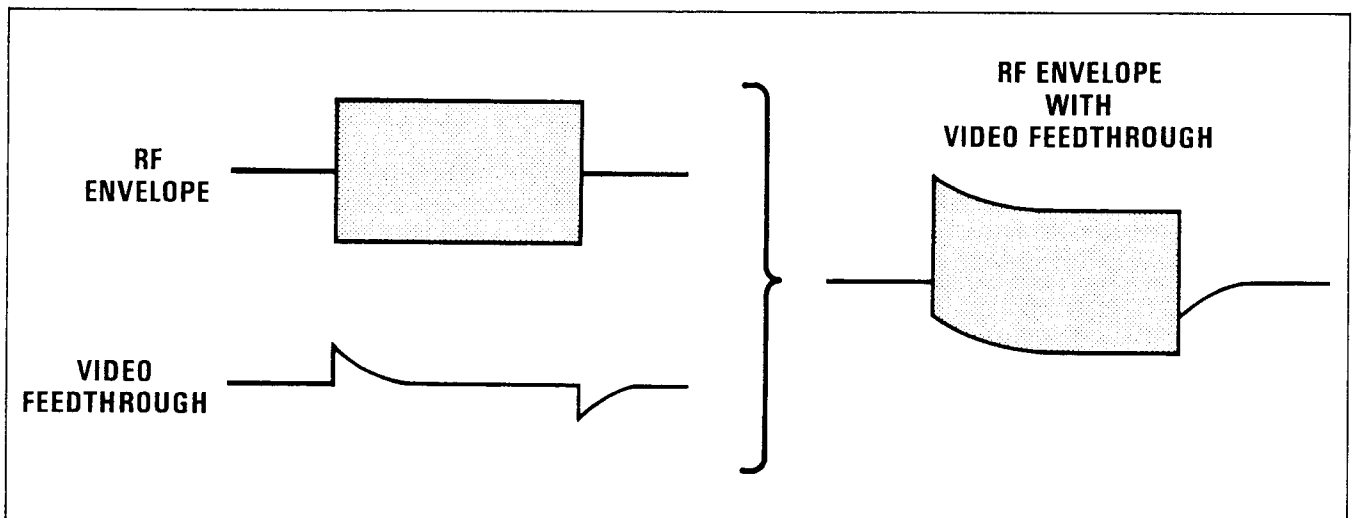
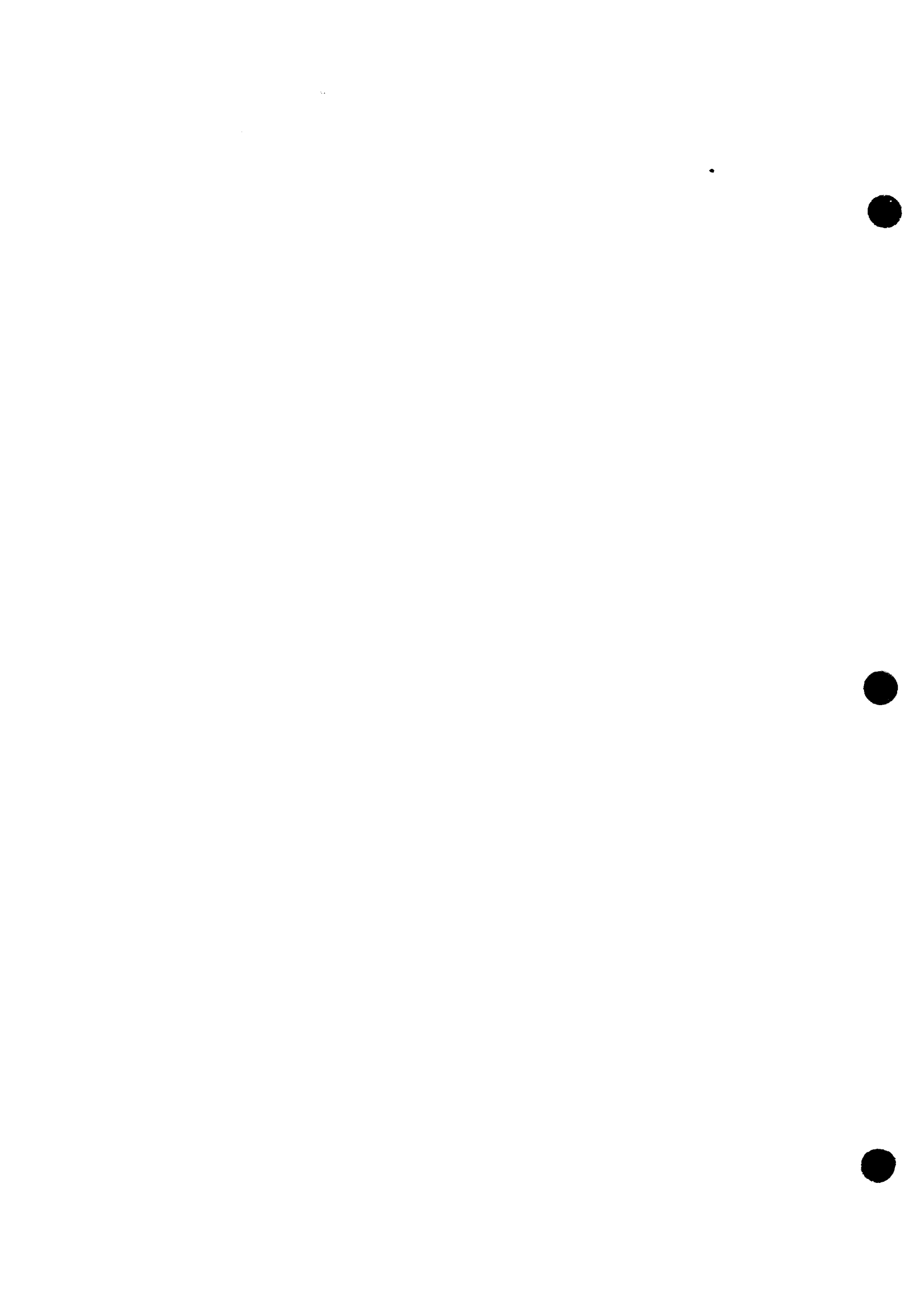

Figure 3-37. Video Feedthrough

### FURTHER INFORMATION

This completes Section III of the HP 8341A Synthesized Sweeper Operating and Service Manual. For further information, there are several Programming Notes, Operating Guides, general-reference Application Notes, and a Manual Changes Supplement that are applicable to the HP 8341A; all of these are available from Hewlett-Packard Sales and Service Offices (listed inside of back cover).





## Externally Leveling the HP 8340A Synthesized Sweeper

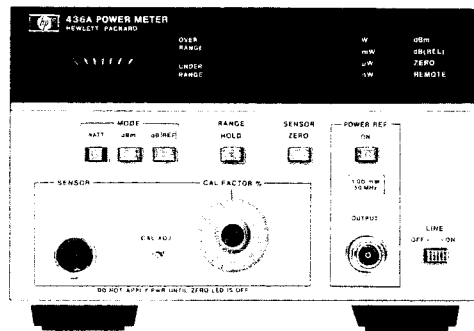

### EXTERNAL LEVELING THE HP 8340A

The output power of the HP 8340A may be externally leveled. A typical setup for external leveling uses either a power splitter or a directional coupler to sample a portion of the RF output signal. This sampled signal is detected to produce a dc voltage proportional to the RF output level. This voltage is compared to a reference voltage in the ALC circuit inside the 8340A to reduce the power level variations over the frequency range. Directional couplers are usually narrowband devices, whereas a power splitter has a flat frequency response over a wide frequency range. The advantage of a directional coupler is that it does not have as great a main line loss as the 6 dB loss incurred when using the power splitter; therefore, a higher maximum leveled power output may be obtained.

### CRYSTAL LEVELING

A listing of crystal detectors, directional detectors, directional couplers, and power splitters that can

be used from 10 MHz to 26.5 GHz is shown in Table 1. Connect the equipment as shown in Figure 1. Then perform the following:

1. Press **INSTR. PRESET** on the 8340A and enter the desired functions (CW or swept mode) and data (desired CW frequency or sweep limits).
2. If a sweep mode is used, set the frequency to the center of the frequency range by pressing the **CW** key and then the appropriate frequency value.
3. Press the **XTAL** leveling key, then use the knob on the 8340A to adjust the REFERENCE level (shown in the ENTRY DISPLAY) for the desired output power reading on the HP 436A Power Meter. (The power meter is used only for accurate setting of the power level and is not otherwise needed for crystal leveling. If a power meter is not available, the leveled output power may be set by observing the POWER dBm display on the 8340A as the REF level is adjusted.

Table 1. Equipment for Crystal Leveling, 0.01 to 26.5 GHz

		FREQUENCY RANGE										
		.01	0.1	1	2	4	8	12	18	20	26.5	
Crystal Detector		HP 8470B (Option 12) — APC 7/N										
		HP 8473B (or HP 33330B) — APC 3.5										
		HP 8473C (or HP 33330C) — APC 3.5						See Note 1				
		J424A		X424A		P424A		K424A				
Power Splitter		HP 11667A (3 Ports — Type N — Female)										
		Weinschel Model 1579 (3 Ports — Type SMA — Female)										
Directional Coupler		778D										
		HP 11691D (or HP 11692D)										
		J752A		X752D		P752D		K752D				
Directional Detector		786D		788C								
		787D		789C								
		J281A		X281C		P281C		K281C				
Adaptors		J281A		X281C		P281C		K281C				

Note 1: —3.5 dB slope between 20 GHz and 26.5 GHz.

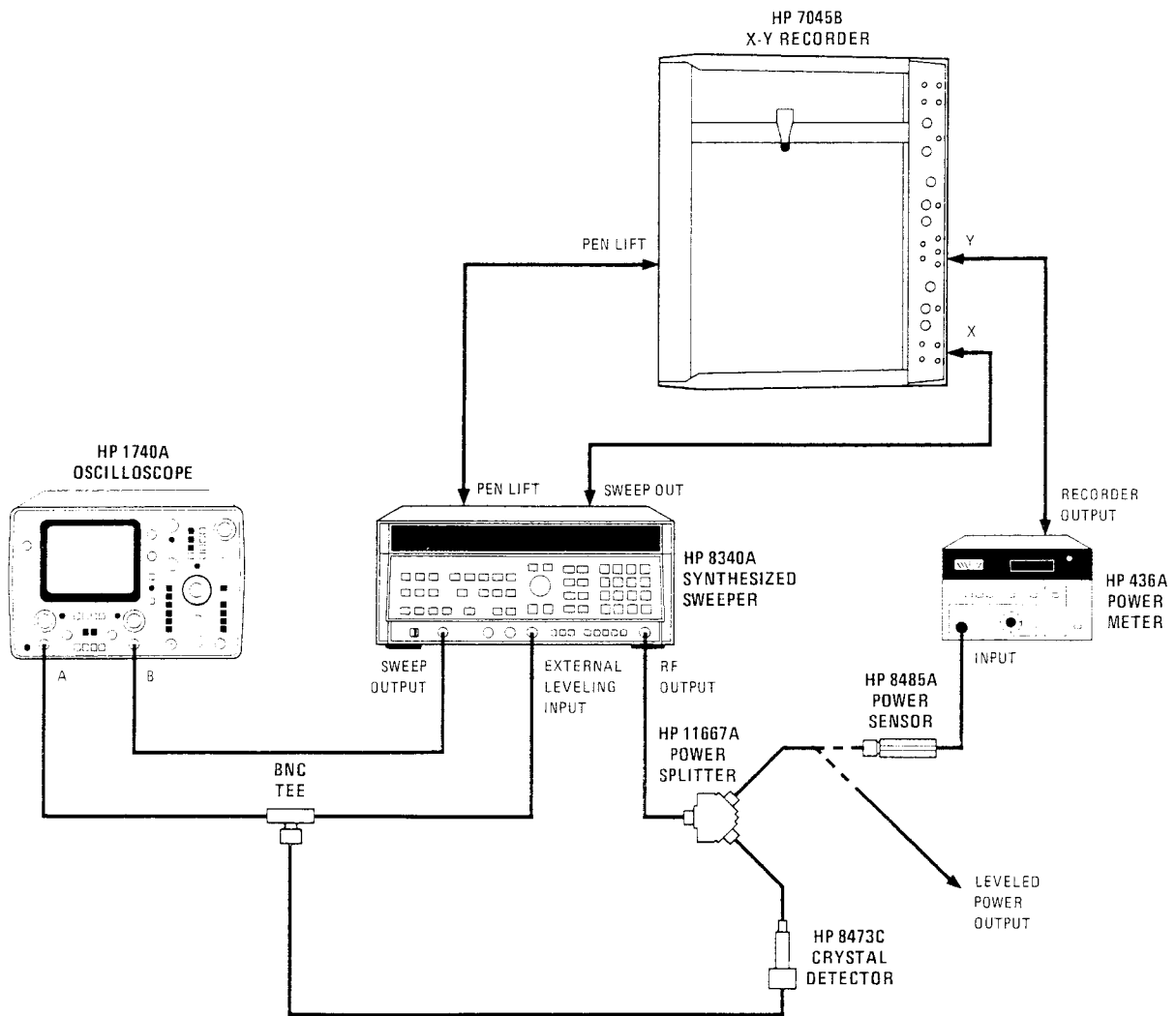

**Note**

1. Using the HP 11667A Power Splitter, APC 3.5 to N (or SMA to N) adapters must be used for the following connections:
 

RF Output .....	APC 3.5 (m)
8473C Crystal Detector .....	APC 3.5 (m)
8485A Power Sensor .....	APC 3.5 (m)
2. The HP 1740A Oscilloscope is placed in A vs B function.

*Figure 1. Typical Equipment Setup for Crystal Leveling*

The POWER dBm reading, minus the 6 dB of loss from the power splitter, gives a very good approximation of the value of the leveled output power.)

#### NOTE

**The crystal output signal must be between 316  $\mu$ V and 3.16 V (-70 dBV to +10 dBV). If desired, the voltage may be checked on an oscilloscope using the setup shown in Figure 1.**

4. Then return to the sweep mode.

If a plot is required, an HP X-Y recorder can be used. (Refer to the "Operation with X-Y Recorders" section of this manual). The recorder output of the 436A Power Meter is used to drive the Y input of the recorder. Due to the slow response of the HP 8485A Thermocouple sensor, a slow sweep speed must be selected during the plot. A minimum sweep time of 50 seconds for a full 10 MHz to 26.5 GHz sweep is recommended.

#### NOTE

**When the 8340A is swept over multiple bands, the RF is momentarily turned off at the band switchpoints. This can create a problem if the 436A is in AUTOSCALE, because the drop in RF power will cause the 436A to switch to a new 10 dB range. Since the RECORDER OUTPUT is 0 to 1 V for each 10 dB range, a range change will cause a spike in the X-Y recorder trace. To avoid this, put the 436A Power Meter in RANGE HOLD.**

### POWER METER LEVELING

All of the HP 432A/B/C, 435B and 436A Power Meters and their corresponding sensors, thermistor mounts or thermocouples can be used for external leveling of the 8340A. Connect the equipment as shown in Figure 2. Equipment recommended for power meter leveling from 10 MHz to 26.5 GHz is shown in Table 2.

Proceed as follows:

1. Press **INSTR PRESET** on the 8340A, then enter the desired functions (CW or swept mode) and data (desired CW frequency or sweep limits).
2. If a sweep mode is used, set the frequency to the center of the frequency range by pressing the **CW** key and then the appropriate frequency value.

3. Then adjust the 8340A power level for the desired power output, reading the power level on either of the 436A power meters.
4. Press **HOLD RANGE** on both 436A Power Meters.
5. Then press **METER** leveling on the 8340A.
6. Then readjust the power level on the 8340A if necessary, by using the knob to adjust the REF level (shown in the ENTRY DISPLAY).
7. Return the 8340A to the sweep mode.

#### NOTE

**This procedure can be shortened by omitting Steps 3 and 4 when using either an HP 432A or an HP 435A Analog Display Power Meter. But when an HP 436A Digital Display Power Meter is used, special care is needed to adjust the power level to the desired value. The reason is that the RECORDER OUTPUT signal from the 436A used to drive ALC loop varies from 0 to 1 V for each 10 dB full scale range on the 436A. The procedure described above presets the power level in the 8340A's INTERNAL leveling mode. Then **HOLD RANGE** is pressed on the power meters to avoid any large variations of the detected power in the ALC loop when the 8340A is set to **METER** leveling.**

Due to the fact that thermistor mounts and thermocouples are very slow-response devices, the 8340A sweep time must be increased to the following recommended values:

Thermocouple (848X):

More than 50 s for full 10 MHz to 26.5 GHz sweep

Thermistor mount:

Typically 50 s for full 10 MHz to 26.5 GHz sweep

If a plot is required, an HP X-Y analog recorder may be used. (Refer to the "Operation with X-Y Recorders" section of this manual). The recorder output of the second 436A Power Meter is used to drive the Y input of the Recorder. Figure 3 shows a typical output power leveling plot from 10 MHz to 26.5 GHz using a 436A Power Meter and an 8485A Power Sensor. The output power is 0 dBm at the 8340A output connector.

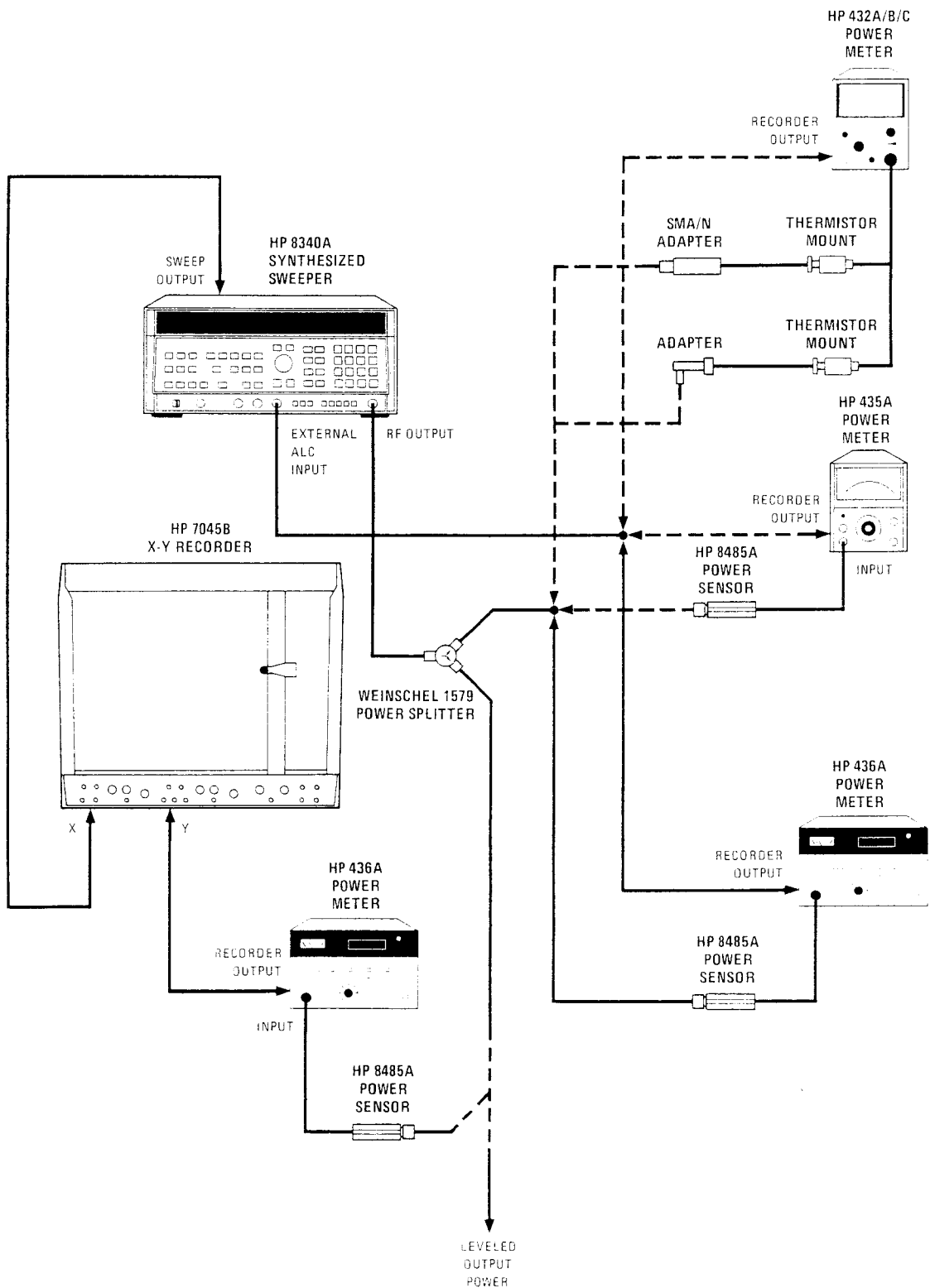
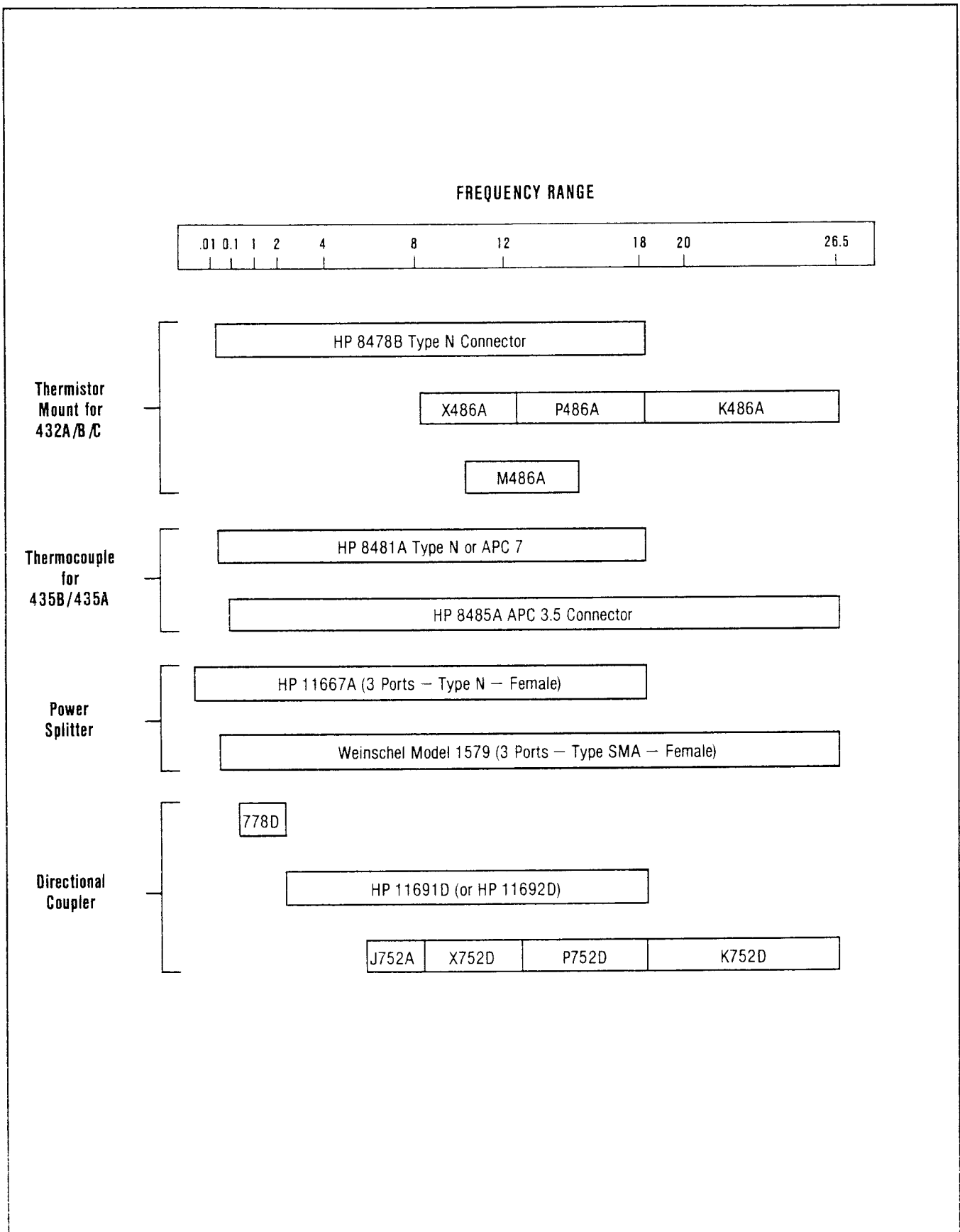

Figure 2. External Power Meter Leveling

Table 2. Equipment for Power Meter Leveling, 0.01 to 26.5 GHz



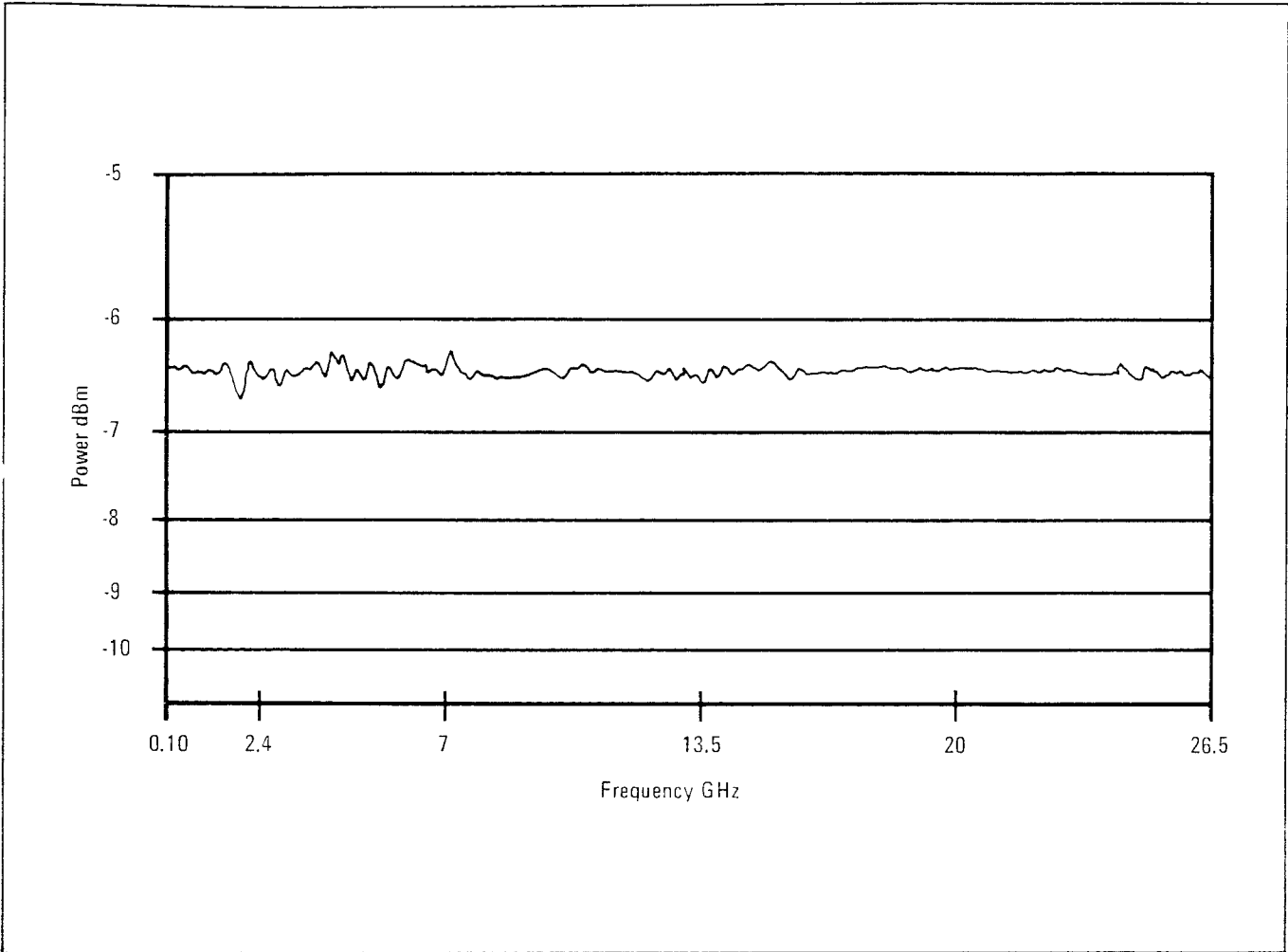
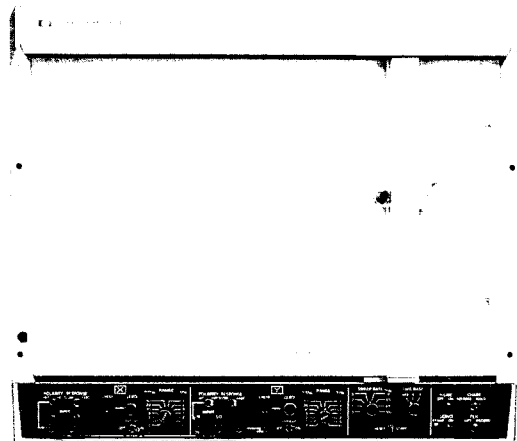

Figure 3. Typical Power Leveling Plot





## Using the HP 8340A Synthesized Sweeper with X-Y Recorders



### X-Y RECORDERS

The HP 8340A is equipped with outputs to control currently existing HP X-Y analog recorders, which are listed below in Table 1. The 8340A must be placed in the **SINGLE SWEEP** mode when used with an X-Y recorder. Various control lines must also be interconnected; these are described below and a typical setup is also shown in Figure 1.

**X-Input:** The X-input to the recorder is generally the **SWEEP OUTPUT** of the 8340A, which is supplied by a BNC connector on both the front and rear panel of the 8340A.

**Y-Input:** The source of the Y-axis voltage to the recorder depends on the equipment being used in the measurement setup. If the 8755S Frequency Response Test Set is being used, the Y-input would be **AUX A** for channel 1 and **AUX B** for channel 2. For 8410B/C systems, the 8412A/B display provides amplitude and phase outputs to the

recorder Y-input via the **AMPTD** and **PHASE** BNC connectors, respectively. If the HP 436A Power Meter is used, its **RECORDER OUTPUT** BNC connector should be used.

Care should be taken to allow the recorder enough time to respond to fine-grain variations in the Y-axis voltage. Recommended 8340A sweep times for each X-Y recorder are given in Table 1.

**Pen Lift:** The **PEN LIFT** control line is assigned to a pin on the remote control connector of the recorder, as shown in Table 1. (For a complete listing of all pin assignments on the remote control connector, refer to the Operating and Service Manual of the recorder being used.) The **PEN LIFT** control line is connected to the **PEN LIFT OUTPUT** BNC connector on the rear panel of the 8340A. **PEN LIFT OUTPUT** is operable only if the 8340A sweep time has been set to a value greater than 5 sec.



Table 1. HP X-Y Recorders

XY Recorder	Mute Function	Mute Function Pin Number	PEN LIFT Pin Number	Ground Pin Number	Recommended Sweep Times
7010B	Std.	A2J2 pin 4 A3J2 pin 4	3	A2J2 pin 6 A3J2 pin 6	≥20 sec.
	Option 002	A4J5 pin L A4J5 pin R		A4J5 pin K A4J5 pin P	
7015B	Std.	A4J5 pin L A4J5 pin R	3	A4J5 pin K A4J5 pin P	≥20 sec.
7035B	N/A	N/A	18	6	≥20 sec.
7004B	N/A	N/A	18	6	≥10 sec.
7034A	N/A	N/A	18	6	≥10 sec.
7040A	Std.	Refer to Section III of the Recorder's Operating and Service Manual.			≥10 sec.
7041A	Option 040	X=pin 5 Y=pin 6	1	3	
7044B	Std.	4	1	20	>10 sec.
7045B	Std.	4	1	20	>10 sec.
7046B	Std.	4	34	19	>10 sec.
7047A	Std.	4	1	20	>10 sec.

**Recorder (Servo) Mute:** When the 8340A is swept over multiple bands, the RF is momentarily turned off at the band switchpoints. To prevent this from causing negative spikes on the X-Y recorder trace, the recorder's servo motor can be muted during the band crossing. The MUTE OUTPUT BNC connector on the rear panel of the 8340A performs this function, and must be connected to both the recorder's X and Y MUTE inputs, the locations of which are shown in Table 1.

As Table 1 also shows, some HP X-Y recorders do not have a MUTE function. When using one of these recorders, the negative spikes at band switchpoints can still be prevented by pressing **SHIFT LINE** on the 8340A front panel. This activates a function which generates a pen lift signal at each band crossing, thus avoiding the spikes. This function is operable only if the 8340A sweep time has been set to a value greater than 5 sec. Once activated, the function is turned off by pressing **SHIFT LINE** again. No change in the pen

lift connections is required to implement this function.

The **SHIFT LINE** function may also be remotely programmed via HP-IB. The programming codes are as follows:

- SHT21 Enable PEN LIFT during band crossing
- SHT20 Disable PEN LIFT during band crossing

As Figure 1 shows, the **SHIFT LINE** function may be used as a substitute for the MUTE function even on those X-Y recorders that do have MUTE capability.

Figure 2 shows a plot of internally leveled output power from the 8340A vs. frequency. The plot was generated on an HP 7045B X-Y recorder. The output power from the 8340A was monitored with an HP 8485A Power Sensor and HP 436A Power Meter, whose RECORDER OUTPUT provided the Y-axis input to the 7045B.

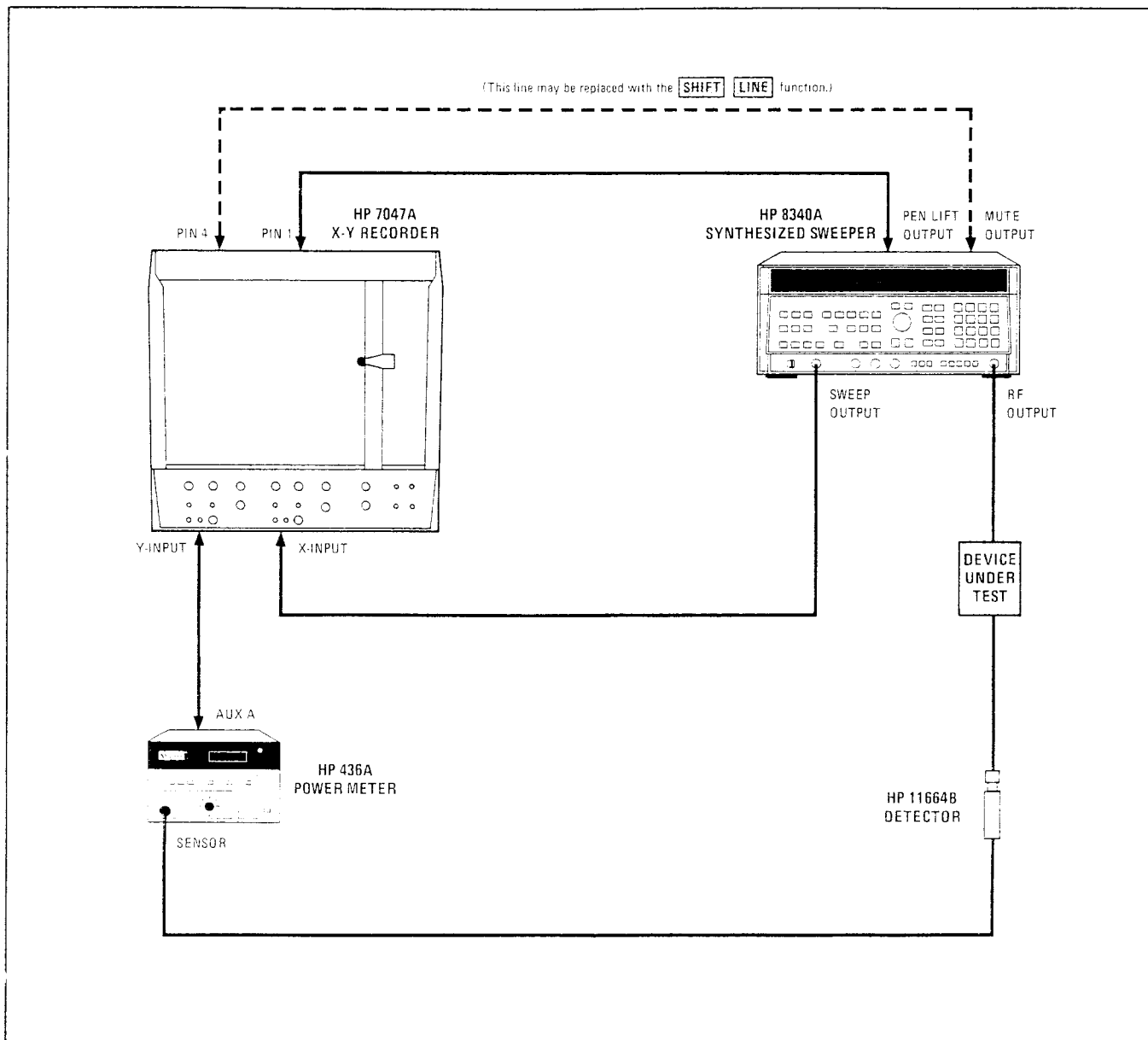

Figure 1. Typical X-Y Recorder Equipment Setup

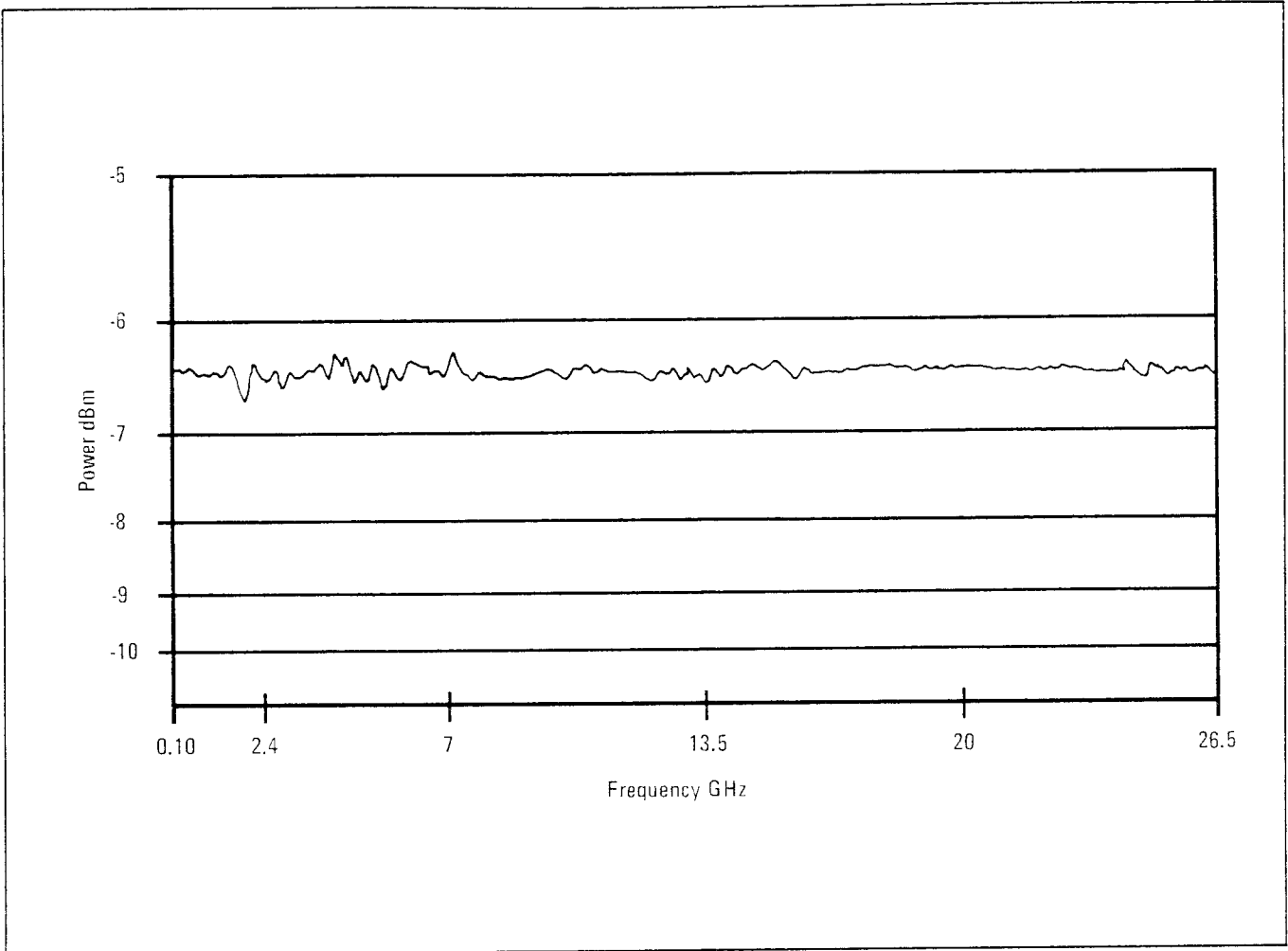
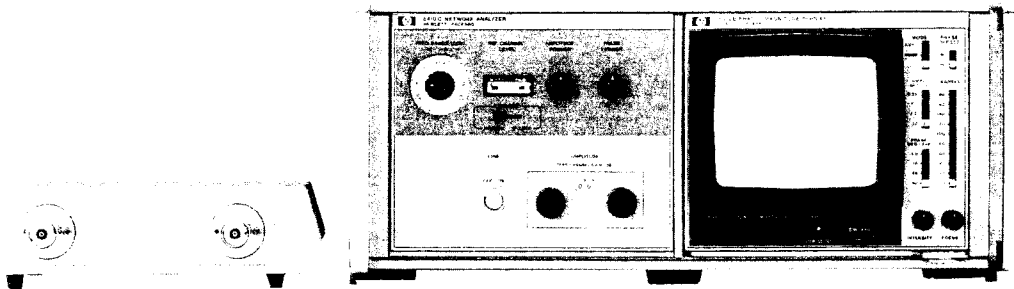

Figure 2. Typical Power Leveling Plot



For more information, call your local HP Sales Office or nearest Regional Office: **Eastern** (201) 265-5000; **Midwestern** (312) 255-9800; **Southern** (404) 955-1500; **Western** (213) 970-7500; **Canadian** (416) 578-9430. Ask the operator for instrument sales. Or write Hewlett-Packard, 1501 Page Mill Road, Palo Alto, CA 94304. In **Europe**: Hewlett-Packard S.A., 7, rue du Bois-du-Lan, P.O. Box, CH 1217 Meyrin 2, Geneva, Switzerland. In **Japan**: Yokozawa-Hewlett-Packard Ltd., 29-21, Takaido-Higashi 3-chome, Suginami-ku, Tokyo 168.

## Using the HP 8340A Synthesized Sweeper with the HP 8410B/C Network Analyzer



### 8410B/C NETWORK ANALYZER

The HP 8340A is compatible with the 8410B/C Network Analyzer systems and accessories. The Source Control Cable (HP P/N 08410-60146) synchronizes the two instruments to provide continuous multi-octave coaxial magnitude and phase measurement capability from 110 MHz to 18 GHz with 65 dB dynamic range. The frequency markers can be displayed in polar format as intensity dots (Z-axis).

Waveguide measurements between 18 and 26.5 GHz can be made with the K8747A Reflection/Transmission Test Unit which is designed for use with the 8410B/C. This test system utilizes two 8340A's, one as a local oscillator and the other to sweep the desired frequency range. If desired, any source covering 18 to 26.5 GHz may be substituted as the L.O.

See Figure 1 for an example measurement setup using the 8410B/C with the 8340A.

The 8410B/C **FREQ RANGE** should be set to **AUTO**. In addition, the sweep time on the 8340A should be slow enough and/or sweep range narrow enough to ensure phase locking of the 8410B/C receiver over the entire sweep range.

Notes on connections:

- 1 V/GHz output of the 8340A provides a frequency reference (**FREQ REF**) to the 8410B/C so that it may synchronize with the sweep.
- The 8410B/C display units (8412B, 8414B) require that the **NEG BLANK** from the 8340A be used as the blanking signal.
- **Z-AXIS BLANK/MKRS** (from the 8340A line) contains the Z axis markers. This line connects to the **MARKERS** input on the 8414B Polar Display and to the **Z AXIS** input on the 8412B Phase-Magnitude Display.

- SWEEP OUTPUT outputs a 0 to +10 volt signal in proportion to the swept or CW frequency output. 0 V corresponds to the lower frequency sweep limit; +10 V to the upper. Swept RF output causes a ramp voltage out; CW output causes a dc voltage out. This connection is necessary only when using the 8412B Phase-Magnitude Display.

- 8340A-8410B/C SOURCE CONTROL CABLE. Provides "handshake" lines for synchronization between the 8340A and 8410B/C (HP Part No. 08410-60146).

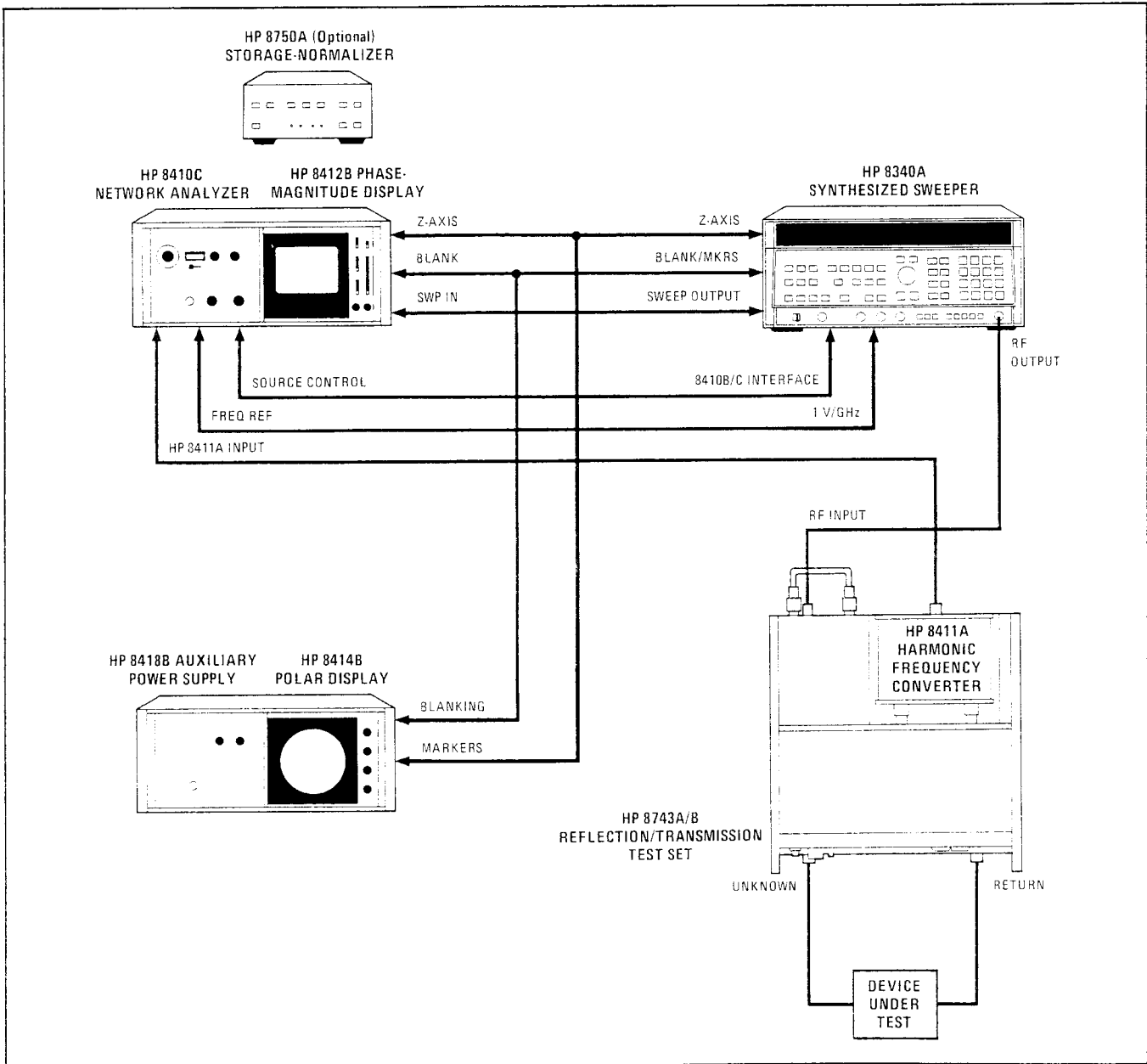
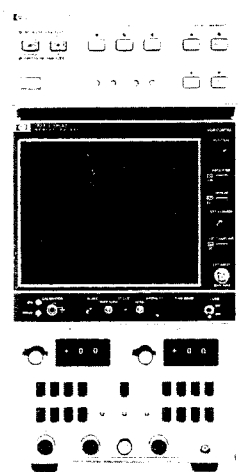

Figure 1. HP 8340A Connections to HP 8410C



For more information, call your local HP Sales Office or nearest Regional Office: **Eastern** (201) 265-5000; **Midwestern** (312) 255-9800; **Southern** (404) 955-1500; **Western** (213) 770-7500; **Canadian** (416) 878-9430. Ask the operator for instrument sales. Or write Hewlett-Packard, 1501 Page Mill Road, Palo Alto, CA 94304. In **Europe**: Hewlett-Packard S.A., 7, rue du Bois-du-Lan, P.O. Box, CH 1217 Meyrin 2, Geneva, Switzerland. In **Japan**: Yokogawa-Hewlett-Packard Ltd., 29-21, Takaido-Higashi 3-chome, Suginami-ku, Tokyo 168.

# Using the HP 8340A Synthesized Sweeper with the HP 8755 Frequency Response Test Set



## 8755S FREQUENCY RESPONSE TEST SET

The 8755S consists of:

- 8755C Swept Amplitude Analyzer
- 182T Display
- 11664A Detectors (3 each)
- 8750A Storage-Normalizer

The 8755S is used for scalar transmission and reflection measurements requiring up to 60 dB of dynamic range and for absolute power measurement from  $-50$  dBm to  $+10$  dBm. The 11664A Detectors supplied with the standard 8755S permit operation from 10 MHz to 18 GHz; operation from 10 MHz to 26.5 GHz may be obtained by using the 8755S Option 005, which substitutes for the 11664A Detectors, three 11664B Detectors which have a frequency range of 10 MHz to 26.5 GHz.

The 8340A has the following features to permit maximum utility with the 8755S Frequency Response Test Set:

**RF Square-wave Modulation.** The 8755C utilizes an AC detection scheme wherein the RF is modulated by a 27.8 KHz square wave. This detection scheme provides excellent stability with time and temperature and allows rejection of unwanted signals that are not modulated. Although the RF can be modulated by an external modulator such as the HP 11665B, this is unnecessary when using the 8340A. All that is required is to connect the MODULATOR DRIVE from the 8755C to the PULSE MODULATION input on the 8340A, and then press **PULSE**.

**"Alternate" Function.** The **ALT** function of the 8340A allows two different front panel settings to be alternated. For example, the front panel setting and the setting stored in a memory register location  $n$  ( $n=1, \dots, 9$ ) can be selected for alternate



sweeps. The Alternate Function will not work properly with the 8755A or 8755B. See Figure 1 for a sweep display of the ALT function when used to view a bandpass response at different resolutions and offsets. Also see Figure 2 for an example of how an alternate sweep is set up.

**Marker  $\Delta$**  The MKR  $\Delta$  function is useful when using alternate sweep in overlapping different sweep widths. The overlapping portion of one of the sweeps can have an increased intensity. The 8750A Storage-Normalizer will need to be in **BYPASS** mode to view Z-axis modulation on the 182T Display.

**Power Sweep.** The RF output power may be ramped up by using the POWER SWEEP function. See Figure 3 for a gain compression display using power sweep.

**Save and Recall.** These functions allow the storage and recall of nine complete instrument settings.

Figure 2 outlines the general procedure used in making a scalar transmission and reflection measurement and also shows how to set up an alternate sweep display. The 11666A Reflectometer Bridge is used in this example, but of course other signal separation devices, such as the

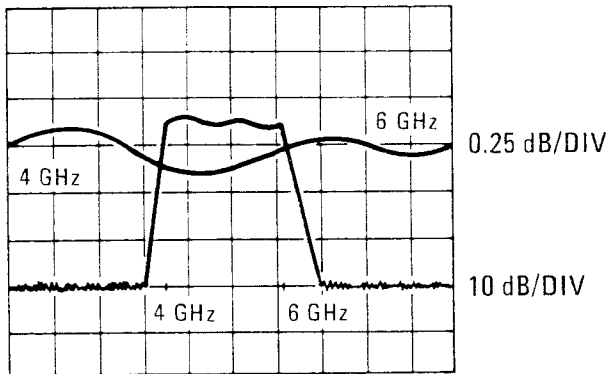

Figure 1. Alternate Sweep Function Display

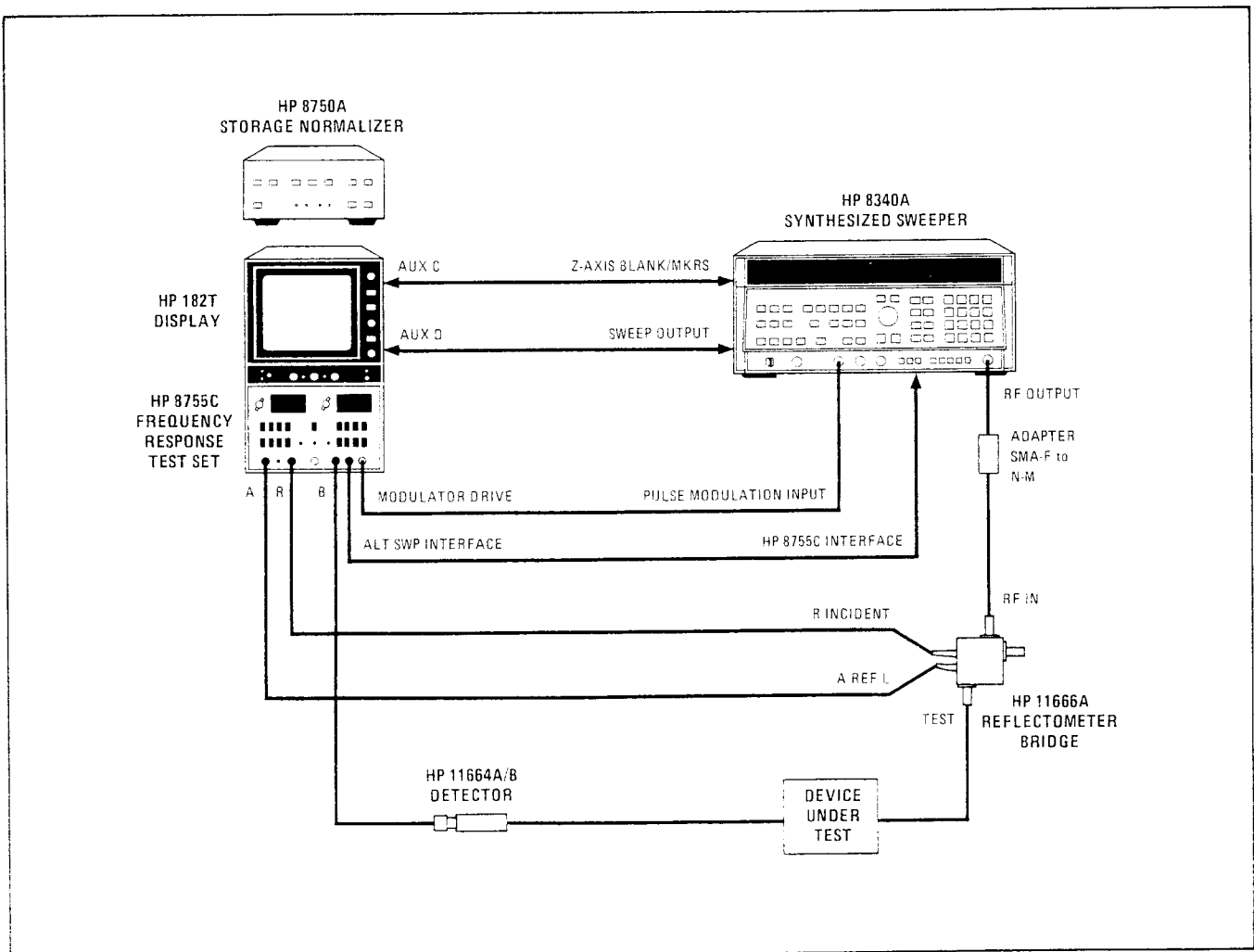

Figure 2. Scalar Transmission and Reflection Measurement



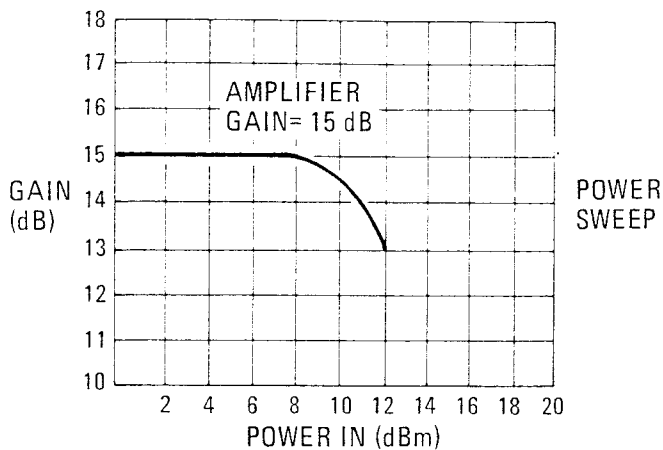

Figure 3. Gain Compression Display

11692D Dual-Directional Coupler, may be substituted. To keep the following procedure brief the 8750A will not be used (switched to **BYPASS**) in the procedure. When using the 8750A with the 8340A Synthesized Sweeper:

- Intensity markers are changed to amplitude markers. In **MKRA** mode they appear as a level shift over the **MKRA** range.
- If an 8755 channel is switched off the trace goes to the reference line (bottom of CRT).

Example:

1. Connect the equipment as shown. Initially, the 8340A should be set by pressing **INSTR PRESET** to set the front panel instrument state and **PULSE** to enable the square wave modulation. Notes on connections:

- Either the front or rear panel **SWEEP OUTPUT** may be used.
  - When in **ALT** mode both channels 1 and 2 (on 8755C) must be on and receiving inputs.
2. Turn off channel 1 on the 8755C by simultaneously releasing all of the channel 1 display pushbuttons. Set the 8340A controls as desired. On channel 2 of the 8755C set the function, dB/DIV and Offset desired for viewing the current sweep setting.
  3. Set the 8340A controls as desired then store the current 8340A sweep setting in any available memory location. Then turn off channel 2 by releasing its display pushbuttons.
  4. Turn on channel 1 of the 8755C and set the function, dB/DIV and Offset as desired. Set 8340A controls as desired.
  5. Turn on channel 2. Press **ALT** and the 8340A will alternate between the two settings on successive sweeps.

Channel 1 now displays the response due to the current front panel setting while channel 2 displays the response to the setting stored in memory location n. (If it is desired to alternate with a memory location other than the one just stored, press the number of that location on the 8340A numeric keypad.) The front panel controls of the 8340A are enabled and the current sweep setting may be altered if desired.



TE  
I

# ING SPEED SWEEPER

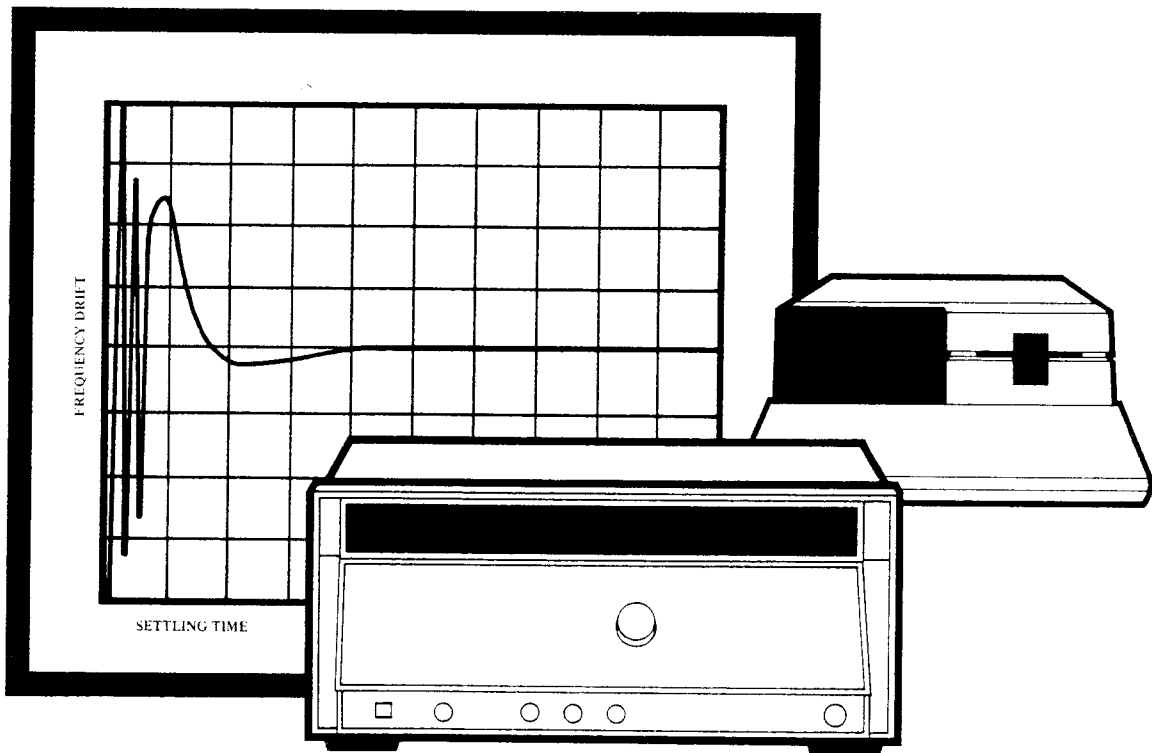

## INTRODUCTION

The increased need in automatic test systems for performance characterization of complex equipment requires fast measurement capability and repeatability. In order to provide dynamic test conditions for these systems, the test source must often settle to a new frequency within a few milliseconds.

The HP 8340A Synthesized Sweeper, for example, specifies its frequency switching time to be less than 50 ms across its broad 10 MHz to 26.5 GHz frequency range. However, if greater switching speed is necessary, one can utilize a few existing HP-IB (Hewlett-Packard Interface Bus) commands and programming techniques to achieve up to four times the specified speed.

This product note addresses the 8340A Synthesized Sweeper's definition of specified switching time, and explains the techniques available to improve its switching time, with sample programs written for the HP 200 series (9816A, 9826A, 9836A) controllers.

### WHAT IS SWITCHING TIME?

The HP 8340A Synthesized Sweeper's switching time is defined to be the time between programming two frequencies via HP-IB not including the HP-IB character processing times. The total switching time consists of three overlapping components: processor time, lock time, and settling time. The processor time is the time the 8340A takes to program the hardware to a given frequency. The lock time is defined as the time required for the 8340A to tune and phase lock to the new frequency. Once the lock has occurred, there is still a finite phase error in the phase-locked loops to be settled to a steady state. The time it takes for the 8340A to settle to within a given resolution of the final output frequency is called the settling time. In the 8340A, the processor time and the settling time are constant. However, the lock time depends on the size of the frequency change, and the value of the 8340A output frequency. The specified switching time of the 8340A is the worst case time, and it is measured using the worst case step size and the **UP** and **DN** commands. The 8340A's typical frequency switching time is measured at 45 ms.

For efficient use of system time, one should make sure there are no extraneous carriage returns or line feeds after an instruction so that the interface bus will be released to process other instrument (e.g. HP 8566A Spectrum Analyzer) commands while the 8340A is busy. The use of ";" after an instruction suppresses both the carriage return and the line feed which are normally output to the 8340A after the last terminator.

The following sample program shows the use of **UP** commands and ";":

```
10 OUTPUT 719; "IP PM1 CW"; F; "GZ";  
20 OUTPUT 719; "SF"; S; "KZ";  
30 OUTPUT 719; "CW";  
40 FOR I=1 TO 100  
50 OUTPUT 719; "UP";  
60 NEXT I  
70 END
```

### IMPROVING THE SWITCHING TIME

One can improve the 8340A switching time by using a few HP-IB only commands that are implemented in the 8340A.

The **IF** command increments the frequency by the specified step size. This command performs the same function as the **UP** command, however, when the 8340A receives an **IF** command it does not update the frequency displayed in the ENTRY DISPLAY (as does the **UP**), thus saving time. This command is functional in the normal mode or the Fixed Points mode (the **SN** command) of the Manual Sweep or in the normal mode of CW operation. (In the Fixed Points mode of Manual Sweep using the **SN** command, one can specify the number of steps desired between the given start and stop frequencies. The minimum and maximum number of these steps are 10 and 1000, respectively.)

The most significant advantage of the **IF** command is that it reduces typical switching time to 25 ms. The disadvantages are that the **IF** command cannot be used to cause random step sizes and that it will not update the **ENTRY DISPLAY**. However, for most applications, as in automatic test systems, discrete steps are more desirable. In addition, if the 8340A display was active it would be changing too fast to be readable.

The following sample programs show how the **IF** command can be used to increment a frequency by the specified step size in both the Manual Sweep and the CW modes.

#### The Normal Mode of Manual Sweep:

```
10 OUTPUT 719;"IP PM1 FA";A;"GZ FB";B;"GZ"
20 OUTPUT 719;"SF"; S; "KZ"
30 OUTPUT 719;"S3"; A; "GZ"
40 FOR I=1 TO 100
50 OUTPUT 719;"IF";
60 NEXT I
70 END
```

#### The Fixed Points Mode of Manual Sweep:

Delete line 30 and modify lines 20 and 40 to,

```
20 OUTPUT 719;"SN"; N
40 FOR I=1 TO N
```

#### The Normal Mode of CW:

Modify lines 10-30 to,

```
10 OUTPUT 719;"IP PM1 CW"; F; "GZ"
20 OUTPUT 719;"SF"; S; "KZ"
30 OUTPUT 719;"CW"
```

#### TRIGGER 719

The command **TRIGGER 719** (where 719 is the HP-IB address of the 8340A), triggers the 8340A to increment to a new frequency by the specified step size. This command is functional in either the normal or the Fixed Points mode (the **SN** command) of the Manual Sweep, or the normal or Fast Phase-lock mode (the **FP** command) of CW operation (For more information on the **FP** command refer to the section on **FP** that follows.) The advantages of the **TRIGGER 719** command are typical switching time of 25 ms in the Fixed Points Manual Sweep mode, and less than 25 ms to be within approximately 1 kHz of the final frequency in the Fast Phase Lock mode.

The following sample programs show how the **TRIGGER 719** command is used in both the Fixed Points mode of Manual Sweep and the Fast Phase Lock mode of CW operation.

#### The Fixed Points Mode of Manual Sweep:

```
10 OUTPUT 719;"IP PM1 FA";A;"GZ FB";B;"GZ"
20 OUTPUT 719;"SN"; N
30 FOR I=1 TO N
40 TRIGGER 719;
50 NEXT I
60 END
```

#### The Fast Phase Lock Mode of CW:

```
10 OUTPUT 719;"IP PM1 CW"
20 OUTPUT 719;"SF"; S; "KZ"
30 OUTPUT 719;"FP2,3E9"
40 WAIT 0.016
50 FOR I = 1 TO 100
60 TRIGGER 719
70 WAIT 0.016
80 NEXT I
90 END
```

The previously mentioned **FP** or Fast Phase-Lock command is functional only in the CW mode. Fast Phase-lock, is used when the fastest possible frequency transition is necessary between CW frequencies. **FP** can be used for fast transitions between steps in a stepped CW sweep, or it can be used when the CW frequencies must be rapidly changed to any value in the 10 MHz to 26.5 GHz frequency span of the HP 8340A.

**FP** achieves rapid frequency transition by limiting some of the normal HP 8340A features: the plotter control functions are disabled, the 0-10 volt sweep ramp is frozen, and the HP 8340A does not wait for a complete locking of the phase lock loop oscillators before releasing the HP-IB handshake. The **FP** code must have a numerical suffix (14 characters maximum) in Hz units, without any terminator code (ASCII LF, normally sent by the computer, is the only allowable terminator), that sets the starting frequency. Leading spaces and terminations (e.g. HZ or ";") are ignored. Avoid using a ";" after a numeric entry when using the **FP** command as it suppresses both the Carriage Return and the Line Feed output by a controller. For example, one can program a frequency of 2.3 GHz as follows:

- (1) OUTPUT 719; "FP2.3E9"
- (2) OUTPUT 719; "FP2300000000"

Variables can be used to represent the frequency after an **FP** command as follows:

- (3) OUTPUT 719; "FP";A

However, the same limitations (i.e. frequencies in units of hertz, and 14 characters limitation) as above apply. A format or an image statement in the program may be used to assure the correct representation of the frequency.

When the 8340A receives a **FP** command, it processes the characters and numbers in less than 6 ms and then releases the HP-IB handshake. Thus, the hardware settling time (Lock time + Settling time) will have to be programmed by the user via a **WAIT** statement to guarantee a phase locked frequency. For example, if you program a random step size and cover the total range of the 8340A, a **WAIT** time of 16 ms will typically be sufficient to guarantee phase-locked frequencies. However, if other components of the measurement system (e.t. the HP 8566A Spectrum Analyzer) are programmed in parallel to the 8340A, programming a **WAIT** statement may not be necessary, since the process time of another instrument may allow enough time for the 8340A to reach a synthesized frequency.

The worst-case **WAIT** time of 16 ms covers random step sizes. However, when an application calls for discrete step sizes of less than 1 GHz, the **WAIT** times can be reduced. Some 8340A's were characterized to determine the hardware settling times (**WAIT** times) needed for the frequency to settle within 1 kHz of its final value for various frequency step sizes. The results are shown in TABLE 1 below. For instance, if the user does not cross a band switchpoint and takes 200 MHz steps, the hardware settling time is typically 5 ms, which, when added to the 6 ms of processor time, gives a total typical switching time of 12 ms.

FREQUENCY STEP SIZE	FREQUENCY SPAN	TYPICAL HARDWARE SETTLING TIMES (OR <b>WAIT</b> TIMES)	TYPICAL TOTAL SWITCHING TIMES (TO BE WITHIN 1 kHz OF FINAL FREQUENCY)
1 GHz	Within bands <sup>1</sup> (without crossing bandswitch points)	10 ms	16 ms
500 MHz		12 ms	18 ms
200 MHz		6 ms	12 ms
100 MHz		11 ms	17 ms
10 MHz	190 MHz and within bands <sup>1</sup>	5 ms	11 ms
5 MHz		9 ms	15 ms
2 MHz		8 ms	14 ms
1 MHz		5 ms	11 ms
<1 MHz		<5 ms	<11 ms
Random Step Size	Within the whole range of 8340A 0.01 to 26.5 GHz	16 ms	22 ms

TABLE 1. Typical Step Sizes and Hardware Settling Times or **WAIT** Times.

<sup>1</sup> Bands are:  
0.01 to <2.3 GHz  
2.3 to <7.0 GHz  
7.0 to <13.5 GHz  
13.5 to <20.0 GHz  
20.0 to <26.5 GHz

The HP 8340A is both a high performance broadband synthesizer and a broadband sweeper, and is thus a valuable component of automatic test systems. Its broadband analog sweep capability can be used for faster and more thorough characterization than is possible from a digitally stepped sweep. If, however, point to point information is needed, the 8340A's frequency accuracy and programmability, combined with the improved switching speed techniques described in this note, will provide a fast and repeatable stimulus.

For easy reference, the following table (TABLE 2) summarizes the different techniques and resulting switching times.

		CW <sup>1</sup>	
STEP SIZE	COMMANDS	NORMAL MODE (frequency specified in any format)	FAST PHASE-LOCK MODE (frequency specified in exponents or hertz format)
RANDOM STEP SIZE		OUTPUT 719;"CW";F;"GZ"  Typically 45 ms	OUTPUT 719;"CW" OUTPUT 719;"FP";F;"HZ" WAIT 16 <sup>1</sup>  Typically 22 ms
SEQUENTIAL STEP SIZE	UP & DN	OUTPUT 719;"CW";F;"GZ" OUTPUT 719;"SF";S;"GZ" OUTPUT 719;"CW" FOR/NEXT loop to increment frequency  Typically 45 ms	N/A
	IF	OUTPUT 719;"CW";F;"GZ" OUTPUT 719;"SF";S;"GZ" OUTPUT 719;"CW" FOR/NEXT loop to increment frequency  Typically 25 ms	N/A
	TRIGGER 719	OUTPUT 719;"CW";F;"GZ" OUTPUT 719;"SF";S;"GZ" OUTPUT 719;"CW" FOR/NEXT loop to increment frequency  Typically 25 ms	OUTPUT 719;"CW SF";S;"GZ" OUTPUT 719;"FP";A WAIT X <sup>1</sup> (where X is time in milliseconds) FOR/NEXT loop to increment frequency including a WAIT time of X milliseconds  Typically <22 ms

TABLE 2. Comparison of Commands and Resulting Switching Times

<sup>1</sup> For complete information on the various commands and programming refer to the respective sections.



**MANUAL SWEEP <sup>1</sup>**

NORMAL MODE (frequency specified in any format)	FIXED POINTS MODE (specify number of steps desired)
<p>OUTPUT 719;"S3";F;"GZ"</p> <p>Typically 45 ms</p>	N/A
<p>OUTPUT 719;"FA";A;"GZ" OUTPUT 719;"FB";B;"GZ" OUTPUT 719;"SF";S;"GZ"; Output 719;"S3";A;"GZ" FOR/NEXT loop to increment frequency</p> <p>Typically 35 ms</p>	N/A
<p>OUTPUT 719;"FA";A;"GZ" OUTPUT 719;"FB";B;"GZ" OUTPUT 719;"SF";S;"GZ" OUTPUT 719;"S3";A;"GZ" FOR/NEXT loop to increment frequency</p> <p>Typically 25 ms</p>	<p>OUTPUT 719;"FA";A;"GZ" OUTPUT 719;"FB";B;"GZ" OUTPUT 719;"SN";N (where 10&lt;N&lt;1000) FOR/NEXT loop to implement frequency</p> <p>Typically 25 ms</p>
<p>OUTPUT 719;"FA";A;"GZ" OUTPUT 719;"FB";B;"GZ" OUTPUT 719;"SF";S;"GZ" OUTPUT 719;"S3";A;"GZ" FOR/NEXT loop to increment frequency</p> <p>Typically 25 ms</p>	<p>OUTPUT 719;"FA";A;"GZ" OUTPUT 719;"FB";B;"GZ" OUTPUT 719;"SN";N (where 10&lt;N&lt;1000) FOR/NEXT loop to increment frequency</p> <p>Typically 25 ms</p>



## HP 8340A PRODUCT NOTES

Contact the nearest Hewlett-Packard Sales and Service Office for other Product Notes. A list of available Product Notes is shown below:

Product Note	Title	HP Part Number
8340A-2	Not Assigned	
8340A-3	Not Assigned	
8340A-4	Not Assigned	
8340A-5	<i>60 GHz FREQUENCY COVERAGE USING THE HP 8340A SYNTHESIZED SWEEPER AND THE WJ 1204-4X FREQUENCY EXTENDER</i>	5952-9346
8340A-6	<i>REDUCED HARMONIC DISTORTION USING THE INTEGRA TMF-1800H TRACKING FILTER WITH THE HP 8340A SYNTHESIZED SWEEPER</i>	5952-9343
8340A-7	<i>MICROWAVE NOISE FIGURE MEASUREMENTS USING THE HP 8340A SYNTHESIZED SWEEPER WITH THE HP 8970A NOISE FIGURE METER</i>	5953-8879



# HP-IB Programming Note



## Introductory Operating Guide

For the HP 8340A/8341A synthesized sweepers with the HP 9000 Series 200/300 desktop computers (BASIC)

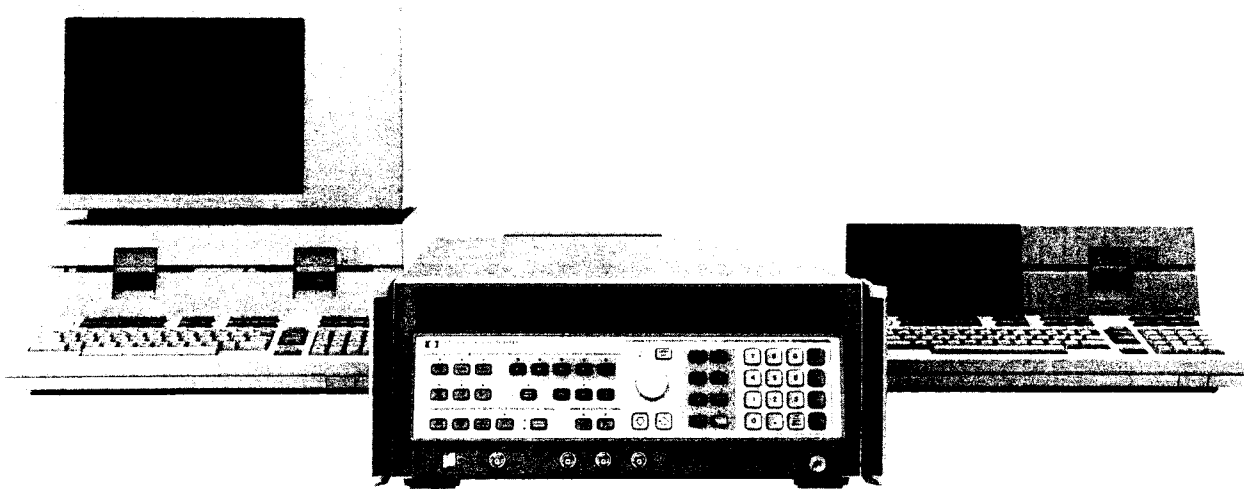

## Introduction

This programming note is a guide to the remote operation of the HP 8340A and 8341A synthesized sweepers. Included in this guide are the system connections for remote operation and sample programs that demonstrate the capabilities of the HP 8340A/8341A and provide a starting point for those who want to create programs tailored to their specific measurement needs.

The HP 8340A/8341A are fully programmable synthesized sweepers compatible with the Hewlett-Packard Interface Bus (HP-IB). When used with a controller such as the HP 9826A or HP 98580A, complete control of the synthesized CW frequency, sweep mode, frequency limits, frequency markers, power level, modulation, and all other front panel controls can be achieved.

This note demonstrates the HP-IB control of the HP 8340A/8341A via the BASIC 4.0 Programming language system. For clarity, only the HP 9826A/8340A combination is referenced in the sample program explanations, although all the sample programs will run with any combination of controller and synthesized sweeper. Your particular HP 8340A or 8341A option configuration may affect the operation of some programs.

## Reference Information

For further information on the HP Interface Bus, the following should prove helpful:

Tutorial Description of the Hewlett-Packard Interface Bus (HP Lit. No. 5952-0156)

Condensed Description of the Hewlett-Packard Interface Bus (HP Lit. No. 59401-90030)

Complete reference information on the HP 8340A and 8341A synthesized sweepers can be found in the HP 8340A or 8341A Operating and Service Manual (HP Part No. 08340-90020 or 08341-90001) and HP 8340A Quick Reference Guide (HP Part No. 5953-8877).

For information on operating the HP 9000 Series 200/300 computers, the following references are available:

BASIC 4.0	
Programming Techniques	(HP Part No. 98613-90011)
Interfacing Techniques	(HP Part No. 98613-90021)
Users Guide	(HP Part No. 98613-90041)
Language Reference	(HP Part No. 98613-90051)

## Equipment Required

To perform all the example programs as described in this programming note, you will need the following equipment and accessories:

- HP 8340A or 8341A synthesized sweeper
- HP 9000 Series 200 computer  
(for example the HP 9826A) with BASIC 2.0, 3.0, or 4.0 with at least 64K bytes of free user memory.
- OR
- HP 9000 Series 300 computer  
(for example the HP 98580A) with at least 64K bytes of free user memory.
- HP 2225A thinkjet printer (for hard copy output)
- Two HP-IB cables (HP 10833A/B/C/D)

### NOTE

The following equipment will provide a visual display of the HP 8340A functions, but it is not required for the programs to run.

- HP 8757A scalar network analyzer
- HP 11664E (AC) or HP 85025B (AC/DC) detector
- Four 120 centimeter BNC cables (HP 11170C variety)

### NOTE

The HP 8757A may be replaced by the HP 8756A or by any appropriate oscilloscope with crystal/Schottky Detector, attenuator, and BNC cabling.

- HP 8566B spectrum analyzer with 10833A/B/C/D HP-IB Cable
- HP 3312A function generator (or equivalent)
- HP 8011A pulse generator (or equivalent)
- Any test device within the frequency range of the HP 8340A (10 MHz to 26.5 GHz) or the 8341A (10 MHz to 20.0 GHz)

## Setup

Figure 1 shows the system connection. All that is required is to:

1. Connect the 24-pin HP-IB connector of the built-in HP-IB interface of the HP 9826A to the printer and the HP 8340A.  
Refer to O/S Manuals for more detail on interconnects.

### CAUTION

**Do not attempt to mate black metric threaded screws on one connector with silver English threaded nuts on another connector, or vice versa, as damage may result. (A metric conversion kit which will convert one cable and one or two instruments to metric hardware is available by ordering HP Part No. 5060-0138.)**

2. Following the instructions in the BASIC Operating Manual for the HP 9826A, load the BASIC language system, if required.
3. The HP-IB select code is assumed to be preset to 7. This programming note assumes the HP-IB address of the HP 2225A graphics printer is 01.

4. All programs within this guide expect the HP 8340A HP-IB address to be decimal 19. The HP 8340A HP-IB address is factory preset to decimal 19.

To find the present HP-IB address use the front panel "Set HP-IB Address" function by pressing:

**[SHIFT] [LOCAL]**

The ENTRY DISPLAY will indicate the present decimal address. If the number displayed is not 19, it may be reset to 19 by pressing:

**19 [GHz]**

The non volatile memory of the HP 8340A will maintain this HP-IB address until another address is entered.

### NOTE

When using an HP 9000 Series 300 computer rather than a Series 200 computer:

1. The **[RETURN]** key on the Series 300 keyboard functions as both the **[ENTER]** and **[EXECUTE]** keys on the Series 200 keyboard.
2. There is no **[EDIT]** key on the Series 300 keyboard, so type in **EDIT** then **[RETURN]**.
3. The **BASIC keyboard overlay on the Series 300 computer provides the location of several keys such as: RESET, CLR SCR, RUN, CONTINUE, PAUSE, etc.**
4. When there is a pause in the program, press either **[CONTINUE]** or **[RETURN]** on the Series 300 computer.

## Check Out

If your computer has a soft-loaded operating system and power has been turned off, the system must be reloaded. To do this insert the BASIC system disc into the disc drive of the computer and turn it on. After a few seconds the computer displays "BASIC Ready x.x", where "x.x" is the BASIC version number (2.0, 3.0 or 4.0). If you are using BASIC 3.0 or 4.0 you will also need to load the HPIB and IO (BIN) programs from the extensions disc via the LOAD BIN command.

Turn on the rest of the equipment. The HP 8340A should undergo a turn-on self test consisting of the red LED numeric displays being blanked and all indicator LED's on. The HP 8340A sweep controls are then set to the instrument preset state: START/STOP sweep internally leveled over the entire frequency range, fastest sweep time, and 0 dBm output power. If the HP 8340A fails the turn-on self test then either the red LED's next to INSTR PRESET key will be on, or the FAULT annunciator will come on. Check section 8 of the HP 8340A Operating and Service manual for error message explanations and diagnostics.

To verify that the HP-IB connections and interface are functional:

1. Press **[SHIFT] [PAUSE]** to reset the HP 9826A
2. Type in **SCRATCH [EXECUTE]** to clear any previous programs in memory
3. Press **[EDIT] [EXECUTE]**, then type in the following program:

```
10 !HPIB TEST
20 S0=719
30 ABORT 7
40 CLEAR S0
50 PRINT "9826A is ACTIVE controller"
60 REMOTE S0
70 DIM A$(1)
80 INPUT "8340A is in REMOTE MODE", A$
90 END
```

When several instruments are connected to the HP Interface Bus, an **ABORT** command abruptly terminates all bus activity and resets all devices on the bus to turn-on states and the HP 9826A recovers the active control of the bus. The **CLEAR** command sets all (or only selected) instruments to a predefined device-dependent state. The **REMOTE** command is used to put all (or selected) instruments into the remote mode.

The **DIM** statement sets the length of the A\$ string to 1 character. This is used for the input statement that pauses the program. The **LINPUT** statement displays a message and then waits for a **[CONTINUE]**, **[ENTER]**, **[EXECUTE]** or **[RETURN]** to resume program execution.

Run the program and verify that the REMOTE light is lit on the HP 8340A. If it is not, verify that the HP 8340A address is set to 19 and that the interface cable is properly connected.

If the HP 9826A display indicates an error message, it is possible that the program was entered in incorrectly. If the HP 9826A accepts the **REMOTE** statement but the HP 8340A REMOTE light does not turn on, perform the operational checks as outlined in the respective Operating and Service Manuals to find the defective device.

All of the HP 8340A functions available through the front panel keys are programmable via HP-IB. When the HP 8340A is in REMOTE mode, all the front panel keys are disabled except the LOCAL key. But, when the **LOCAL LOCKOUT** command is set on the bus, even the LOCAL key is disabled. The **LOCAL** command, executed from the HP 9826A, is then the only way to return all (or selected) instruments to front panel control.

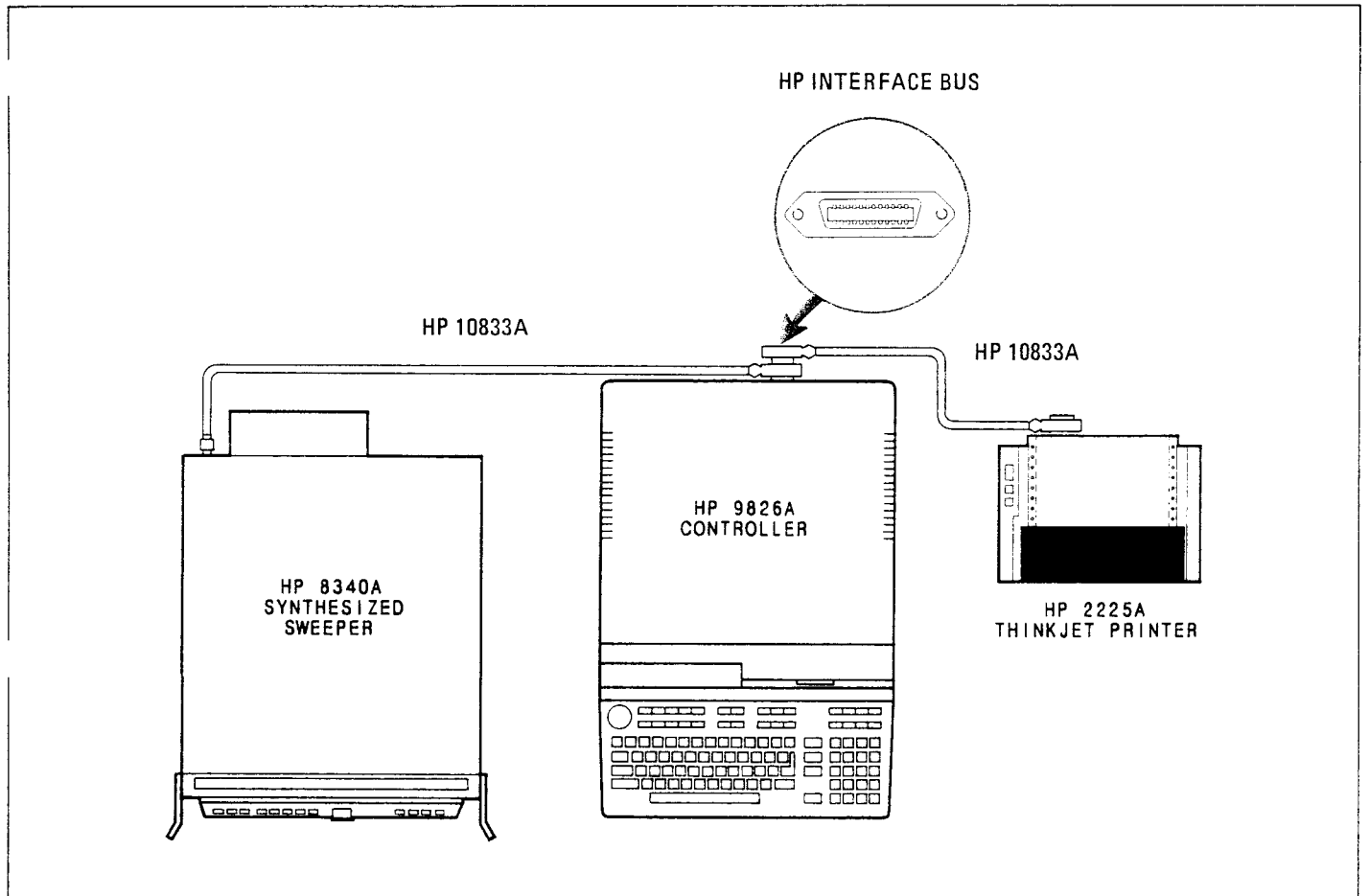

Figure 1. Connection System

Continue the above program and type in the following commands:

```

90 REMOTE S0
100 LOCAL LOCKOUT 7
110 LINPUT "LOCAL LOCKOUT MODE",A$
120 LOCAL 7
130 LINPUT "RETURN TO LOCAL",A$
140 OUTPUT S0;"IP"
150 END

```

To verify and investigate the different remote modes do the following:

1. Press **[SHIFT] [PAUSE]** to reset the HP 9826A.
2. Press **[INSTR PRESET]** on the HP 8340A.
3. Press **[SHIFT] [CLR LN]** to clear the screen, then press **[RUN]** on the HP 9826A.
4. With the HP 9826A displaying "ACTIVE CONTROLLER" and "REMOTE" messages, verify that the HP 8340A REMOTE light is lit. From the front panel, attempt to change the start frequency and verify that this is impossible. Verify that the INSTRUMENT PRESET key and all other keys except LOCAL are disabled. Now press the **[LOCAL]** key and verify that the HP 8340A REMOTE light is off and that you can modify any of the sweep functions.
5. Press **[CONTINUE]** on the HP 9826A. With the HP 9826A displaying "LOCAL LOCKOUT MODE", verify that the HP 8340A REMOTE light is again lit. Again attempt to change the start frequency and perform an Instrument Preset. Verify that this is impossible. Now press the HP 8340A **[LOCAL]** key and verify that still no action is taken.
6. Press **[CONTINUE]** on the HP 9826A. With the HP 9826A displaying "RETURN TO LOCAL", verify that the HP 8340A REMOTE light is off. Also verify that all sweep functions now can be modified via the front panel controls.
7. Press **[CONTINUE]** on the HP 9826A. Verify that the HP 8340A has undergone an Instrument Preset. The Output (**OUTPUT 719**) statement performs a **REMOTE 719** which passes instructions to the HP 8340A.

Note that the HP 8340A LOCAL key produces the same result as programming **LOCAL 719** or **LOCAL 7**. Be careful as the latter command places all instruments on the HP-IB in the local state as opposed to just the HP 8340A alone.

## Programming Examples

The following sample programs show the various ways of controlling the HP 8340A. In remote control situations the HP 8340A synthesized sweeper interacts with the system HP-IB controller in two basic ways:

1. "Listen Mode" : The HP 8340A listens to the control commands instructing it to modify the present instrument state. This commands the HP 8340A to do a specific event just like setting a front panel function.
2. "Talk Mode" : The HP 8340A informs the controller of the present instrument state with a numeric value or a string of characters. This allows the user to interrogate or learn any HP 8340A function.

Each programming example is structured using the following format:

1. A general description of the functions exercised.
2. The program listing.
3. Instructions for operating the system and explanation of the program.

## Example Program 1: Setting Up A Typical Sweep

In swept operation, the synthesized sweeper is programmed for the proper sweep frequency range, sweep time, power level, and marker frequencies for a test measurement. This program sets up the HP 8340A for a general purpose situation using several dedicated format and image statements.

To program any function on the HP 8340A, the controller must pass specific program codes and data to the instrument. The statement that allows this is the **OUTPUT** statement. The alphanumeric data string of the output statement can be a concatenation of character strings and/or variables. The data can be specific codes, free field formatted data, or can reference a specific **IMAGE** statement. For example, to program the Start Frequency (**FA**), one program code sequence is **FA**, followed by the frequency in GHz, then **GZ**. If the frequency is to be 1.234 GHz, then the string "**FA1.234GZ**" will suffice. However, if the frequency were to change then a variable **F** could indicate the frequency in GHz and the program string could be "**FA**"; **F**; "**GZ**". Finally, using an image statement will allow a specific number of digits to be passed, thereby avoiding any unexpected round off errors.

### Program 1

```

10 !SETTING UP A SWEEP
20 S0=719
30 PRINT CHR$(12)
40 OUTPUT S0;"IPFA1.234GZFB5.678GZ"
50 PRINT "START FREQUENCY is 1.234 GHz"
60 PRINT "STOP FREQUENCY is 5.678 GHz"
70 DISP "ENTER SWEEP TIME in msec";
80 INPUT T
90 PRINT "SWEEP TIME is ",T,"msec"
100 OUTPUT S0;"ST";T;"MS"
110 IMAGE "PL",SDD,"DB"
120 DISP "ENTER POWER LEVEL in dBm";
130 INPUT P
140 PRINT "POWER LEVEL is ",P,"dBm"
150 OUTPUT S0 USING 110;P
160 DIM A$(1)
170 LINPUT "PRESS CONTINUE",A$
180 IMAGE "M1",K,"GZ"
190 OUTPUT S0 USING 180;3.5
200 OUTPUT S0;"M24666E6"
210 PRINT "MARKER No 1 is 3.5 GHz"
220 PRINT "MARKER No 2 is 4.666 GHz"
230 LINPUT "SETTING COMPLETED",A$
240 END

```

### Program 1 Explanation and Operation

The equipment set-up is the same as in the check-out description. Reset the HP 9826A, scratch its memory and enter the above program. Then perform the following:

1. Run the program and observe that the HP 9826A CRT display is cleared (line 30) by printing a Form Feed. Then the HP 8340A is set to START/STOP Frequency mode. This first programming sequence is the most common format used to program the HP 8340A: "**FA1.234GZFB5.678GZ**" is sent on the same line after the **OUTPUT S0** command. Then the values of Start and Stop frequencies are printed on the CRT display (lines 40 to 60).



2. When a parameter is subject to change, the value is entered from the controller keyboard into a variable. In this example, the sweep time is entered in milliseconds into the variable T. Then, the Sweep Time is programmed using the following format: "ST";T;"MS" and the value of Sweep Time is printed on CRT display (lines 70 to 100).

3. When a parameter is to be entered in a specific format, an image statement is used to select the number of digits and sign to be passed. The free format to program POWER LEVEL on the HP 8340A allows two digits after the decimal point. In this example, the IMAGE statement changes this format, suppressing the two digits after the decimal point. The S causes the output of a leading plus or minus and indicates the sign of a number. The two D's cause the two digits of the number to be output. The value entered by the user is displayed on the CRT, then rounded by the HP 9826A to the nearest "dB" resolution, and then sent to the HP 8340A. The value printed can be compared to the value in the HP 8340A ENTRY DISPLAY (lines 110 to 150).

To enter another value of Power Level, press [PAUSE] and type in CONT 110 then [EXECUTE] and enter the new value of POWER LEVEL.

4. Press [CONTINUE] and Marker 1 is set to a fixed value using an IMAGE Statement (lines 160 to 180). Then Marker 2 is set to 4666 MHz using a full data format: the value of the frequency is sent in Hz and it is not necessary to terminate the programming sequence with a units terminator. Hertz is a default terminator. Then the Marker 1 and 2 values are displayed on the CRT (lines 200 to 220).

When a typical sweep like the above example is set up, the complete front panel state may be saved for later use in non-volatile memories called Registers 1 through 9.

This can be done remotely as a part of the above program by pressing [EDIT] [EXECUTE] on the HP 9826A, and adding the following lines:

```
240 OUTPUT S0;"SV11P"
250 PRINT "SETTING STORED IN REGISTER 1"
260 WAIT 3
270 OUTPUT S0;"RC1"
280 END
```

Then press [RUN], and enter new values for the typical sweep. When "SETTING COMPLETED" is displayed, press [CONTINUE]. The HP 9826A will save in Register 1 the previous sweep and then put the HP 8340A in the Instrument Preset state. After a 3 second delay, Register 1 is recalled and the saved state is reactivated.

## Example Program 2:

### A Stepped CW Sweep

Many automatic measurement systems make measurements at a sequence of CW test frequencies instead of digitizing an analog sweep in the frequency range of interest. If swept, the measurement data-taking machine would need to sample the RF signal at a very fast rate to maintain accurate frequency information. Stepped CW Sweeps also offer the advantage of maintaining the synthesized frequency features of the HP 8340A at each frequency. A stepped CW Sweep can be accomplished in several ways.

1. Program sequential CW test frequencies.
2. Program the frequency sweep range then enable the manual sweep mode. Perform a stepped manual sweep by repetitively programming the step up/increment function.
3. Program the CW frequency to the start frequency, the Step Size to an appropriate value, then repetitively program the step up/increment function.

Considering the speed of programming the above approaches, methods 2 and 3 are most efficient time wise. This program illustrates a stepped sweep using the third approach.

## Program 2

```
10 ! STEPPED CW
20 S0=719
30 PRINT CHR$(12)
40 OUTPUT S0;"IPSHPM1ST200MS"
50 DISP "ENTER START FREQUENCY in GHz";
60 INPUT A
70 DISP "ENTER STOP FREQUENCY in GHz";
80 INPUT B
90 IF A>B THEN GOTO 50
100 DISP "ENTER STEP SIZE in GHz";
110 INPUT S
120 IF S>B-A THEN 90
130 D=(B-A)/S
140 INTEGER D
150 PRINT "THE 8340A IS STEPPED SWEEPING"
160 PRINT "... TO STOP THE SWEEP: PRESS PAUSE"
170 OUTPUT S0;"SF";S;"GZCW";A;"GZS1"
180 FOR I=1 TO D
190 OUTPUT S0;"UP"
200 WAIT 1
210 NEXT I
220 GOTO 170
230 END
```

## Program 2 Explanation:

### Lines

- 10-40:** The HP 8340A address is entered in S0 and the HP 9826A CRT display is cleared. Then the HP 8340A is put in a predefined state via Instrument Preset, the square wave input is enabled and the sweep time is set to 200 msec.
- 50-90:** Start frequency is entered in variable A and stop frequency in variable B. If A>B other values must be entered.
- 100-120:** Frequency step size is entered in variable S and compared to the full sweep. If S>B-A, another step value must be entered.
- 130-140:** The number of steps is calculated and assigned to D and made to be an integer.
- 150-170:** A message is displayed on the CRT. Frequency step size is set to the desired increment and the CW frequency is set to the start value. In the continuous sweep mode (S1) the HP 8340A delivers a 0-10 V ramp for each CW frequency value at its sweep output connector. The HP 8757A scalar analyzer needs this 0-10 V ramp to drive and update its display.
- 180-220:** The HP 8340A frequency is incremented by the determined step size every 1 second from start to stop frequency. When the stop frequency is reached, the HP 8340A is programmed back to the start frequency and the cycle begins again.

Set up the equipment as shown in Figure 2 by adding the HP 8757A the HP 11664E, and a test device like a 4 to 6 GHz Bandpass Filter. It is important that the three rear panel and modulation drive connections are made from the HP 8340A to the HP 8757A for a proper CRT display. For the example measurement, set the following front panel controls:

On the HP 8757A:

Press: **[PRESET]**  
**[CHAN1 OFF]** (soft key)  
**[SCALE] 10 [dBm/dB]**  
**[REF] -10 [dBm/dB]**  
**[ENT OFF]**

Reset the HP 9826A, scratch the memory and type in the above program. Then perform the following:

1. Run the program and enter the start frequency. Then press **[CONTINUE]**, enter the stop frequency, then press **[CONTINUE]** again.
2. Enter the frequency step size and press **[CONTINUE]**.

The HP 8340A is now being stepped in frequency between the start and stop frequencies.

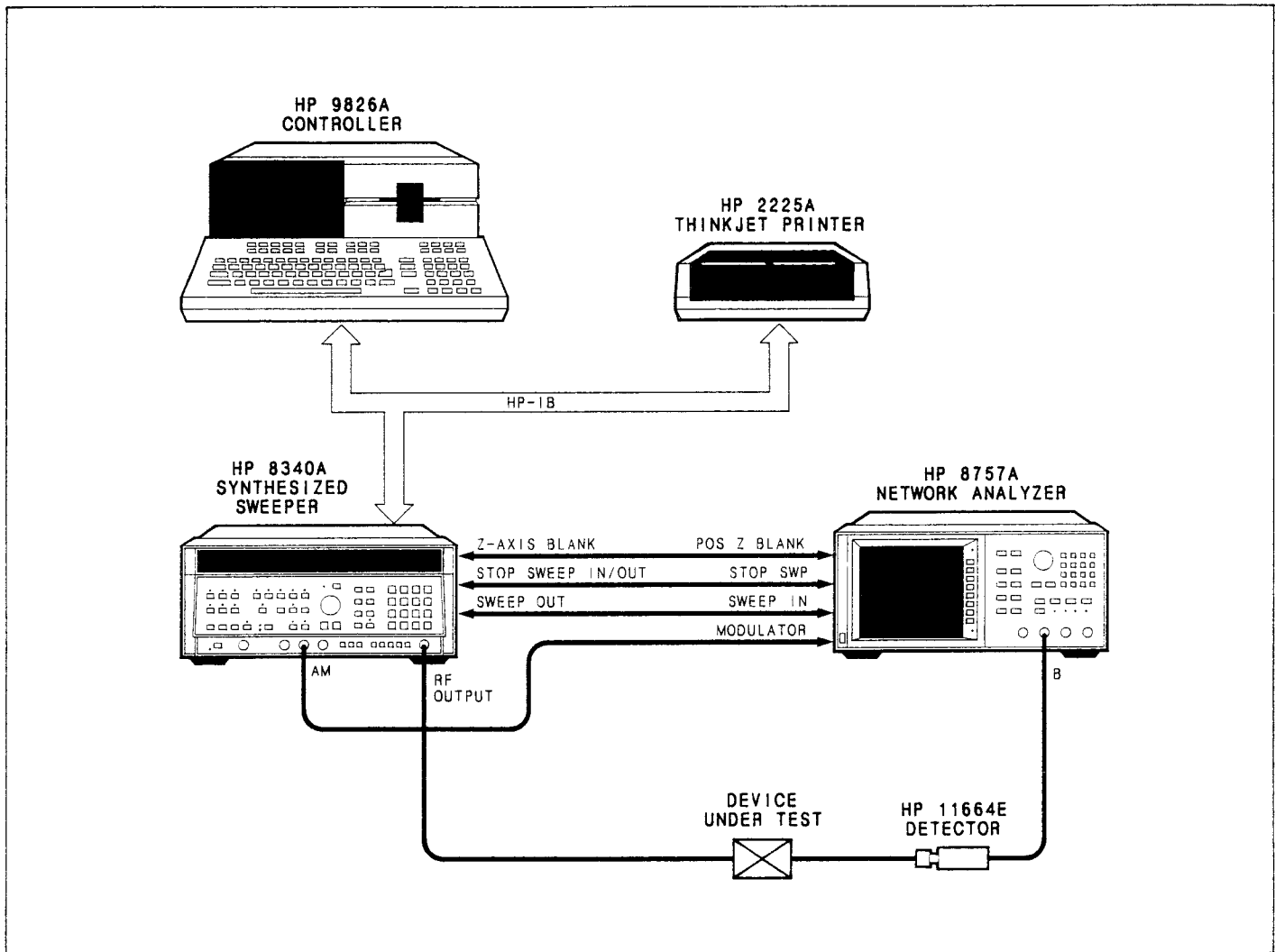

Figure 2. Equipment Setup

### Example Program 3: Setting Up A Power Sweep

The HP 8340A can sweep output power level as well as frequency. The start level of a power sweep is entered using the power level control. The power sweep width (dB/SWP) is entered using the power sweep function. In the coupled mode of operation, the ALC loop and 10 dB step attenuator are automatically coupled. The ALC loop dynamic range covers from  $-20$  dBm to  $+20$  dBm and is centered around  $0$  dBm. Note that the power sweep cannot cross an internal attenuator switch point. The maximum power sweep range is thus determined by the difference of the lowest ALC power before the attenuator switch point ( $-9.95$  dBm) and the maximum power available from the ALC loop (Figure 3b).

However, since the ALC can operate as low as  $-20$  dBm, the power sweep range can be extended by decoupling the ALC loop and output attenuator. Then the maximum power sweep range is from the bottom of ALC loop dynamic range ( $-20$  dBm) to the maximum power available in the ALC loop (Figure 3c). The 90dB step attenuator is available as Option 001 on the P 8341A.

The following program illustrates the two different modes of using power sweep.

### Program 3

```

10 !SETTING POWER SWEEP
20 S0=719
30 PRINT CHR$(12)
40 OUTPUT S0;"IPSHPM1ST200MS"
50 OUTPUT S0;"CW5GZPL-19.95DBPS115DBEK"
60 DIM A$(1)
70 LINPUT "PRESS CONTINUE",A$
80 OUTPUT S0;"CW18GZPS110DBEK"
90 LINPUT "PRESS CONTINUE TO EXTEND POWER SWEEP OVER
20 DB",A$
100 OUTPUT S0;"CW5GZPL-20DBSHPS-20DBPS128DBEK"
110 LINPUT "...PRESS CONTINUE",A$
120 OUTPUT S0;"CW18GZPS121DBEK"
130 PRINT ".....END"
140 END

```

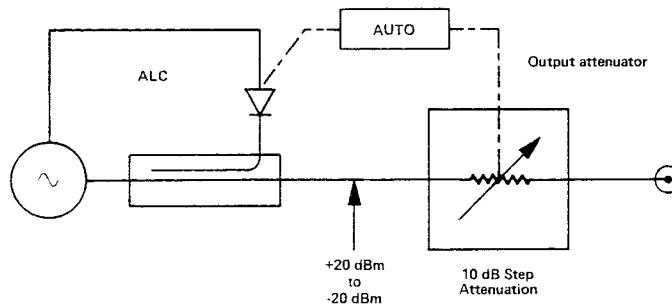

(a)

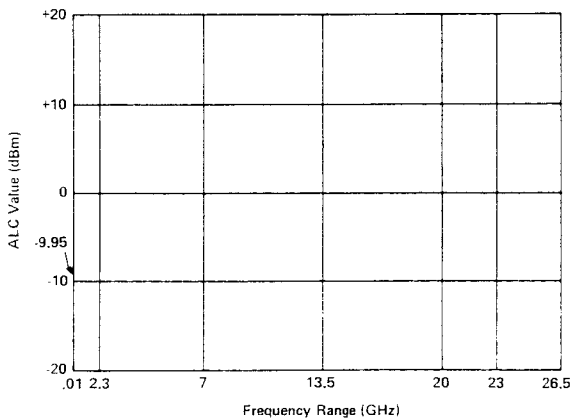

(b)

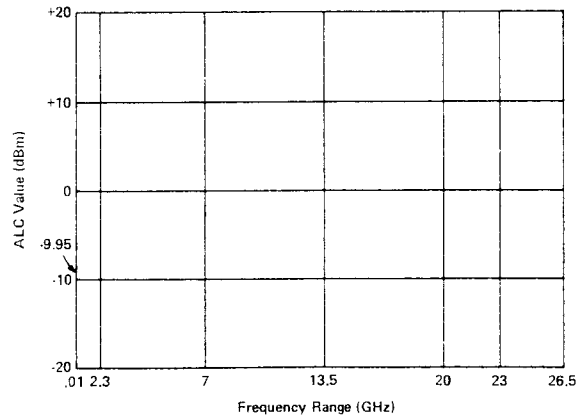

(c)

Figure 3. Power Sweep Range

### Program 3 Explanation:

#### Lines:

- 10-40:** The HP 9826A CRT is cleared, the HP 8340A undergoes an Instrument Preset, the square wave input is enabled and the sweep time is set to 200 msec.
- 50-70:** Program the CW frequency to 5 GHz, the power level to  $-19.95$  dBm and set the power sweep to 15 dB. Then the knob is enabled for data entries on the last programmed function; in this case, power sweep. Then, the program execution is temporarily stopped.
- 80-90:** With respect to the previous setting, only the frequency is changed and set to 18 GHz, but the power sweep must be programmed again to ensure that the knob will control power sweep data entries.
- 100-110:** Sets CW frequency to 5 GHz, power level to  $-20$  dBm, decouples ALC loop and output attenuator and sets ALC power level to  $-20$  dBm. Then the power sweep is set to 28 dB and the knob is enabled for power sweep entries.
- 120-140:** With respect to the previous setting, the frequency is changed to 18 GHz, and power sweep is set to 21 dB. Then the knob is enabled for power sweep data entries.

The equipment setup is the same as the previous example. Reset the HP 9826A, scratch the memory, type in the above program and then run the program and perform the following:

1. The CW frequency is set to 5 GHz, the power level to  $-19.95$  dBm and the power sweep to 15 dB. Since the HP 8340A is operating in the coupled mode, the output attenuator is set to 10 dB attenuation and the power level is set to  $-9.95$  dBm to  $+5.05$  dBm in the ALC loop.

Note that the HP 8340A is still in remote, but the program has enabled the knob on the HP 8340A front panel so that the power sweep value may be adjusted. Extend the power sweep range with the knob until the power output UNLEVELED light is lit. The ENTRY DISPLAY now reads the typical power sweep range at 5 GHz.

2. The frequency is set to 18 GHz. At this frequency, the maximum specified power level is  $+9$  dBm. The ALC loop is set to  $-9.95$  dBm, so the maximum specified power sweep range is 18.95 dB. Extend the power sweep with the knob to reach the typical value.

If the synthesized sweeper does not have a step attenuator installed, the ALC can operate as low as  $-20$  dBm (figure 3c) and the results in steps 1 and 2 will be the same as in steps 3 and 4.

3. The frequency is then set back to 5 GHz and the power level to  $-20$  dBm, automatically putting in 20 dB attenuation. Then the ALC loop and output attenuator are decoupled by executing [SHIFT] [PWR SWP]. The ALC loop value can now be adjusted between  $-20$  dBm and  $+20$  dBm without causing a change in the attenuator setting. The ALC loop power level is programmed to  $-20$  dBm. Next, the power sweep range is set to the specified value at 5 GHz: 28 dB. Adjust power sweep with the knob to get a typical value. If the unlevelled light does not come on, the HP 8340A is putting out at least 20 dBm of output power even though it is only specified for 12 dBm at 5 GHz.
4. The fourth step of the program changes frequency to 18 GHz and power sweep to the specified power sweep range: 21 dB. Check, using the knob, for the typical power sweep range.

### Example Program 4:

#### Modulating the HP 8340A

The HP 8340A features both Amplitude Modulation and Pulse Modulation via a modulating signal from an external signal source. Detailed Specifications can be found in the HP 8340A Operating and Service Manual. Pulse modulation is available as Option 006 on the HP 8341A.

The following program describes a typical modulation set-up and automatically displays the modulated signal on the HP 8566B spectrum analyzer.

### Program 4

```
10 !MODULATION
20 S0=719
30 S1=718
40 PRINT CHR$(12)
50 OUTPUT S0;"IP"
60 DISP "ENTER FREQUENCY in GHz";
70 INPUT F
80 OUTPUT S0;"CW";F;"GZ"
90 !AM
100 OUTPUT S0;"AM1"
110 A=20
120 GOSUB Spectrum
130 DIM A$(1)
140 INPUT "PRESS CONTINUE",A$
150 !PM
160 OUTPUT S0;"AM0PM1"
170 A=1500
180 GOSUB Spectrum
190 GOTO 230
200 Spectrum: OUTPUT S1;"IPCF";F;"GZSP";A;"KZ"
210 LOCAL S1
220 RETURN
230 PRINT "...END"
240 END
```

### Program 4 Explanation:

#### Lines:

- 10-50:** Set HP 8340A HP-IB address to S0 and HP 8466B spectrum analyzer HP-IB address to S1. Then the HP 9826A CRT is cleared and HP 8340A put into its predetermined state via Instrument Preset.
- 60-80:** Allow the operator to enter CW frequency in the variable F. Then program the CW frequency.
- 90-140:** Program Amplitude Modulation on HP 8340A and put span width information in variable A. Then go to the "Spectrum" subroutine for an automatic Frequency Spectrum display of the amplitude modulated signal. Program execution is then temporarily stopped.
- 150-190:** After the user presses [CONTINUE], amplitude modulation is turned off and pulse modulation turned on. Span width information is then stored in the variable A and the program proceeds to the "Spectrum" subroutine.
- 200-220:** Programs the HP 8566B to center frequency and span width, then returns the HP 8566B to local.
- 230-240:** Print "END" message.

Setup the equipment as shown in figure 4 by connecting the HP 8340A output to the HP 8566B spectrum analyzer input using the appropriate adapters and cable. Connect the output of the HP 3312A to the amplitude modulation BNC input connector and connect the HP 8011A output to the pulse modulation BNC input connector. Connect the 10 MHz REF output of HP 8340A to the REF input on HP 8566B. Set the modulation sources as follows:

HP 3312A:  
 FUNCTION ..... Sine  
 RANGE ..... 1K  
 FREQUENCY ..... 5  
 OFFSET ..... CAL  
 AMPLITUDE ..... 1 Vp-p

HP 8011A:  
 PULSE PERIOD ..... 1 ms to 5 ms  
 PULSE WIDTH ..... 1  $\mu$ s to 50  $\mu$ s  
 AMPLITUDE ..... 5V  
 OUTPUT MODE ..... Internal load

Run the program. Then enter a CW frequency and press [CONTINUE]. The HP 8566B CRT displays the amplitude modulated signal. The modulating frequency can be changed on the HP 3312A. Change the frequency span with the knob on the HP 8566B spectrum analyzer if necessary.

Next, press [CONTINUE] and the HP 8566B CRT will display a pulse modulated signal.

The pulse width and pulse repetition frequency may be changed on the HP 8011A pulse generator. Again, change the frequency span on the HP 8566B with the knob if necessary.

### Example Program 5: Learning An Instrument State

Being able to save a specific instrument state is helpful when it is needed several times in a test or measurement procedure. The user could save the instrument state by manually logging the important sweep parameters (such as frequency range, power level, ALC modes, etc.) then re-inputting them at the appropriate time. A somewhat simpler approach is to save the instrument state in one of the HP 8340A internal storage registers, then recall it when needed. (See example program 1.) Another solution is to use the Output Learn String function of the HP 8340A so that the HP 9826A can learn and then store a data string that describes the present instrument state on a disk or in its internal memory. Once an instrument state is stored or learned, the HP 8340A can be restored to that state using the Input Learn String function. The power of these instrument Learn/Teach functions are demonstrated by the following program.

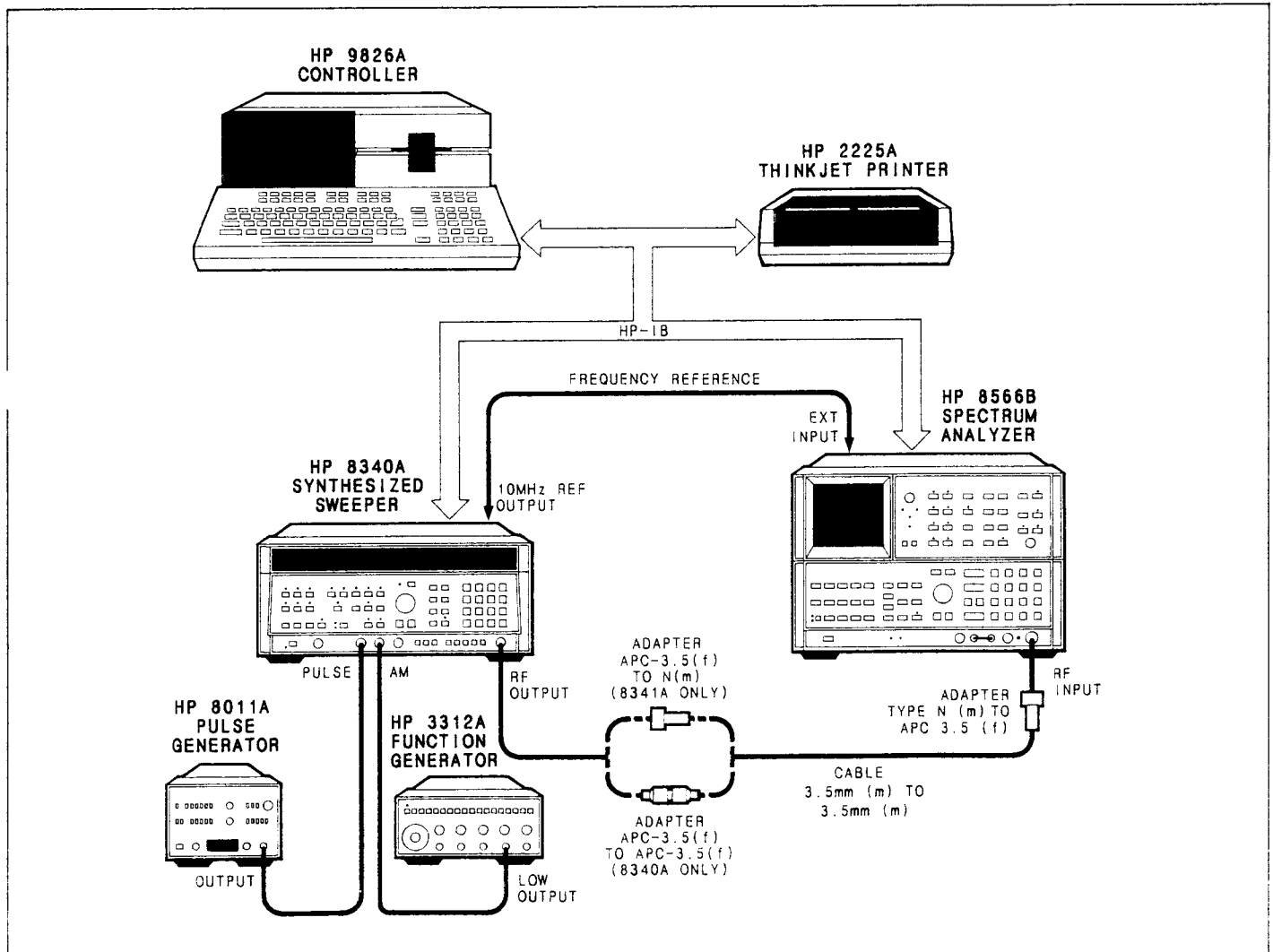

Figure 4. Modulation Setup

## Program 5

```
10 !LEARN STRING
20 S0=719
30 PRINT CHR$(12)
40 OPTION BASE 1
50 DIM B$(150)
60 OUTPUT S0; ``IPSHPM1ST200MS``
70 LOCAL S0
80 DIM A$(1)
90 LINPUT ``CHANGE FRONT PANEL CONFIGURATION``, A$
100 BEEP 1000,.1
110 OUTPUT S0; ``DL``
120 ENTER S0 USING ``#,123A``; B$
130 LOCAL S0
140 LINPUT ``CHANGE FRONT PANEL CONFIGURATION
    AGAIN``, A$
150 BEEP 2000,.1
160 OUTPUT S0; ``IL``&B$
170 PRINT ``...END``
180 END
```

## Program 5 Explanation:

### Lines:

- 10-30:** Assign S0 to the HP 8340A address and clear the HP 9826A CRT.
- 40:** Define the first element of any array to be at index number 1.
- 50:** Set the length of the B\$ string to 150 characters.
- 60-90:** Set the HP 8340A to a predefined state via Instrument Preset, enable square wave modulation input and set the sweep time to 200 msec. Then ask the user to change the instrument state and return the HP 8340A to local control so he may do so.
- 100-110:** Send an audible beep and program the HP 8340A to output the current instrument settings (the learn string) into the HP 9826A.
- 120:** Read the learn string into the HP 9826A using a byte fast handshake transfer of 123 characters ignoring the line feed on the string terminator. Store the 123 character learn string in B\$.
- 130-140:** Return the HP 8340A to local and ask the user to again change the HP 8340A front panel state, temporarily halting the program until he does so.
- 150-180:** After sending out the audible beep, input the learn string to the HP 8340A causing it to return to the state set by the user during lines 60-90 of the program. Then prompt the user that the program is finished.

Set the equipment as in example 2 using the analyzer's CRT display to verify the sweep settings.

Reset the HP 9826A, scratch the memory, then type in the above program. Clear the HP 9826A CRT display, then run the program. The HP 8340A will undergo an Instrument Preset, enable the square wave modulation input, set the sweep time to 200 msec, then return to local front panel control. Then perform the following:

1. Adjust the HP 8340A to a preferred instrument state, then press **[CONTINUE]** on the HP 9826A.
2. Press **[INSTR PRESET]**, or change the instrument settings in any way desired.
3. Press **[CONTINUE]** on the HP 9826A. Verify on the analyzer's CRT display and/or the HP 8340A front panel that the original instrument state has been restored.

## Example Program 6:

### *Interrogating The Present Value Of A Function*

While the HP 8340A Learn String enables the user to save a string of characters that completely defines the present instrument state, the information is densely packed and encoded to save memory space. If the user wishes to determine the actual value of a specific parameter, say the Start Frequency, it would require a tedious process to extract a numeric value from several characters within the Learn String. An easier approach is to use the Output Interrogated Parameter function of the HP 8340A. With this function the HP 9826A instructs the HP 8340A to output the present numeric value of a specified function. Any function that has a numeric value associated with it can be interrogated even if this function is not presently active. The following program demonstrates the capability of the interrogate function. It shows how to get the current value of a parameter whether it has been entered in the HP 8340A or computed by the HP 8340A internal processor.

## Program 6

```
10 !OUTPUTS FROM 8340A
20 S0=719
30 PRINT CHR$(12)
40 OUTPUT S0;"IPSHPM1ST200MS"
50 OUTPUT S0;"FAEK"
60 DIM A$(1)
70 LINPUT "ADJUST START FREQUENCY WITH KNOB", A$
80 OUTPUT S0;"0A"
90 ENTER S0;A
100 OUTPUT S0;"FBEK"
110 LINPUT "ADJUST STOP FREQUENCY WITH KNOB", A$
120 OUTPUT S0;"0A"
130 ENTER S0;B
140 C=(B-A)/2+A
150 OUTPUT S0;"OPCF"
160 ENTER S0;D
170 PRINT "CF computed by 9826A is";C/1.E+6;"MHZ"
180 PRINT "CF output from 8340A is";D/1.E+6;"MHZ"
190 OUTPUT S0;"CW18GZS1PL15DB"
200 LINPUT "PRESS CONTINUE TO OUTPUT THE POWER", A$
210 OUTPUT S0;"0R"
220 ENTER S0;P
230 PRINT "POWER LEVEL in ENTRY display is 15 dBm"
240 PRINT "Real Output POWER LEVEL is";P;"dBm"
250 END
```

## Program 6 Explanation:

### Lines:

- 10-40:** Assign S0 to the HP 8340A address and clear the HP 9826A CRT. Set the HP 8340A in the Instrument Preset state, enable the HP 8340A square wave modulation input and set the sweep time to 200 msec.
- 50-70:** Enable the knob to adjust Start Frequency and temporarily halt the program.
- 80-90:** Program the HP 8340A to output the numeric value associated with the last active function. (In this case, Start Frequency). This value is then entered in the variable A.
- 100-110:** Enable the knob to adjust Stop Frequency and temporarily halt the program.
- 120-130:** Same as lines 80-90 for Stop Frequency.
- 140:** The HP 9826A computes Center Frequency from the A and B variables and stores this in the variable C.
- 150-160:** Program the HP 8340A to output the current value of a specified parameter. In this case, the desired parameter is the CF computed by the internal processor of the HP 8340A from the Start and Stop frequencies previously entered. This value is then stored in the variable D.

- 170-180: Display both values of Center Frequency stored in C and D.
- 190-200: Program CW frequency to 18 GHz and power level to 15 dBm. Then, output a prompt to the user and temporarily halt program execution.
- 210-220: Program the HP 8340A to output the real output power. This is done with the OR command, which reads the value shown in the POWER dBm display of the HP 8340A. It is always the actual power of the signal coming out of the RF connector. The value obtained is assigned to P.
- 230-250: Print the value of power in the ENTRY DISPLAY on the HP 8340A and the value of power in the POWER dBm display on the HP 8340A.

The equipment required is the same as in the previous example. Reset the HP 9826A and scratch the memory. Now type in the above program and run it. Then perform the following:

1. Adjust the Start frequency value with the knob. Then press [CONTINUE].
2. Adjust the Stop frequency value with the knob. Then press [CONTINUE].

**Note**

The resolution of start and stop frequencies will probably be different. This is normal because the frequency resolution changes as the sweep width ( $\Delta f$ ) is changed.

3. Center frequency values are displayed on the HP 9826A CRT. Then press [CONTINUE].
4. The CW Frequency is set to 18 GHz and power level to 15 dBm. Since the specified power at this frequency is +9 dBm (figure 3), the power will be unlevelled. The OR statement causes the actual power to be measured by the internal ADC and shows the value in the POWER dBm display, while the ENTRY DISPLAY shows the user-selected power level. The two values are printed on the HP 9826A CRT.

Another method to quickly transfer parameters which define a typical sweep is to use the Output Coupled Parameter statement OC. This statement outputs three values representing:

1. Start Frequency in Hertz
2. Center Frequency in Hertz
3. Sweep Time in Seconds

Modify the above program by typing in the following lines:

**Program 6 (continued)**

```

250 LINPUT "PRESS CONTINUE",A$
260 !OUTPUT COUPLED PARAMETERS
270 OUTPUT S0;"FAPLODBOC"
280 ENTER S0;F,G,H
290 PRINT
300 PRINT "START FREQUENCY IS",F/1.E+6,"MHz"
310 PRINT "CENTER FREQUENCY IS",G/1.E+6,"MHz"
320 PRINT "SWEEP TIME IS",H*1000,"msec"
330 END

```

**Explanation:**

On line 270, the HP 8340A is programmed to Output Coupled Parameters.

On line 280, the three parameter values are put in variables F for Start Frequency, G for Center Frequency, and H for Sweep Time.

On lines 300 to 320 parameter values are displayed on the HP 9826A CRT. Frequencies are displayed in megahertz and sweep time in milliseconds.

Run the modified program and the coupled parameters will be displayed on the HP 9826A CRT.

**Example Program 7:  
Using Service Requests, Status Bytes,  
and Request Mask**

Certain error conditions of the HP 8340A can be detected by the HP 9826A so that corrective action can be taken. A few examples of detectable error conditions are RF power unlevelled, RF unlocked, programming syntax error and power failure. If an error condition exists, the user can instruct the HP 8340A to request service from the HP 9826A by initiating a Service Request (SRQ). The HP 9826A can detect whether an SRQ has taken place on the bus by analyzing bit 1 of its interrupt status register (Register 4 on the HP 9826A HP-IB interface - see Table 1). Two methods are available for analyzing the status of the HP-IB interface of the HP 9826A: (1) periodically read the interrupt status register (Register 4). (2) enable the bit 1 of the Interrupt Enable Mask (Register 5) to interrupt the program when bit 1 is set. In either case, the user must determine which device on the bus requested service. This can be done using an SPOLL command to sequentially analyze the status byte of each instrument on the bus. By definition of the IEEE-488 bus, the instrument that requested service will have bit 6 of its status byte (REQUEST SERVICE) true. Once it is determined that the HP 8340A has requested service, the specific error condition(s) is then determined by analyzing the Status Bytes of the HP 8340A. The HP 8340A has two Status Bytes, each consisting of 8 bits with each bit indicating the present status of a particular function or condition. See Table 2 for a complete description of the conditions associated with each status byte bit. The user can analyze all of the conditions of the status bytes for every SRQ, or more simply, instruct the HP 8340A to issue an SRQ only if a specific set of error conditions exists. The set of error conditions is determined by a numeric value generated by summing the decimal values of each bit to be checked in the first Status Byte. Its binary equivalent is sent to the HP 8340A using the Request Mask function (RM) and CHR\$.

The following program demonstrates the capability of the SRQ and the two Status Bytes to detect an error condition. This specific example analyzes an SRQ on an unlevelled power condition, an RF unlocked condition and a front panel service request when the instrument is in local mode.

**Program 7**

```

10 !STATUS BYTES
20 S0=719
30 ABORT 7
40 CLEAR S0
50 PRINT CHR$(12)
60 ENABLE INTR 7;2
70 OUTPUT S0;"RM"&CHR$(5)
80 ON INTR 7 GOSUB Statusbyte1
90 OUTPUT S0;"IPCSSHPM1ST200MSCW15GZT1PL"
100 LOCAL S0
110 DISP "CHANGE POWER LEVEL WITH KNOB/STEP KEYS/DATA
    ENTRY KEYBOARD
120 GOTO 120
130 Statusbyte1:  STATUS 7,4:A
140 B=SPOLL(S0)
150 IF BIT(B,0)=1 THEN PRINT "FRONT PANEL SRQ"
160 IF BIT(B,2)=1 THEN GOSUB Statusbyte2
170 ENABLE INTR 7;2
180 RETURN
190 Statusbyte2:  OUTPUT S0;"CSOS"! (SEE NOTE 3)
200 ENTER S0 USING "#,B";E,F
210 IF BIT(F,4)=1 THEN PRINT "RF IS UNLOCKED"
220 IF BIT(F,4)=0 THEN PRINT "RF IS LOCKED"
230 IF BIT(F,6)=1 THEN PRINT "OUTPUT IS UNLEVELLED"
240 IF BIT(F,6)=0 THEN PRINT "OUTPUT IS LEVELED"
250 PRINT
260 LOCAL S0
270 RETURN
280 END

```

Table 1. HP-IB Status Registers 4 and 5 of the 9826A Controller

Status Register 4: Interrupt Status Status Register 5: Interrupt Enable Mask								
BIT #	15 (MSB) <sup>1</sup>	14	13	12	11	10	9	8
DECIMAL VALUE	32 768	16 364	8 192	4 096	2 048	1 024	512	256
FUNCTION	Active Controller	Parallel Poll Configuration Change	My Talk Address Received	My Listen Address Received	EOI Received	SPAS	Remote/Local Change	Talker/Listener Address Change
BIT #	7	6	5	4	3	2	1	0 (LSB) <sup>2</sup>
DECIMAL VALUE	128	64	32	16	8	4	2	1
FUNCTION	Trigger Received	Handshake Error	Unrecognized Universal Command	Secondary Command While Addressed	Clear Received	Unrecognized Addressed Command	SRQ Received	IFC Received
1. MSB: Most Significant Bit 2. LSB: Least Significant Bit								

Table 2. 8340A/8341A Status Byte Descriptions

STATUS BYTE (#1)								
BIT #	7	6	5	4	3	2	1	0
DECIMAL VALUE	128	64	32	16	8	4	2	1
FUNCTION	SRQ on New frequencies or Sweep Time in Effect	REQUEST SERVICE (RQS)	SRQ on HP-IB Syntax Error	SRQ on End of Sweep	SRQ on RF Settled	SRQ on Changed in Extended Status Byte	SRQ on Numeric Entry Completed (HP-IB or Front Panel)	SRQ on Any Front Panel Key Pressed
EXTENDED STATUS BYTE (#2)								
BIT #	7	6	5	4	3	2	1	0
DECIMAL VALUE	128	64 (L)	32 (L)	16 (L)	8	4	2	1 (L)
FUNCTION	Fault Indicator On	RF Unleveled	Power Failure	RF Unlocked	External Freq. Ref. Selected	Oven Cold	Over Modulation	Self Test Failed
(L): See Note 3.								



## Program 7 Explanation

### Lines

- 10-20: Assign the HP 8340A address in the variable SO.
- 30: Terminates all Listener or Talker functions of all instruments on the bus.
- 40: Clears the status bytes of the HP 8340A.
- 50: Clears the HP 9826A CRT display.
- 60: Enables an interruption on bit 1 (decimal value 2) on the HP 9826A status register 5.
- 70: Sets a Request Mask on HP 8340A on bit 0 (decimal value 1) and 2 (decimal value 4) of the first status byte. The binary equivalent of 5 (decimal values 4 + 1) is sent using CHR\$.
- 80: When the HP 9826A receives an interrupt, the program execution is continued on subroutine "Statusbyte1".
- 90: Presets the HP 8340A in a predetermined state via Instrument Preset. The status bytes are cleared via the CS command. Then the HP 8340A is programmed for a sweep time of 200 msec and a CW frequency of 15 GHz and the PL function is activated to allow the knob, step keys or data entry keyboard to control the output power level.
- 100-110: The HP 8340A is returned to local and a prompt is displayed on the HP 9826A CRT.
- 120: The program execution remains on the same line 120, waiting for an interruption.  
Note that this line can be the beginning of a user program.
- 130: Reads the current state of the interrupt status register (register 4) on the HP 9826A and stores its value in the variable A. Normally the variable A would then be examined to see what caused the interrupt, but since line 60 made bit 1 the only bit that could cause an interrupt, this is unnecessary.
- 140: Reads the current state of the first status byte of the HP 8340A and, in so doing, clears it. Note that it is unnecessary to examine bit 6 of B to see if the HP 8340A is the instrument that requested service because the HP 8340A is the only instrument on the bus in this example.
- 150: Tests bit 0 of first status byte. Then prints a prompt.
- 160: Tests bit 2 of first status byte and then sends program execution to continue on to subroutine "Statusbyte2" if necessary.
- 170: Re-enables an interruption on bit 1 on the HP 9826A status register 5.
- 180: Returns to main program execution.
- 190: Programs the HP 8340A to output both status bytes. (See Note 3).
- 200: Fast transfer of the two status bytes, in binary form, into variables E and F.
- 210-240: Test bits 4 and 6 of the extended status byte and print prompts depending on the current state of the tested bit.
- 250-280: Prints a space on the HP 9826A CRT, then sends the program execution back to line 170 of the subroutine "Statusbyte1".

Set-up the equipment as shown in figure 2 and use the analyzer's CRT display to verify the settings. Reset the HP 9826A and scratch its memory. Then type in and run the above program. Then perform the following:

1. The HP 8340A is set in CW mode at 15 GHz. The FREE RUN trigger is selected, giving a swept CW display on the analyzer's CRT.
2. The HP 8340A is in local mode but the program is still running. Thus, if any front panel key is pressed, an interruption occurs and the prompt "FRONT PANEL SRQ" is displayed on the computer and the program execution goes back on line, waiting for another interrupt. Note the HP 8340A is still in LOCAL.
3. An "RF UNLOCKED" interrupt may be generated by disconnecting the jumper that supplies the FREQUENCY STANDARD Reference. This jumper is connected between INT and EXT BNC connectors of the frequency standard input/output on the rear panel of the HP 8340A.
4. An SRQ is also obtained by adjusting the power level with the knob until the power becomes unlevelled. Then an SRQ occurs and an "OUTPUT IS UNLEVELED" prompt is displayed on HP 9826A CRT.

As bit 2 of the HP 8340A Status Byte shows, an SRQ occurs when a change in the extended status byte occurs. Thus, an SRQ is detected for a change either from the leveled or from the unlevelled state.

Note that whatever the origin of the SRQ, the current status of both bits 4 and 6 of the extended status byte is displayed.

### NOTE 3

**When an interruption occurs, this information is sent to the controller. With a priority pre-determined in the software, the controller will read the Status of the HP 8340A. Thus, the controller does not respond instantaneously to the Service Request. During this delay, the cause of the SRQ may have disappeared. To avoid having the controller get an SRQ with "no information", on some functions of the extended status byte the bit corresponding to the function requiring the service is latched even if the cause of the SRQ disappears before the controller has read the extended status byte. These functions are: overmodulation (bit 1), RF unlocked (bit 4), power failure (bit 5) and RF unlevelled (bit 6). Figure 5 shows how this latching works via two examples of output level power variations. In example (b) an SRQ is sent (t1) when the RF output is back to "leveled". But the RF output is back to "leveled" before the controller has read the status of line 3 (bit 6 of the extended status byte). Then the controller reads the latched information and in so doing, clears it (t2) so the user knows that an unlevelled output occurred between t1 and t2. To read from the status byte the current value of bit 6, it must be read twice (t3). In this case, the user then learns that the output is back to being leveled. In example (c), the controller detects an unlevelled state from the latched bit, and in the process of reading the bit, clears it. But the latched bit returns to "unlevelled" because the current state of the RF output is still unlevelled. So, if the extended status byte is read a second time, the current state (unlevelled) is measured.**

On line 190, a Clear Status bytes statement (CS) is used to clear both status bytes. Then, they are read again to learn the current state of the HP 8340A.

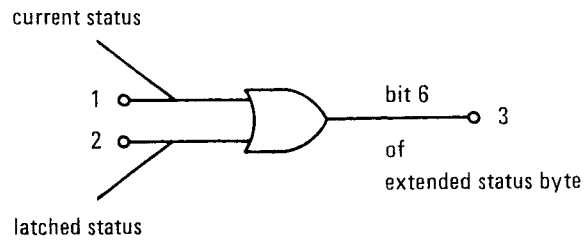

(a)

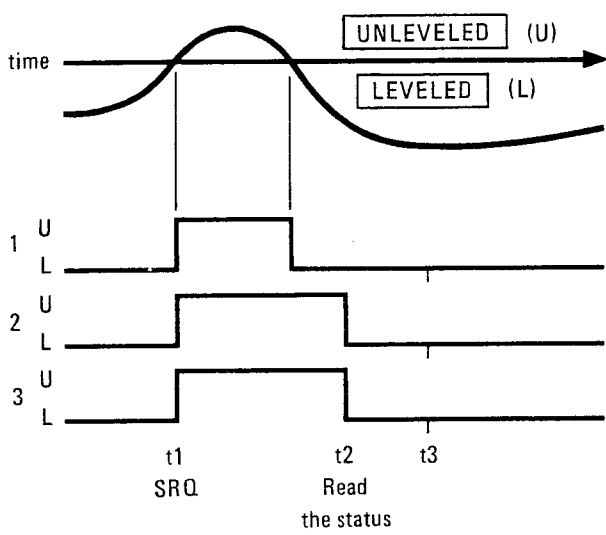

(b)

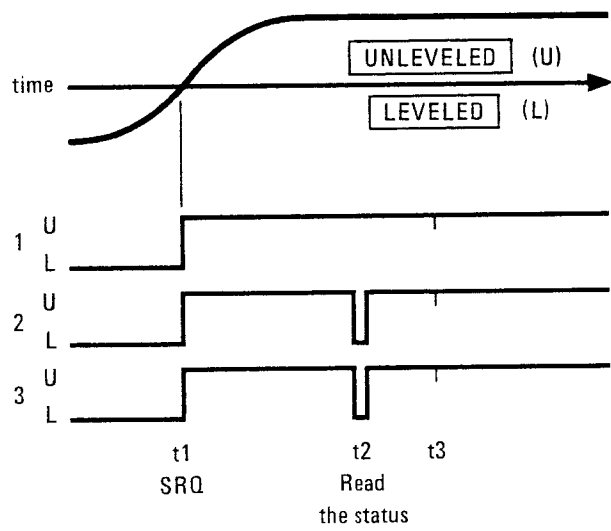

(c)

Figure 5. Example of Status Bit Latching

HP-IB Program Codes (1 of 2)

Code <sup>1,2</sup>	Description <sup>3</sup>	Code <sup>1,2</sup>	Description <sup>3</sup>
A1	Internal leveling	KZ	KHz
A2	External leveling with crystal detector	MO	Marker OFF
A3	External leveling with power meter	M1	Activates marker 1
AKm	Turns RF amplitude markers ON/OFF	M2	Activates marker 2
ALm	Turns alternate sweep mode ON/OFF	M3	Activates marker 3
AMn	Enables/disables amplitude modulation	M4	Activates marker 4
ASm	*Alternate state select 0 = current from panel state 1 = recalled state	M5	Activates marker 5
AT	*Attenuator Setting	MC	Activate marker to center frequency
AU	Puts fixed function into Auto (coupled) mode	MDm	Turns marker difference ON/OFF
BC	*Change frequency band	MPm	Turns marker sweep ON/OFF
CF	Center Frequency	MS	Milliseconds
CS	Clear both status bytes	MZ	MHz
CW	CW frequency	NAm	*Turns network analyzer mode ON/OFF
DB	dB or dBm	OA	*Output active parameter value
DF	Frequency span of sweep	OB	*Output next bandcross frequency
DN	Step down	OC	*Output coupled parameters
DUm	*Disable/Re-enable Display Updating	OD	*Output diagnostic numbers
EF	Entry off	OF	*Output Fault
EK	*Enable control knob	OK	*Output last lock frequency
FA	Start frequency	OL	*Output learn string
FB	Stop Frequency	OM	*Output mode string
GZ	GHz	OP	*Output interrogated parameter value
HZ	Hz	OR	*Output power level
IF	*Increment frequency	OS	*Output both status bytes
IL	*Input learn string	PL	Power level
IP	Instrument preset	PMm	Enables/disables pulse modulation
		PSm	Turns power sweep ON/OFF
		RB	*Control knob remotely
		RCn	Recalls instrument state
		RFm	Turns RF ON/OFF
		RM	*Send service request mask
		RPm	Turns RF peaking ON/OFF
		RS	*Reset sweep

NOTES

1. Program codes of the form "XXm" use "m" to turn the function On or Off (1 or 0).
2. The 8340A ignores spaces, plus signs, negative signs (except for the power values), and any unexpected characters. Program codes can be upper or lower case alpha characters.
3. Descriptions with an asterisk (\*) beside them denote an HP-IB only command.

HP-IB Program Codes (2 of 2)

Code <sup>1,2</sup>	Description <sup>3</sup>	Code <sup>1,2</sup>	Description <sup>3</sup>
S1	Continuous sweep	SH M1	Displays M, N, M/N loop frequency, 20/30 loop frequency
S2	Single sweep	SH M2	Displays band number, YIG oscillator frequency
S3	Manual frequency sweep	SH M3	Displays VC01, VC02 frequencies
SC	Seconds	SH M4	Diagnostic functions test/report
SF	*Set frequency step size	SH M5	Turn off diagnostic displays; restore display
SH	Shift key	SH MO	Turn all markers OFF
SLm	Turn slope ON/OFF	SH MP	Start frequency to M1; stop frequency to M2; original start/stop values discarded
SM	*Manual frequency sweep	SH PL	Power step size
SP	*Set power step size	SH PMm	Enable/disable square wave input for scalar analyzer
ST	Sweep time	SH PS	Decouple ALC and attenuator for independent control
SVn	Save instrument state	SH RC	Remove lock from Save/Recall registers
T1	Free run	SH RP	Automatic tracking calibration for swept mode
T2	Sweep triggered by power line frequency	SH S1m	Disable/re-enable display updating
T3	Sweep triggered externally	SH S3	Use when FAULT indicator comes on; blinking mnemonic shows cause of fault. See 8340A Operating and Service Manual
TI	*Test HP-IB interface	SH SL	Attenuator setting
TS	Take sweep	SH ST	Zoom mode
UP	Step up	SH SV	Lock save registers
	<b>SHIFT KEY FUNCTIONS</b>	SH T1	Active display self test
SH A1	Cause manual band cross	SH T2m	Enable/disable penlift for XY recorders at band crossing(s)
SH A2m	Disable/re-enable bandcrossing capability	SH T3	Use when UNLK annunciator comes on. Blinking mnemonic shows which oscillator is causing the unlocked condition. See 8340A Operating and Service Manual.
SH A3	Disable ALC to control modulator drive directly		
SH AM	Enable 100 kHz AM bandwidth while pulse modulating		
SH CF	Frequency step size		
SH CW	Set frequency resolution		

NOTES

1. Program codes of the form "XXm" use "m" to turn the function On or Off (1 or 0). For the storage register functions, the "n" is 1 through 9.
2. The 8340A ignores spaces, plus signs, negative signs (except for the power values), and any unexpected characters. Program codes can be upper or lower case alpha characters.
3. Descriptions with an asterisk (\*) beside them denote an HP-IB only command.

## Appendix A

### Introduction

Appendix A is a guide to the remote operation of the HP 8340A/8757A based system. Included in this section are a description of the function of the 8757 SYSTEM INTERFACE, the system connections for remote operation, and a modified sample program to demonstrate some of the capabilities of the HP 8340A/8757A based system.

### Reference Information

Complete reference information on the HP 8757A scalar network analyzer can be found in the HP 8757A Operating and Service Manual (HP Part No. 08757-90001) the HP 8757A Quick Reference Guide (HP Part No. 5954-1508), and the HP 8757A Introductory Operating Guide (HP Part No. 5953-8868).

### HP 8757 SYSTEM INTERFACE

The HP 8757A Rear Panel has a control port called the 8757 SYSTEM INTERFACE. This connector is physically the same as that defined for the Hewlett-Packard Interface Bus, but is specifically used by the HP 8757A to directly control an HP-IB sweep oscillator (HP 8350B or 8340A) or an HP-IB plotter (HP 7470A or 7475A) through their respective HP-IB ports. Sweep oscillator or plotter HP-IB commands from a system controller (such as the HP 9826A) may be passed through the HP 8757A's HP-IB to the 8757 SYSTEM INTERFACE.

The transfer of commands and data is performed by first sending a Pass Through **PTd** command to the HP 8757A, where *d* is 19 decimal for passing through to the HP-IB sweep oscillator or 05 decimal for passing through to the HP-IB plotter.

Subsequent addressing of the 8757 SYSTEM INTERFACE address will pass through commands to the instrument selected. The **PTd** command may be sent at any time.

The address of the 8757 SYSTEM INTERFACE is determined by complementing the least significant bit of the current HP 8757A address. For example, since the HP 8757A default address is 16 decimal = 10000 binary, the default 8757 SYSTEM INTERFACE address is 17 decimal = 10001 binary. As another example, if the HP 8757A address is 7 decimal = 111 binary, then the SYSTEM INTERFACE address becomes 6 decimal = 110 binary.

An example of pass through commands to the HP-IB sweep oscillator with address 19 decimal using the default HP 8757A address is:

1. Address device 16 (the HP-IB of the HP 8757A); send the characters **PT19** or **PT19 [cr] [lf]**.
2. Address device 17 (the 8757 SYSTEM INTERFACE); send sweeper HP-IB commands.
3. Address device 16. This returns the HP 8757A to its normal HP-IB operation.

When the HP 8340A synthesized sweeper is connected to the 8757 SYSTEM INTERFACE and when the PRESET key on the HP 8757A is pressed or when the command **IP** is sent via the HP-IB the following conditions are initialized in the HP 8340A:

- a. Instrument Preset.
- b. Sweep time set to 200 ms.
- c. HP 8340A square wave input for scalar analyzer ( **[SHIFT] [PULSE]** ) ON.

### System Configuration

Set up the equipment as shown in Figure 6. Connect the controller (e.g. HP 9826A) to the HP-IB Connector on the rear panel of the HP 8757A. Then connect the HP 8340A to 8757 SYSTEM INTERFACE.

### Modified Sample Program

The following modified sample program shows a way of controlling the HP 8340A via the 8757 SYSTEM INTERFACE. The programming example is structured using the following format:

1. Each will refer to a sample program and explanation already given in the main operating guide.
2. A modified program listing.
3. An explanation of the modified or added lines of the program listing, and instructions for operating the system when necessary.

For more detail on the program refer to the main operating guide.

### Check Out

```
10 !HPIB TEST
20 S0=719
21 Sna=716
22 Sysint=717
23 S0=Sysint
24 OUTPUT Sna;"PT19"
30 ABORT 7
40 CLEAR Sna
50 PRINT "9826A is ACTIVE controller"
60 REMOTE Sna
70 DIM A$(1)
80 LINPUT "8340A/8757A SYSTEM is in REMOTE MODE",A$
90 REMOTE Sna
100 LOCAL LOCKOUT 7
110 LINPUT "LOCAL LOCKOUT MODE",A$
120 LOCAL 7
130 LINPUT "RETURN TO LOCAL",A$
140 OUTPUT Sna;"IP"
150 END
```

### Explanation of Modified or Added Lines

#### Lines

- 21:** Assign **Sna** to the HP 8757A scalar network analyzer address.
- 22:** Assign **Sysint** to the 8757 SYSTEM INTERFACE address.
- 23:** Assign **S0** to **Sysint** (=717) and data will be transferred via 8757 SYSTEM INTERFACE to the HP 8340A synthesized sweeper.
- 24:** Send a Pass Through "**PT19**" command to the HP 8757A scalar network analyzer, where "19" is the address of the HP 8340A synthesized sweeper.
- 40:** Clear all status bytes, the Request Mask, the HP-IB of the HP 8757A and the 8757 SYSTEM INTERFACE.
- 60-90:** Put the HP 8757A/8340A system in **REMOTE** mode and display a message to the user.
- 140:** Set the HP 8757A/8340A system to a predefined state via Instrument Preset.

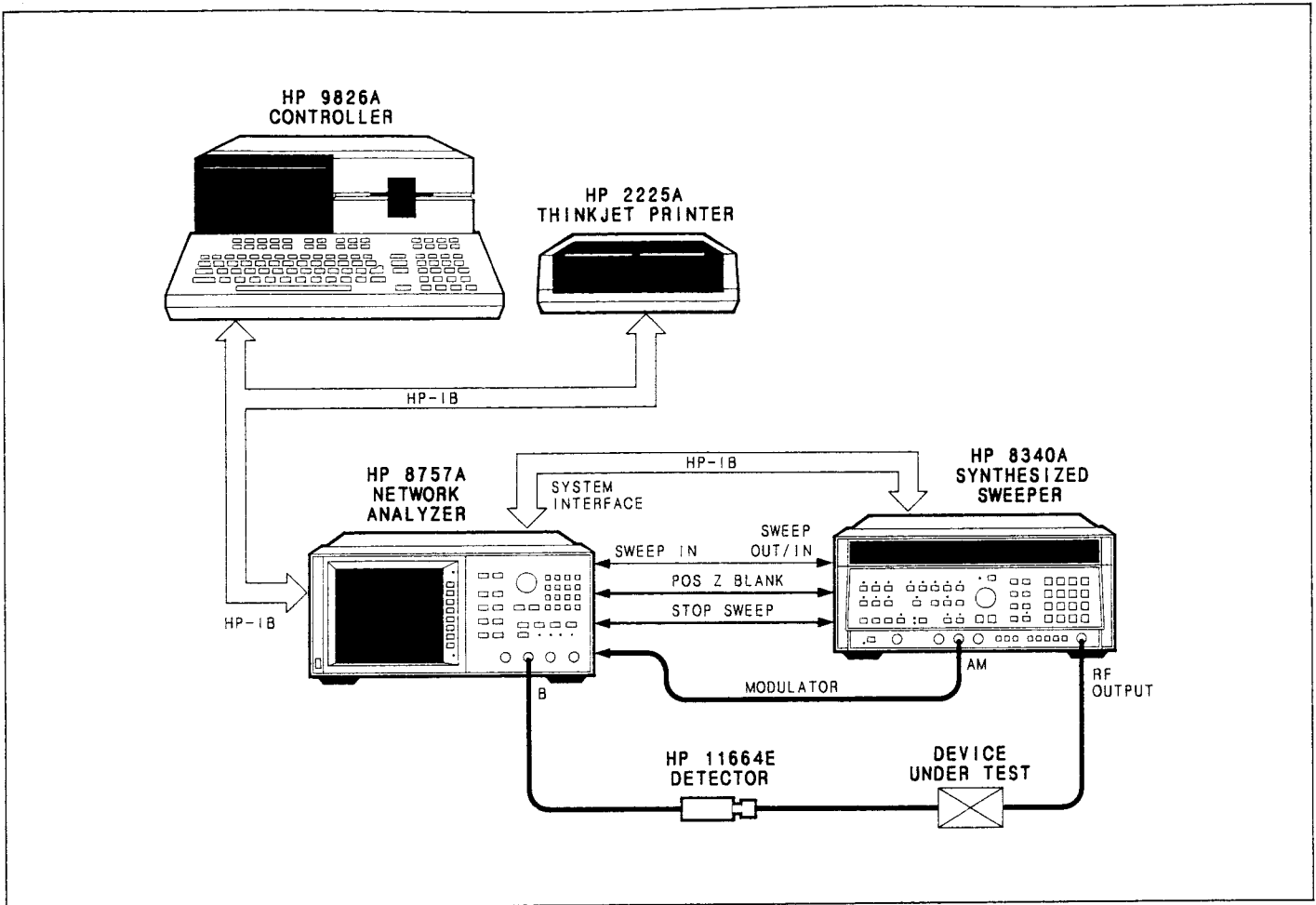

Figure 6. Equipment Setup

To verify and investigate the different remote modes do the following:

1. Press **[SHIFT] [PAUSE]** to reset the HP 9826A.
2. Press **[SHIFT] [CLR LN]** and **[RUN]** on the HP 9826A.
3. With the HP 9826A displaying "ACTIVE CONTROLLER" and "REMOTE" messages, verify that the HP 8340A/8757A System REMOTE lights are lit. From the front panel, attempt to change the start frequency and verify that this is impossible. Verify that the INSTRUMENT PRESET key and all other keys except LOCAL are disabled. Since the HP 8757A controls the HP 8340A synthesized sweeper via the 8757 SYSTEM INTERFACE, only the HP 8757A LOCAL key can put the HP 8340A/8757A system in LOCAL mode. Now press the LOCAL key on the HP 8757A and verify that the REMOTE lights on both the HP 8340A and 8757A are off and that you can modify any of the HP 8340A or the HP 8757A functions.
4. Press **[CONTINUE]** on the HP 9826A. With the HP 9826A displaying "LOCAL LOCKOUT MODE" verify that the HP 8340A/8757A system REMOTE lights are again lit. Again attempt to change the start frequency and perform an Instrument Preset. Verify that this is impossible. Now press the HP 8757A LOCAL key and verify that still no action is taken.
5. Press **[CONTINUE]** on the HP 9826A. With the HP 9826A displaying "RETURN TO LOCAL", verify that the HP 8340A/8757A REMOTE lights are off. Also verify that all functions now can be modified via the front panel controls.
6. Press **[CONTINUE]** on the HP 9826A. Verify that the HP 8340A/8757A system has undergone an Instrument Preset.

## Example Program 1: Setting up a typical sweep

```

10 !SETTING UP A SWEEP
20 S0=719
21 Sna=716
22 Sysint=717
23 S0=Sysint
24 OUTPUT Sna;"PT19"
30 PRINT CHR$(12)
31 OUTPUT Sna;"IPC10"
40 OUTPUT S0;"FA1.234GZFB5.678GZ"
41 OUTPUT Sna;"C2AS"
50 PRINT "START FREQUENCY is 1.234 GHz"
60 PRINT "STOP FREQUENCY is 5.678 GHz"
70 DISP "ENTER SWEEP TIME in msec";
80 INPUT T
90 PRINT "SWEEP TIME is ",T,"msec"
100 OUTPUT S0;"ST";T;"MS"
101 OUTPUT Sna
110 IMAGE "PL",SDD,"dB"
120 DISP "ENTER POWER LEVEL in dBm";
130 INPUT P
140 PRINT "POWER LEVEL is ",P,"dBm"
150 OUTPUT S0 USING 110;P
151 OUTPUT Sna;"C2AS"
160 DIM A$(1)
170 LINPUT "PRESS CONTINUE",A$
180 IMAGE "M1",K,"GZ"
190 OUTPUT S0 USING 180;3.5
200 OUTPUT S0;"M24.666GZ"
201 OUTPUT Sna
210 PRINT "MARKER No 1 is 3.5 GHz"
220 PRINT "MARKER No 2 is 4.666 GHz"
230 LINPUT "SETTING COMPLETED",A$
240 OUTPUT S0;"SV1"
241 OUTPUT Sna;"IP"
250 PRINT "SETTING STORED IN REGISTER 1"
260 WAIT 3
270 OUTPUT S0;"RC1"
271 OUTPUT Sna;"C1C0C2AS"
280 END

```

## Explanation of Modified or Added Lines

### Lines

- 21:** Assign **Sna** to the HP 8757A scalar network analyzer address.
- 22:** Assign **Sysint** to the 8757 SYSTEM INTERFACE address.
- 23:** Assign **S0** to **Sysint** (=717) and data will be transferred via 8757 SYSTEM INTERFACE to the HP 8340A synthesized sweeper.
- 24:** Send a Pass Through "**PT19**" command to the HP 8757A scalar network analyzer, where "19" is the address of the HP 8340A synthesized sweeper.
- 31:** Set the HP 8757A/8340A system to a predefined state via Instrument Present and turn channel 1 of the HP 8757A OFF.
- 41, 151:** Autoscale channel 2 of the HP 8757A.
- 101, 201:** Address the HP 8757A to return the scalar network analyzer from Pass Through mode to its normal HP-IB operation.
- 241:** Set the HP 8757A/8340A system to a pre-defined state via Instrument Preset.
- 271:** Turn channel 1 OFF and autoscale channel 2 on the HP 8757A.

The statement in line 240 saves the HP 8340A synthesized sweeper settings in Register 1, and line 270 recalls the saved settings of Register 1. If you desire to save both the HP 8340A and 8757A settings, then lines 240 and 270 should be modified as follows:

**240 OUTPUT Sna,"SV1"**

**270 OUTPUT Sna "RC1"**







# Programming Note

8340A/0000-3  
Supersedes: 8340A/0000-2A

AUGUST 1983

## Quick Reference Guide for the HP 8340A Synthesized Sweeper

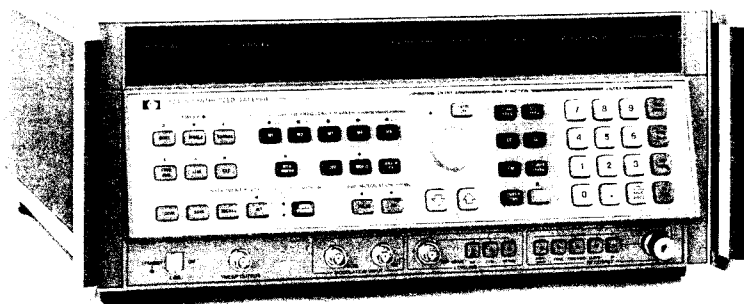

### INTRODUCTION

This programming note is a reference guide for the remote operation of the HP 8340A Synthesized Sweeper. This note is intended for use by those familiar with HP-IB programming and the basic functions of the HP 8340A. For complete programming information refer to the HP 8340A Operating and Service manual.

### HP-IB CAPABILITIES

The following codes describe the HP-IB electrical capabilities of the HP 8340A, using IEEE Std 488-1978 mnemonics (HP-IB, GP-IB, IEEE 488, and IEC-625 are all electrically equivalent). Briefly, the mnemonics translate as follows:

- SH1:** Source Handshake, complete capability.
- AH1:** Acceptor Handshake, complete capability.
- T6:** Talker, capable of basic talker, serial poll, and unaddress if MLA.
- TE0:** Talker, Extended address; no capability.
- L4:** Listener, capable of basic listener, and unaddress if MTA.
- LE0:** Listener, Extended address; no capability.

**SR1:** Service Request, complete capability.

**RL1:** Remote Local, complete capability.

**PP0:** Parallel Poll, no capability.

**DC1:** Device Clear, complete capability.

**DT1:** Device Trigger, complete capability.

**C0, 1, 2, 3, 28:** Controller capability options; C0, no capabilities; C1, system controller; C2, send IFC and take charge; C3, send REN; C28, send I.F. messages.

**E1:** Electrical specification indicating open collector outputs.

These codes are completely explained in the **IEEE Std 488-1978** document, published by The Institute of Electrical and Electronic Engineers, Inc., 345 East 47th Street, New York, New York 11017.

### INPUT DATA

The 8340A Synthesized Sweeper accepts programming codes that contain information for programming all of the front panel and special HP-IB only functions except

except the Line switch and Set HP-IB Address. Programming data consists of a string of ASCII coded characters composed of one or more of the following control fields:

- Sweep Mode/Limits
- Frequency Markers
- Sweep Mode, Trigger, and Time
- Modulation
- Step Size, Display, and Entry Control
- Instrument State/Registers
- Power Level and Control
- Special HP-IB Only Functions
- Diagnostic Functions

### INPUT SYNTAX

The 8340A responds to program codes in the order in which they are received. Each function is programmed with a string of ASCII coded characters that follow one of these sequences:

- [Function Code] [Numeric Value] [Numeric Terminator]
- [Function Code]

### NOTE

**The HP-IB program code sequence typically mirrors that of the local front panel keystroke sequence.**

### FUNCTION CODES (PREFIX ACTIVATE)

Function codes are typically 2 to 4 character mnemonics. For functions that have a numeric value associated with them, passing the function code only will enable and activate the function for further data entry.

### NUMERIC VALUE (NUMERIC FORMAT)

These are either a single decimal digit, a set of 14 characters or less representing a number, or a string of binary bytes. A string of 14 characters maximum can be expressed in exponential, decimal or integer form. Acceptable numeric formats are referenced in later sections by the following format syntax:

- Format #1: Exponential  $\pm d^{***}d.d^{***}dE \pm dd$
- Format #2: Decimal  $\pm d^{***}d.d^{***}d$
- Format #3: Integer  $\pm d^{***}d$
- Format #4: Single Digit  $d$
- Format #5: Binary String  $b^{***}b$
- Format #6: Binary Byte  $b$

Where the character 'd' indicates a leading or trailing zero, a space, or a numeric digit (0 through 9). The character 'b' indicates an 8-bit binary byte. The characters '\*\*\*' indicate a variable number of the

previous character. Numeric values that are not binary in nature are scaled by the appropriate numeric terminator.

### NUMERIC TERMINATORS

Numeric terminators are of 2 types, mnemonic and fundamental terminators. Mnemonic terminators are 2-character codes that terminate and scale the associated numeric value. Thus, frequency values can be entered in GHz (GZ), MHz (MZ), kHz (KZ), or Hz (HZ); sweep time values can be entered in seconds (SC) or milliseconds (MS) and power values can be entered in dB or dBm (both DB). Fundamental terminators consist of the ASCII characters Line Feed or Next Line (LF or NL, decimal 10), semicolon (;, decimal 59), or comma (',, decimal 44), and may be used in lieu of a mnemonic terminator. However, when this is done the 8340A assumes the numeric value is in the fundamental units of Hz, seconds or dB.

### VALID CHARACTERS

The alpha program codes can be either upper or lower case since the 8340A will accept either type (they can be interchanged). Spaces, unnecessary signs (+, -), leading zeroes and carriage returns (CR) are ignored. Characters containing a parity bit will have that bit cleared by the 8340A.

### PROGRAMMING DATA

See Table 1 for Input Programming Codes.

### NOTE

**If different step attenuator settings exist between the foreground and background states of an Alternate Sweep, the 8340A will perform the Alternate Sweep function, but the step attenuator will not vary from the foreground state in order to avoid excessive attenuator wear.**

### INSTRUMENT PRESET

Instrument Preset turns off all functions then sets the following:

Sweep Mode: Start/Stop  
 Start = 10 MHz  
 Stop = 26.5 GHz

Sweep: Continuous

Trigger: Free Run

Sweep Time = 44.15 ms (minimum for full band)

Markers: All values set to center of frequency span, all off

Table 1. Input Programming Codes (1 of 6)

MODE	FUNCTION	PROGRAM CODE				NUMERIC VALUE		
		PREFIX ACTIVATE	NUMERIC FORMAT	SUFFIX	SCALE FACTOR	RANGE	RESOLUTION	
<b>SWEEP MODE/LIMITS</b>								
Start/Stop Sweep	START	FA	1,2,3,4	GZ	$\times 10^9$ Hz	10 MHz to 26.4999999 GHz	Greater than 0.1% of current $\Delta F$	
	STOP	FB				10.0001 MHz to 26.5 GHz		
Center Frequency/ $\Delta F$ Sweep	CF	CF		MZ	$\times 10^6$ Hz	10.00005 MHz to 26.49999995 GHz	Greater than 0.1% of current $\Delta F$	
	$\Delta F$	DF		KZ	$\times 10^3$ Hz	100 Hz to 26.49 GHz		
	ZOOM	SHST				10.00005 MHz to 26.49999995 GHz		
CW Frequency	CW	CW			HZ	$\times 1$ Hz	10 MHz to 26.5 GHz	1 to 4 Hz, depending on frequency range
	CW RESOLUTION	SHCW						
<b>FREQUENCY MARKERS</b>								
Turn On And Set Marker Frequency	MARKER 1	M1	1,2,3,4	GZ	$\times 10^9$ Hz	10 MHz to 26.5 GHz	Greater than 0.1% of Current $\Delta F$	
	MARKER 2	M2		MZ	$\times 10^6$ Hz			
	MARKER 3	M3		KZ	$\times 10^3$ Hz			
	MARKER 4	M4		HZ	$\times 1$ Hz			
	MARKER 5	M5						
Turn Off A Frequency Marker	M1 OFF	M1		M0				
	M2 OFF	M2						
	M3 OFF	M3						
	M4 OFF	M4						
	M5 OFF	M5						
Turn Off All Markers	ALL OFF	SHM0						
Turn On And Set Mkr $\Delta$	MKR $\Delta$ , Marker "m", Marker "n"	MD1	MmMn			Where: m,n: 1 to 5		
Turn Off Mkr $\Delta$	MKR $\Delta$ OFF	MD0						
Active Marker To Center Frequency	MKR $\rightarrow$ CF	MC						
Marker 1-2 Sweep	MKR SWEEP ON	MP1						
	MKR SWEEP OFF	MP0						
Marker 1 to Start Marker 2 to Stop	M1 $\rightarrow$ START M2 $\rightarrow$ STOP	SHMP						

Table 1. Input Programming Codes (2 of 6)

MODE	FUNCTION	PROGRAM CODE			NUMERIC VALUE		
		PREFIX ACTIVATE	NUMERIC FORMAT	SUFFIX	SCALE FACTOR	RANGE	RESOLUTION
<b>FREQUENCY MARKERS (Cont'd)</b>							
Amplitude Frequency Markers	AMPTD MKR ON	AK1					
	AMPTD MKR OFF	AK0					
<b>SWEEP MODE, TRIGGER, AND TIME</b>							
Sweep Mode	CONTINUOUS	S1					
	SINGLE	S2 or SG					
	MANUAL FREQUENCY SWEEP	S3 or SM	1,2,3,4	GZ	$\times 10^9$ Hz	Present Start/Stop Frequencies	1-4 Hz Depending On Frequency Range
				MZ	$\times 10^6$ Hz		
			KZ	$\times 10^3$ Hz			
			HZ	$\times 1$ Hz			
Sweep Trigger	FREE RUN	T1					
	LINE	T2					
	EXTERNAL	T3					
Sweep Time	SWEEP TIME	ST	1,2,3,4	SC	$\times 1$ sec	0.01 to 200 sec	Greater Than 0.1% Of Current Sweep Time
				MS	$\times 10^{-3}$ sec		
<b>MODULATION</b>							
Amplitude Modulation	AM ON	AM1					
	AM OFF	AM0					
Pulse Modulation	PULSE MOD. ON	PM1					
	PULSE MOD. OFF	PM0					
	INCREASE ALC BANDWIDTH IN PULSE MODE	SHAM					
	DISABLE ALC TO CONTROL MODULATOR DRIVE DIRECTLY	SHA3					
<b>STEP SIZE, DISPLAY, AND ENTRY CONTROL</b>							
Set Frequency Step Size	FREQUENCY STEP SIZE	SF or SHCF	1,2,3,4	GZ MZ KZ HZ	$\times 10^9$ Hz $\times 10^6$ Hz $\times 10^3$ Hz $\times 1$ Hz	1 Hz to 10 GHz	1-4 Hz Depending On Frequency Range
Set Power Step Size	POWER STEP SIZE	SP or SHPL	1,2,3,4	DB	$\times 1$ dB	0.05 dB to 50 dB	0.05 dB
Increment Active Parameter <sup>2</sup>	STEP UP ↑	UP					
Decrement Active Parameter-	STEP DOWN ↓	DN					
Numeric Display Update	DISABLE DISPLAY UPDATE	SHS10 or DU0					
	RE-ENABLE DISPLAY UPDATE	SHS11 or DU1					

Table 1. Input Programming Codes (3 of 6)

MODE	FUNCTION	PROGRAM CODE			NUMERIC VALUE		
		PREFIX ACTIVATE	NUMERIC FORMAT	SUFFIX	SCALE FACTOR	RANGE	RESOLUTION
<b>STEP SIZE, DISPLAY, AND ENTRY CONTROL (Cont'd)</b>							
X-Y Recorder Interface <sup>3</sup>	ENABLE PENLIFT AT BANDCROSSING	SHT21					
	DISABLE PENLIFT AT BANDCROSSING	SHT20					
Fixed Function To Coupled Mode	AUTO	AU					
Disable Active Function	ENTRY OFF	EF					
Display Scale	MULTIPLICATION FACTOR	SHFA	1,2,3,4		× 1	- 30 to + 30	
Display Offset	OFFSET FACTOR	SHFB	1,2,3,4	GZ MZ KZ HZ	× 10 <sup>9</sup> Hz × 10 <sup>6</sup> Hz × 10 <sup>3</sup> Hz × 1 Hz	- 500 GHz to 500 GHz	1 HZ
2. In CW RES mode, step keys change resolution. In ZOOM, step keys change ΔF. When attenuator and ALC loop are decoupled, step keys change attenuator in 10 dB steps. 3. Valid only when sweep time is ≥5 seconds.							
<b>INSTRUMENT STATE/REGISTERS</b>							
Instrument Preset	INSTR PRESET	IP					
Save An Instrument State	SAVE n	SV	4		× 1	Registers 1 through 9 <sup>4</sup>	
Recall An Instrument State	RECALL n	RC					
Lock Registers	SAVE LOCK	SHSV					
Unlock Registers	SAVE UNLOCK	SHRC					
Alternate Sweep Mode	ALT ON	AL1	4		× 1	Registers 1 through 9	
	ALT OFF	AL0					
4. Register 0 contains the previous instrument state and can be recalled. However, SAVE 0 is not allowed.							
<b>POWER LEVEL AND CONTROL</b>							
Set Output Power Level	POWER LEVEL	PL	1,2,3,4	DB	× 1 dBm	20 dBm to - 90 dBm	0.05 dB
Power Sweep Mode	POWER SWEEP ON	PS1	1,2,3,4	DB	× 1 dB/Swp	0 to 40.0 dB/Swp	0.05 dB
	POWER SWEEP OFF	PS0					
Power Slope Mode	SLOPE ON	SL1	1,2,3,4	DB	× 1 dB/GHz	0 to 1.5 dB/GHz	0.001 dB
	SLOPE OFF	SL0					
RF Power	RF ON	RF1					
	RF OFF	RF0					
Peak Output Power (CV Mode or Manual Sweep)	PEAK ON	RP1					
	PEAK OFF	RP0					

Table 1. Input Programming Codes (4 of 6)

MODE	FUNCTION	PROGRAM CODE			NUMERIC VALUE		
		PREFIX ACTIVATE	NUMERIC FORMAT	SUFFIX	SCALE FACTOR	RANGE	RESOLUTION
<b>POWER LEVEL AND CONTROL (Cont'd)</b>							
Instantaneous Peak	FAST PEAKING	SHAK					
Peak Output Power (Swept Mode)	AUTO TRACKING CALIBRATION	SHRP					
Leveling Modes	INTERNAL	A1					
	EXTERNAL <sup>5</sup> CRYSTAL	A2	1,2,3,4	DB	×1 dBv	-70 dBv to +10 dBv	0.05dB
	EXTERNAL <sup>5</sup> POWER METER	A3					
Independent <sup>6</sup> Control of ALC and Attenuator	DECOUPLE ALC AND ATTENUATOR	SHPS					
	CONTROL ALC INDEPENDENTLY	SHPS	1,2,3,4	DB	×1 dB	20 dBm to -20 dBm	0.05 dB
	CONTROL STEP ATTENUATOR INDEPENDENTLY	SHSL or AT	3	DB	×1 dB	-10 dB to -90 dB in 10 dB Steps	10 dB
	RE-COUPLE ALC AND ATTENUATOR	PL <sup>7</sup>					
5. Attenuator and ALC are automatically decoupled in this mode. ALC value is in dBv and is adjusted as shown. Attenuator may be adjusted using "AT" or "SHSL" commands as shown in this table. 6. INT mode only. Decoupling occurs automatically in XTAL and METER Modes. 7. Power output retains same level as last value in decoupled mode.							
<b>SPECIAL HP-IB ONLY FUNCTIONS</b>							
Status Bytes And Service Requests	OUTPUT STATUS	OS					
	STATUS BYTE MASK	RM	6			1 byte	
	EXTENDED STATUS BYTE MASK	RE	6			1 byte	
	CLEAR STATUS BYTE	CS					
Learn String	OUTPUT LEARN STRING	OL					
	INPUT LEARN STRING	IL	5			123 bytes	
Mode String	OUTPUT MODE STRING	OM	5			8 bytes	
Output Interrogated Parameter Value	OUTPUT INTERROGATED VALUE	OP		Interrogated Parameter Code			
Output Active Parameter Value	OUTPUT ACTIVE VALUE	OA					
Output Power Level	OUTPUT POWER LEVEL	OR					
Output Diagnostic Numbers	OUTPUT DIAGNOSTICS	OD					
Output Fault	OUTPUT FAULT	OF					

Table 1. Input Programming Codes (5 of 6)

MODE	FUNCTION	PROGRAM CODE			NUMERIC VALUE		
		PREFIX ACTIVATE	NUMERIC FORMAT	SUFFIX	SCALE FACTOR	RANGE	RESOLUTION
<b>SPECIAL HP-IB ONLY FUNCTIONS (Cont'd)</b>							
Output Coupled Parameters	OUTPUT COUPLED PARAMETERS	OC					
Output Last Lock Frequency	OUTPUT LAST LOCK FREQUENCY	OK					
Output Next Bandcross Frequency	OUTPUT NEXT BANDCROSS	OB					
Outputs Model Number & Software Rev Date	OUTPUT IDENTIFY	OI					
Sweep Functions	STEPPED SWEEP	SN	1,2,3,4		× 1	10 to 1000	
	TIME LIMIT	TL	1,2,3,4	SC MS	× 1 sec × 10 <sup>-1</sup> sec	.01 to 40 sec	.001 sec
Fast Phaselock	FAST PHASELOCK SELECT	FP					
Single Sweep Start/Stop	RESET SWEEP	RS					
	TAKE SWEEP	TS					
Increment Frequency By Frequency Step Size	INCREMENT FREQUENCY	IF <sup>a</sup>					
Enable Control Knob	ENABLE KNOB	EK					
Control Knob Remotely	RPG BYTE	RB	6			1 byte	
Alternate State Selection	SELECT CURRENT FRONT PANEL	AS0					
	SELECT RECALLED STATE	AS1					
Network Analyzer Functions	NETWORK ANALYZER CONFIGURE	NA	6			1 byte	
	ADVANCE TO NEXT BANDCROSSING	BC					
	KEYBOARD RELEASE	KR					
	SWAP CHANNELS	SW0 SW1					
Test HP-IB Interface	TEST INTERFACE	TI	6			1 byte	
8. CW and MANUAL modes only. Frequency need not be the active function to utilize this command.							
<b>DIAGNOSTIC FUNCTIONS</b>							
Display M-N and 20/30 Loop Frequencies	DISPLAY M, N, M-N FREQ., 20/30 FREQ	SHM1					
Display Band # And Y-O Loop Frequency	DISPLAY BAND # AND Y-O FREQ	SHM2					
Display VCO1 And VCO2 Frequencies	DISPLAY VCO1 AND VCO2	SHM3					

Table 1. Input Programming Codes (6 of 6)

MODE	FUNCTION	PROGRAM CODE				NUMERIC VALUE	
		PREFIX ACTIVATE	NUMERIC FORMAT	SUFFIX	SCALE FACTOR	RANGE	RESOLUTION
<b>DIAGNOSTIC FUNCTIONS (Cont'd)</b>							
Front Panel Display Test	DISPLAY TEST	SHT1					
Display Unlock Indicators	DISPLAY UNLOCK INDICATORS	SHT3					
Display Fault Indicators	DISPLAY FAULT INDICATORS	SHS3					
Band Cross Control	DISABLE BAND CROSS	SHA21					
	RE-ENABLE BAND CROSS	SHA20					
Cause Manual Band Cross	MANUAL BAND CROSS	SHA1 or BC					
Turn Off Diagnostic Displays	DIAGNOSTICS OFF	SHM5					

Modulation: Off

Frequency Step Size: Set to default value (10% of span)

Status Bytes: Cleared

Leveling: Internal

RF Output: On

Power Level = 0 dBm

Power Step Size: Set to default value (10 dB)

Power Sweep/Slope: Set to 0 dB

Storage Registers: Retain current values

HP-IB Address: Retains current value

Status Byte Mask: Unchanged

Extended Status Byte Mask: Unchanged

### OUTPUT DATA

The 8340A has several output modes that allow the user to learn and interrogate the present instrument state. These output modes and their usage are shown in Table 2, and the program codes and syntax to enable each function are shown in Table 1.

The Learn String, Mode String, and Status functions send a Data message consisting of a string of 8-bit binary bytes. These messages are terminated by asserting the bus EOI signal in parallel with the last byte of the message to be sent. The other functions send a Data message consisting of up to 14 character ASCII

strings representing the numeric value in exponential form terminated with a Line Feed or Next Line (i.e. LF = NL = decimal 10).

Binary Syntax: [b\*\*\*b] [EOI]

Numeric Syntax: [ $\pm$ d.dddddE  $\pm$ dd] [LF]

The character 'b' indicates an 8-bit binary byte and 'd' indicates a decimal digit (0 through 9). Note that the binary output format could have bytes that may be misinterpreted as Line Feeds so the user should defeat the ASCII LF as a valid character string terminator and rely on the byte count.

### TRIGGER

The 8340A responds to HP-IB commands Group Execute Trigger (GET) and Selective Device Trigger (SDT) identically. The specific response is dictated by the current mode of the instrument. The 8340A determines this mode by a series of tests performed in the order below. Note that once the 8340A sees that it is in a certain mode it will perform the appropriate function and no other.

**First test:** If the 8340A is in the FAST PHASE LOCK (FP) mode the current frequency will be incremented by the frequency step.

**Second test:** If the 8340A is in the NETWORK ANALYZER (NA) mode and it is in the middle of a sweep it will immediately initiate a new sweep. If it is in the NA mode and it is not in the middle of a sweep



Table 2. Output Modes

MODE	PRO-GRAMMING CODE	DESCRIPTION	FORMAT	NOTES
Output Learn String	OL	Outputs binary data string 123 bytes long which completely describes instrument state. Can be stored in ASCII character data string and later input to 8340A to restore that instrument state. (See "IL" command.)	123[8 bytes][EOI]	String does not include storage register contents. Information is packed, so data analysis is difficult. Learn string length is fixed.
Output Mode String	OM	Outputs binary string 10 bytes long. First bytes describe all presently active 8340A functions. Last byte tells which function is currently active (i.e., shown in entry display). String only tells which functions are active; does not give numeric values.	10[8 bit bytes][EOI]	Information in first bytes is packed. Mode string length is fixed. If numeric values desired, use "OA" or "OP" modes (see below).
Output Interrogated Parameter Value	OP [Function code]	Outputs the present numeric value of function selected.	[± d.dddddE ± dd][LF]	Output data in Hz, dBm, dB, or sec., implied by function selected.
Output Active Parameter Value	OA	Outputs present numeric value of currently active function (i.e., shown in <b>ENTRY DISPLAY</b> ).	[± d.dddddE ± dd][LF]	Output data in Hz, dBm, dB, or sec., implied by function selected.
Output Status	OS	Outputs 2 sequential 8-bit bytes giving present 8340A status. First Status Byte equivalent to that of Serial Poll, second is Extended Status Byte.	2[8 bit bytes][EOI]	Table 3 describes both status bytes. Status bytes cleared by Serial Poll, SPD, DCL, "CS" command, Instrument Preset, or Power On
Output Power	OR	Outputs value currently displayed in <b>POWER dBm</b> display of 8340A.	[± d.dddddE ± dd][LF]	Output data in dBm. Value in <b>POWER dBm</b> display is always read regardless of leveling mode.
Output Diagnostic Numbers	OD	Outputs diagnostic numbers shown in 8340A display after one of the diagnostic functions SHM1, SHM2, or SHM3 has been activated.	m[± d.dddddE ± dd][LF]	m = 4 for SHM1 m = 2 for SHM2, SHM3 M, N, and Band number are output as dimensionless quantities; all other data output in Hz.
Output Fault	OF	Outputs in ASCII form a number which can be decoded to determine locations which have caused the FAULT or UNLK annunciators to come on.	[± d.dddddE ± dd][LF]	Conditions are accumulated by 8340A and cleared only by Power On, Instrument Preset, or "OF" command.
Output Last Lock Frequency	OK	Outputs the frequency to which 8340A most recently phase-locked.	[± d.dddddE ± dd][LF]	Output data in Hz.
Output Coupled Parameters	OC	Outputs (in order): Start frequency, center frequency, and sweep time.	3[± d.dddddE ± dd][LF]	Output data in Hz and sec.
Output Next Bandcross Frequency	OB	Outputs the frequency which begins the next frequency band the 8340A would enter if it continues to sweep after the command is received.	[± d.dddddE ± dd][LF]	Output data in Hz.
Output Identification	OI	Outputs the revision date of the firmware currently loaded in the 8340A.	08340AREV day month year	19 ASCII characters: 2 numbers for the day, 3 letters for the month and 2 numbers for the year.

then no operation will be performed.

**Third test:** If the 8340A is in the CW (CW) or MANUAL SWEEP (SM or S3) mode an Increment Frequency (IF) operation will be performed.

**Fourth test:** If the 8340A is in the middle of a sweep the sweep will be aborted and will restart a new sweep.

**Fifth test:** Finally, if the 8340A is in the SINGLE SWEEP (S2) mode it will start a new sweep.

### CLEAR

The 8340A responds to both Device Clear (DCL) and Selective Device Clear (SDC) by clearing both status bytes and initializing the interface so that it is ready to receive HP-IB programming codes. This is necessary if the instrument state prior to sending HP-IB commands is unknown. It is good practice to execute DCL or SDC at the beginning of any program.

### REMOTE/LOCAL CHANGES

The 8340A goes to the Remote state when the REN line is true (low) and the 8340A receives its listen address. In Remote, all front panel functions are disabled except the LINE switch and the LOCAL key. The LOCAL function can also be disabled via the Local Lockout (LLO) command.

The 8340A goes to the Local state when it receives the Go To Local (GTL) command or when the REN line is set false (high). If the Local Lockout (LLO) command has not been executed, the 8340A can also be set to Local by pressing the LOCAL key. In Local, the front panel is active but the instrument will still respond to HP-IB programming codes.

### SERVICE REQUEST

The 8340A can initiate a Service Request (SRQ) whenever one of the following conditions exists:

- New frequencies or sweep time in effect
- Error in syntax
- End of sweep
- Phase lock sequence completed (RF settled)
- Change in Extended Status Byte bit(s)
- Numeric entry complete
- Front panel key pressed

Further information can be obtained by conducting a Serial Poll or by executing the Output Status command, both of which access Status Byte information. The SRQ is cleared only by executing a Serial

Poll. To select an SRQ for a particular set of circumstances, the Request Mask function can be used to determine which of the bits in the first Status Byte can cause an SRQ. The mask value is determined by summing the decimal values of each selected function/condition that is desired. The default Request Mask at power on is '00000000' or decimal 0. This mask value is reset to the default value only at power on or by execution of the DCL or SDC commands.

### STATUS BYTE

The 8340A responds to a Serial Poll by sending its status byte as indicated in Table 3. The Extended Status Byte is available but must be accessed via the Output Status command. When Bit 6 (Request Service) of the Status Byte is true (one), an SRQ has occurred. See **Service Request** for the conditions causing a Service request. Bit 2 indicates whether a change has occurred in the Extended Status Byte. If Bit 2 is true, then the second status byte should be accessed via the Output Status command to determine the cause of the status change. All other bits (7, 5, 4, 3, 1, 0) indicate the present status of the noted function. The bits are true (one) if and only if the associated function/condition is true.

### STATUS BIT

The 8340A does not respond to a Parallel Poll.

### CONTROLLER CAPABILITIES

The 8340A does not have the ability to take or pass control.

### ABORT

The 8340A responds to the Abort message (Interface Clear — IFC true) by stopping all Listener or Talker functions.

### ADDRESS ASSIGNMENT INFORMATION

The 8340A basic address is factory preset to decimal 19. In the Local mode, this address can be changed from the front panel by pressing the SHIFT and then the LOCAL keys. ENTRY DISPLAY will show the current address; a new one can be entered via the 8340A keyboard. The new address will remain until changed by the operator.

Table 3. 8340A Status Byte Descriptions

STATUS BYTE (#1)								
BIT #	7	6	5	4	3	2	1	0
DECIMAL VALUE	128	64	32	16	8	4	2	1
FUNCTION	SRQ on New frequencies or Sweep Time in Effect	REQUEST SERVICE (RQS)	SRQ on HP-IB Syntax Error	SRQ on End of Sweep	SRQ on RF Settled	SRQ on Change in Extended Status Byte	SRQ on Numeric Entry Completed (HP-IB or Front Panel)	SRQ on Any Front Panel Key Pressed
EXTENDED STATUS BYTE (#2)								
BIT #	7	6	5	4	3	2	1	0
DECIMAL VALUE	128	64	32	16	8	4	2	1
FUNCTION	Fault Indicator On	RF Unleveled	Power Failure	RF Unlocked	External Freq. Ref. Selected	Oven Cold	Over Modulation	Self Test Failed



## SECTION IV

### PERFORMANCE TESTS

#### 4-1. INTRODUCTION

4-2. The procedures in this section and the following section (Automated Test Procedures) test the HP 8341A's electrical performance using the specifications of Table 1-1 as the performance standards. All tests can be performed without access to the interior of the instrument. An HP-IB Operation Verification procedure is also provided at the end of this section to verify proper HP-IB operation of the instrument.

#### NOTE

**The Automated Test Procedures provided include additional tests that would be impossible or too tedious to test with a manual procedure (Frequency Switching Time and RF Attenuator Performance). The automated tests also include several tests that allow adjustments to be made or calibration constants to be accessed or changed.**

#### 4-3. EQUIPMENT REQUIRED

4-4. Equipment required for the manual Performance Test Procedures documented in this section is listed in the Recommended Test Equipment table in Section I of this manual.

Any equipment that satisfies the critical specifications given the table may be substituted for the recommended model listed. Additional test equipment required for the Automated Performance Tests is included in that section (following this section) as well as in the Recommended Test Equipment List in Section I.

#### 4-5. TEST RECORD

4-6. Results of the manual Performance Test procedures may be tabulated on the test record card located at the end of this section. Results of the Automated Test Procedures are tabulated automatically at the end of each procedure. A complete test record card consists of the manual and automatic test results. Each test lists all of the tested specifications and their acceptable limits. The results recorded at incoming inspection can be used for comparison in periodic maintenance and troubleshooting and after repairs or adjustments have been made. Refer to the Automated Test Procedures section for more detailed information on how to access the data included in those tests.

#### 4-7. CALIBRATION CYCLE

4-8. This instrument requires periodic verification of performance. The instrument should be checked using the following performance tests at least once every year.

Table 4-1. List of Manual Performance Tests<sup>1</sup>

Paragraph	Performance Test Title	Page
4-9	Internal Time Base Aging Rate	4-3
4-10	Frequency Range and CW Mode Accuracy	4-6
4-11	Sweep Time Accuracy	4-12
4-12	Swept Frequency Accuracy	4-14
4-13	Maximum Leveled Output Power and Power Accuracy	4-18
4-14	External Leveling	4-26
4-15	Spurious Signals Test (10 MHz to 20 GHz)	4-30
4-17	Single Sideband Phase Noise	4-36
4-18	Power Sweep Test	4-43
4-19	Pulse Modulation ON/OFF Ratio Test	4-46
4-20	Pulse Modulation Rise and Fall Time Test	4-48
4-21	Pulse Modulation Accuracy Test	4-52
4-22	Pulse Modulation Video Feedthrough Test	4-56
4-23	Amplitude Modulation Test	4-60
4-24 <sup>2</sup>	HP-IB Operation Verification Test	4-65

1. This list does not include the automated tests for Frequency Switching Time and RF Attenuator Performance, each of which are also required to complete the performance testing of the HP 8341A.

2. This is not a Performance Test. It is included as an additional aid to determine that the HP-IB circuitry is operating properly.

**4-9. INTERNAL TIME BASE AGING RATE**

**NOTE**

The overall accuracy of the HP 8341A 10 MHz internal time base is a function of time base calibration  $\pm$  aging rate  $\pm$  temperature effects  $\pm$  line effects.

For greatest frequency accuracy, the time base should be allowed to warm up until the output frequency has stabilized (usually 7 to 30 days) before calibrating (adjusting the time base frequency to a known standard). After calibration, the change in time base frequency should remain within the aging rate if: the time base oven is not allowed to cool down, the instrument orientation with respect to the earth's magnetic field is maintained, and the instrument does not sustain any mechanical shock. Frequency changes due to orientation with respect to the earth's magnetic field and altitude changes will usually be nullified when the instrument is returned to its original position. Frequency changes due to mechanical shock will usually appear as a fixed frequency error.

If the instrument is disconnected from ac power allowing the time base oven to cool down, it may be necessary to readjust the time base frequency after a new warmup cycle; however, in most cases, the time base frequency will return to within  $\pm$  1 Hz of the original frequency.

**Specification**

*Table 4-2. Internal Time Base Aging Rate Specifications*

<p><b>Aging Rate:</b>  <math>1 \times 10^{-9}</math> per day, <math>2.5 \times 10^{-7}</math> per year after 72-hour warm up if HP 8341A has been disconnected from ac power for less than 24 hours. Aging rate is achieved after 7 to 30 days warm-up if HP 8341A has been disconnected from ac power for greater than 24 hours.</p> <p><b>Accuracy:</b>  Overall accuracy of internal time base is a function of time base calibration <math>\pm</math> aging rate <math>\pm</math> temperature effects <math>\pm</math> line effects.</p>
--

**Description**

A reference signal from the HP 8341A under test is connected to the oscilloscope's vertical input. A frequency standard (with long term stability greater than  $1 \times 10^{-10}$ ) is connected to the oscilloscope trigger input. The time required for a specific phase change is measured immediately and after a period of time. The aging rate is inversely proportional to the absolute value of the difference in the measured times.

**Equipment**

- Frequency Standard ..... HP 5061A
- Oscilloscope\* ..... HP 1741A

\* A 50 Ohm Feedthrough Termination (such as the HP 10100C) is required when using an oscilloscope without a 50 Ohm input. It is not required with the HP 1741A.

**4-9. INTERNAL TIME BASE AGING RATE (Cont'd)**

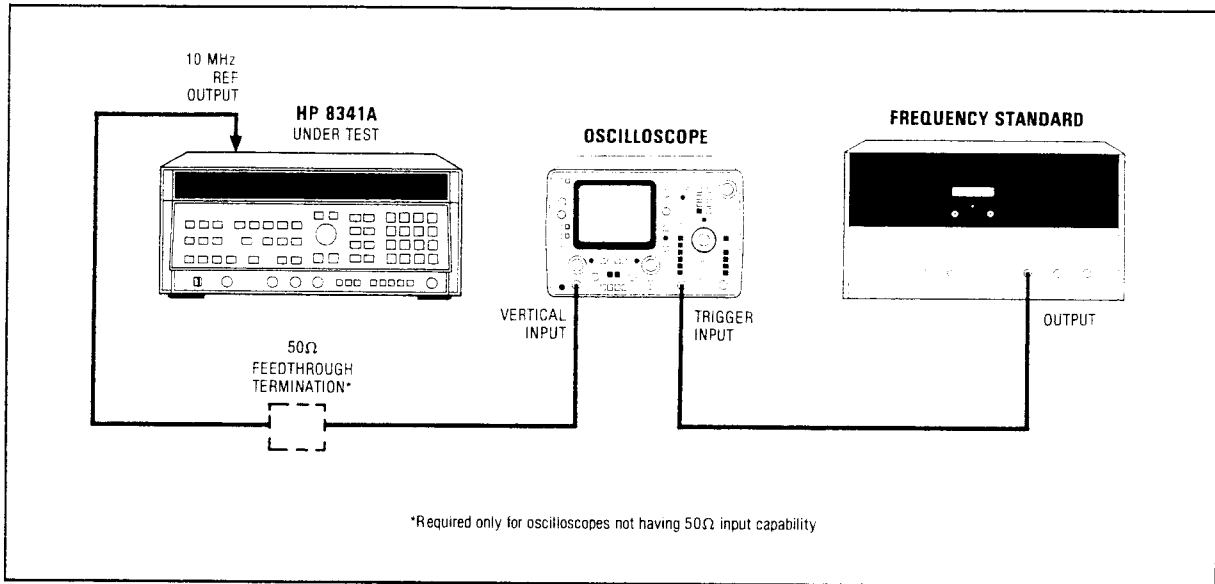

Figure 4-1. Internal Time Base Aging Rate Test Setup

**NOTE**

Be sure the HP 8341A has had 30 days to warmup before beginning this test. If the HP 8341A was disconnected from the ac power line for less than 24 hours, only a 24 hour warmup is required.

**Procedure**

1. Connect the equipment as shown in Figure 4-1.
2. Adjust the oscilloscope external triggering controls for a stable display of the HP 8341A 10 MHz REF OUTPUT signal.
3. Measure the time required for a phase change of 360 degrees. Record the time (T1) in seconds.

T1 = \_\_\_\_\_ seconds (s)

4. Wait for a period of time (from 3 to 24 hours) and remeasure the phase change time (repeat step 3). Record the period of time between measurements (T2) in hours and the new phase change time (T3) in seconds.

T2 = \_\_\_\_\_ hours (h)

T3 = \_\_\_\_\_ seconds (s)

5. Calculate the aging rate from the following equation:

$$\text{Aging Rate} = (1 \text{ cycle}/f)(1/T1 - 1/T3)(T/T2)$$

Where: 1 cycle = the phase change reference for the time measurement. (in this case, 360 degrees)

- f = HP 8341A Time Base output frequency (10 MHz)
- T = specified time for aging rate (24 hours)
- T1 = initial time measurement (s) for 360 degree (1 cycle) change
- T2 = time between measurements (h)
- T3 = final time measurement (s) for a 360 degree (1 cycle) change



**4-9. INTERNAL TIME BASE AGING RATE (Cont'd)**

For example, if:

$$T1 = 351s$$

$$T2 = 3h$$

$$T3 = 349s$$

Then:

$$\begin{aligned} \text{Aging Rate} &= (1 \text{ cycle}/10 \text{ MHz})(1/351s - 1/349s)(24h/3h) \\ &= 1.306 \times 10^{-11} \text{ per day} \end{aligned}$$

6. Verify that the aging rate is less than  $1 \times 10^{-9}$  per day

**NOTE**

**If the absolute frequencies of the frequency standard and the HP 8341A Time Base oscillator are extremely close, the measurement time in steps 3 and 4 (T1 and T3) can be reduced by measuring the time required for a phase change of less than 360 degrees. Change "1 cycle" in the equation accordingly (i.e., 180 degrees = 1/2 cycle, or 90 degrees = 1/4 cycle).**

7. If the aging rate is not within the required tolerance, be sure sufficient warmup time has been allowed and that the environmental conditions have not changed throughout the test, then check the Time Base heater circuit and, if necessary, replace the Time Base. Refer to service and repair information for the A51 10 MHz Reference Oscillator in the Reference Loop – M/N Loop portion of Section VIII. Service.

#### 4-10. FREQUENCY RANGE AND CW MODE ACCURACY

##### Specification

Table 4-3. Frequency Range and CW Mode Accuracy Specifications

Range: 0.01 to 20.00 GHz Resolution: $n \times 1$ Hz Where $n$ = harmonic multiplication number (1 to 3). Refer to Frequency Ranges and Bandswitch Points description in Table 1-1. Accuracy: Same as Time Base Accuracy (refer to Table 1-1).
---

##### Description

The HP 8341A RF output is fed to a frequency counter. The frequency counter internal time base is used as the reference for the HP 8341A to eliminate time base error from the measurement. The HP 8341A frequency display and the counter display should agree, within the resolution of each instrument. This procedure does not test for CW mode accuracy as a function of the time base accuracy.

##### NOTE

A fault in the HP 8341A could cause the two displays to be different. Any fault that would cause one of the phase lock loops to be unlocked would be indicated by a front-panel **FAULT** indication; however, all HP 8341A internal phase lock loops could be locked and the HP 8341A output frequency could be in error (i.e., a phase lock loop frequency divider bit could be stuck). If all the dividers work normally, then CW mode frequency accuracy is essentially guaranteed.

In the following procedure, the test frequencies are selected first to test the maximum frequency range and then to exercise each frequency related circuit throughout its CW range while holding all remaining circuits constant. The test frequencies are grouped so that an abnormal indication would point to the circuit most likely causing the problem.

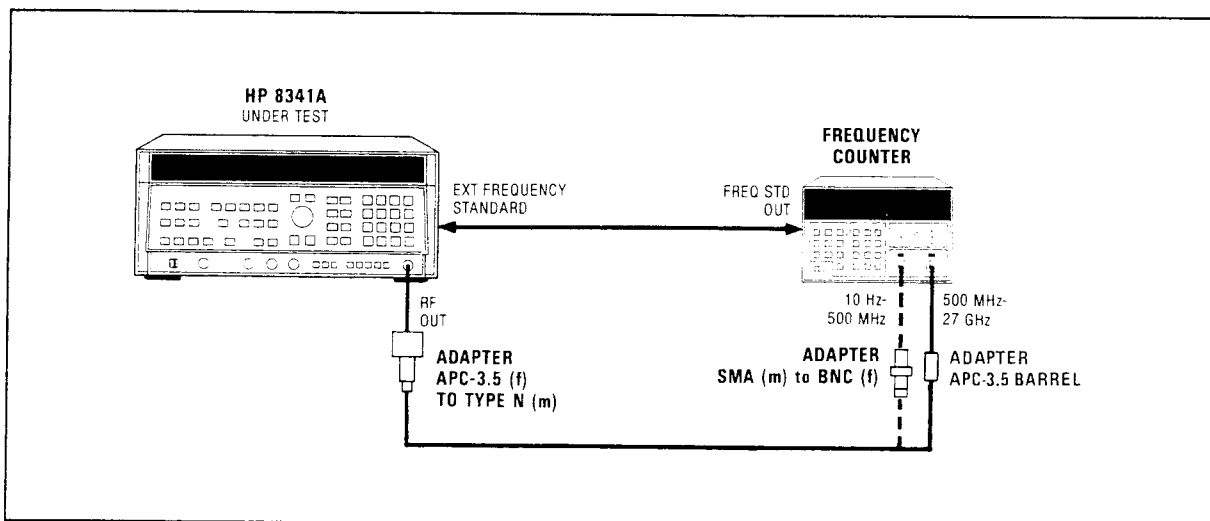

Figure 4-2. Frequency Range Test Setup

#### 4-10. FREQUENCY RANGE AND CW MODE ACCURACY (Cont'd)

##### Equipment

Frequency Counter .....	HP 5343A
Adapter (APC 3.5 Female to Type N (Male)) .....	HP P/N 1250-1744
Adapter SMA (M) to BNC (F) .....	HP P/N 1250-1200
Adapter APC 3.5 Female to Female barrel .....	HP P/N 5061-5311
Cable .....	HP P/N 8340-20124 (Semi-rigid SMA Male to SMA Male)

##### Procedure

1. Connect the equipment as shown in Figure 4-2. Connect the HP 8341A RF Output to the 10 MHz-500 MHz counter input. Allow at least 30 minutes warm up time. The HP 8341A under test and the Frequency Counter use the same frequency standard to eliminate time base error from the measurement. Set the HP 8341A rear panel FREQUENCY STANDARD switch to EXT.
2. Press HP 8341A [INSTR PRESET], then [CW] and enter [1] [0] [MHz]. Press [POWER LEVEL] and enter [-] [2] [0] [dBm]. The counter should indicate 10 MHz  $\pm$  1 Hz  $\pm$  the resolution of the counter.
3. Connect the HP 8341A RF output to the 500 MHz-26.5 GHz counter input. Press the HP 8341A [CW] key and enter [2] [0] [,] [0] [GHz]. The counter should indicate 20.0 GHz  $\pm$  3 Hz  $\pm$  the resolution of the counter.

##### NOTE

Since the same time base is used for both the HP 8341A and the frequency counter, only the displayed frequency is checked. The actual frequency error is  $\pm$  (HP 8341A output frequency / 10 MHz) X time base error  $\pm$  3 Hz.

4. Check the M/N Divider frequencies as follows:

##### NOTE

Pressing [SHIFT] [M1] displays, from left to right, the:  
 M divide number,  
 N divide number,  
 M/N Loop output frequency,  
 20/30 Loop output frequency.

Press [SHIFT] [M5] to exit this diagnostic mode. The instrument continues to operate normally while in the diagnostic display mode.

- a. Press the [CW] key and enter [2] [4] [9] [0] [MHz]. Select a step size of 10 MHz by pressing [SHIFT] [CF] [1] [0] [MHz]. Press [SHIFT] [M1] to display, from left to right, the M divide number, the N divide number, the M/N Loop output frequency, and the 20/30 Loop output frequency. Press the [CW] key to display the CW frequency in the [ENTRY DISPLAY].
- b. Using the down arrow key, step down to 2 300.000000 MHz. Check the counter indication at each step. The counter should indicate the HP 8341A frequency  $\pm$  1 Hz  $\pm$  the resolution of the counter at each step.

**4-10. FREQUENCY RANGE AND CW MODE ACCURACY (Cont'd)****NOTE**

**The above step sets and holds the N Divider to 13 and programs the M Divider through its full range of 8 to 27. Any frequency error as a result of a problem in the M Divider will probably be a multiple of 10 MHz.**

- c. If a significant frequency error is evident, note the conditions under which the error occurred and continue this procedure to determine if any other conditions produce an error.
5. Check the M/N N Divider frequencies as follows:
- a. Select a step size of 200 MHz by pressing **[SHIFT] [CF] [2] [0] [0] [MHz]**. Press **[CW]** to display the CW frequency in the **[ENTRY DISPLAY]**. The CW frequency should be 2 300.000000 MHz.
  - b. Using the up arrow key, step up to 6 900.000000 MHz. Check the counter indication at each step. the counter should indicate the HP 8341A frequency  $\pm 1 \text{ Hz} \pm$  the resolution of the counter.

**NOTE**

**The above step sets and holds the M Divider to 27 and programs the N Divider through its full range of 13 to 36. Any frequency error as a result of a problem in the M Divider will probably be a multiple of 10 MHz.**

- c. If a significant frequency error is evident, note the conditions under which the error occurred and continue this procedure to determine if any other conditions produce an error.
6. Check the 20/30 MHz N2 loop frequencies as follows:
- a. Press **[INSTR PRESET]**. Press **[CF]** key and enter **[2] [3] [1] [0] [.] [5] [MHz]**. Press the **[ΔF]** key and enter **[1] [MHz]**. Select a step size of 1 kHz by pressing **[SHIFT] [CF] [1] [kHz]**.
  - b. Press **[SINGLE]** sweep key to set the HP 8341A to be phase-locked at the start of sweep (2.310 GHz). Press **[SHIFT] [M1]** to enter the diagnostic display mode. Press **[CF]** to display the center frequency in the **[ENTRY DISPLAY]**. The center frequency should be 2.310500 GHz.
  - c. Using the up arrow key, step the center frequency up to 2.310510 GHz. Check the counter indication at each step. The counter should indicate the HP 8341A start frequency (CF – 0.0005 GHz)  $\pm 1 \text{ Hz} \pm$  the resolution of the counter.

## 4-10. FREQUENCY RANGE AND CW MODE ACCURACY (Cont'd)

## NOTE

The above steps set the output of the M/N loop to 180 MHz where  $M=26$  and  $N=13$ . The YO start frequency (2310 MHz) is then 20 to 30 MHz below the Nth harmonic ( $N=13$ ) of 180 MHz ( $180 \times 13 = 2340$ ). The 20/30 MHz output is then 30 MHz. Since the  $\Delta F$  frequency (1 MHz) is between 0.1 to 5 MHz, the 20/30 MHz frequency is derived from the PLL2 75 to 150 MHz VCO output divided by 5 ( $150 \text{ MHz} / 5 = 30 \text{ MHz}$ ). The PLL2 VCO frequency is stepped down in 5 KHz steps which steps the 20/30 frequency from 30 MHz down to 29.990 MHz in 1 kHz steps. Since the M/N frequency remains constant and the HP 8341A output frequency is mixed with a harmonic (13th) of the M/N signal and the resultant output is phase compared to the 20/30 output, the HP 8341A output frequency must increase by 1 kHz/step to satisfy the 20/30 phase lock loop. This checks the least significant (BCD) N2 programming bits.

To observe the N2 PLL2 VCO frequency changes, repeat the N2 loop frequency check (Step 6a through 6c) pressing [SHIFT] [M3] in step 6b rather than [SHIFT] [M1]. [SHIFT] [M3] will display, from left to right, the PLL2 VCO frequency and the PLL3 Up Converter frequency (the PLL3 Up Converter frequency display will be 0 since the PLL3 is not used in the swept mode).

- d. Select a step size of 10 kHz by pressing [SHIFT] [CF] [1] [0] [kHz]. Press [CF] to display the center frequency in the [ENTRY DISPLAY]; the display should indicate 2.310510 GHz.
- e. Using the up arrow key, step the center frequency up to 2.310600 GHz. Check the counter indication at each step. The counter should indicate the HP 8341A start frequency ( $CF - 0.0005 \text{ GHz} \pm 1 \text{ Hz} \pm$  the resolution of the counter).

## NOTE

The above steps program the 20/30 frequency from 29.99 MHz to 29.90 MHz in 0.01 MHz steps and checks additional N2 Divider programming bits.

- f. Select a step size of 100 kHz by pressing [SHIFT] [CF] [1] [0] [0] [kHz]. Press [CF] to display the center frequency in the [ENTRY DISPLAY]. The CF should be at 2.310600 GHz.
- g. Using the up arrow key, step the center frequency up to 2.311500 GHz. Check the counter indication at each step. The counter should indicate the HP 8341A start frequency ( $CF - 0.0005 \text{ GHz} \pm 1 \text{ Hz} \pm$  the resolution of the counter).

## NOTE

The above steps program the 20/30 frequency from 29.9 to 29.0 in 0.1 MHz steps and check additional N2 Divider programming bits.

**4-10. FREQUENCY RANGE AND CW MODE ACCURACY (Cont'd)**

- h. Select a step size of 1 MHz (i.e., press blue **[SHIFT]** key and then **[CF]** key and enter **[1] [MHz]**). Press **[CF]** to display the center frequency in the **[ENTRY DISPLAY]**. The CF should be at 2.311500 GHz.
- i. Using the up arrow key, step the center frequency up to 2.320500 GHz. Check the counter indication at each step. The counter should indicate the HP 8341A start frequency (CF – 0.0005 GHz)  $\pm 1$  Hz  $\pm$  the resolution of the counter.

**NOTE**

**The above steps program the 20/30 frequency from 29.0 MHz to 21.0 MHz in 1 MHz steps. The last CF step programs the 20/30 to 30 MHz and the M/N frequency to 180.769231 MHz. This checks the remaining N2 Divider programming bits.**

- j. If a significant frequency error is evident, note the conditions under which the error occurred and continue this procedure to determine if any other conditions produce an error.
7. Check the 20/30 MHz N1 loop frequencies as follows:
- a. Press **[INSTR PRESET]**. Select a step size of 10 kHz by pressing **[SHIFT] [CF] [1] [0] [kHz]**. Press **[CW]** and enter **[2] [3] [1] [9] [.] [9] [7] [MHz]**.
  - b. Press **[SHIFT] [M1]** to display, from left to right, the M divide number, the N divide number, the M/N Output frequency, and the 20/30 Output frequency.
  - c. Using the down arrow key, step the CW frequency down to 2 319.870000 MHz. Check the counter indication at each step. The counter should indicate the HP 8341A CW frequency  $\pm 1$  Hz  $\pm$  the resolution of the counter.

**NOTE**

**The above steps set the output of the M/N loop to 180 MHz where M=26 and N=13. The PLL1 VCO frequency is stepped up in 100 kHz steps. This steps the 20/30 frequency up from 20.03 MHz in 10 kHz steps to 20.13 MHz. The M/N frequency remains constant and the YO frequency is mixed with a harmonic (13th) of the M/N signal. The resultant output is phase compared to the 20/30 output. The HP 8341A output frequency must decrease by 10 kHz/step to satisfy the YO phase lock loop. This checks the least significant N1 programming bits.**

- d. Select a step size of 100 kHz by pressing **[SHIFT] [CF] [1] [0] [0] [kHz]**. Press the **[CW]** key to view the CW frequency in the **[ENTRY DISPLAY]**. The CW frequency should be at 2319.870000 MHz.
- e. Using the down arrow key, step the CW frequency down to 2 318.970000 MHz. Check the counter indication at each step. The counter should indicate the HP 8341A CW frequency  $\pm 1$  Hz  $\pm$  the resolution of the counter.

**4-10. FREQUENCY RANGE AND CW MODE ACCURACY (Cont'd)****NOTE**

**The above steps program the 20/30 frequency from 20.13 up to 21.03 in 0.1 MHz steps and checks additional N1 Divider programming bits.**

- f. Select a step size of 1 MHz by pressing [**SHIFT**] [**CF**] [**1**] [**MHz**]. Press the [**CW**] key to view the CW frequency in the [**ENTRY DISPLAY**]. The CW frequency should be at 2318.970000 MHz.
- g. Using the down arrow key, step the CW frequency down to 2310.970000 MHz. Check the counter indication at each step. The counter should indicate the HP 8341A CW frequency  $\pm 1 \text{ Hz} \pm$  the resolution of the counter.

**NOTE**

**The above steps program the 20/30 frequency from 21.03 MHz to 29.03 MHz in 1 MHz steps and check the remaining N1 Divider programming bits.**

8. If frequency errors occurred, determine what frequency related circuit is most likely to have caused the symptom (i.e., M/N Loop or 20/30 Loop) then refer to the appropriate troubleshooting Functional Group in Section VIII, Service.

### 4-11. SWEEP TIME ACCURACY

#### Specification

Table 4-4. Sweep Time Accuracy Specifications

Range: 10 milliseconds to 200 seconds forward sweep times Accuracy: $\pm 5\%$ (sweeptimes $\leq 50$ seconds)
---

#### Description

The HP 8341A is swept from 3 GHz to 7 GHz at 6 different sweep times, ranging from 10 ms to 200 sec. The rear panel STOP SWEEP IN/OUT signal of the HP 8341A is used to trigger INPUT A and B on an HP 5316A Universal Counter used in the time interval mode. At the start of a sweep, the STOP SWEEP IN/OUT signal changes from TTL low to TTL high. This pulse triggers INPUT A on the Universal Counter (selected for leading edge triggering) and the count begins. At the end of a sweep, the STOP SWEEP IN/OUT signal changes from TTL high to TTL low. At this point, INPUT B is triggered (selected for trailing edge triggering) and the count is complete. After the Universal Counter has made several counts, an accurate reading of the HP 8341A sweep time is indicated on its display.

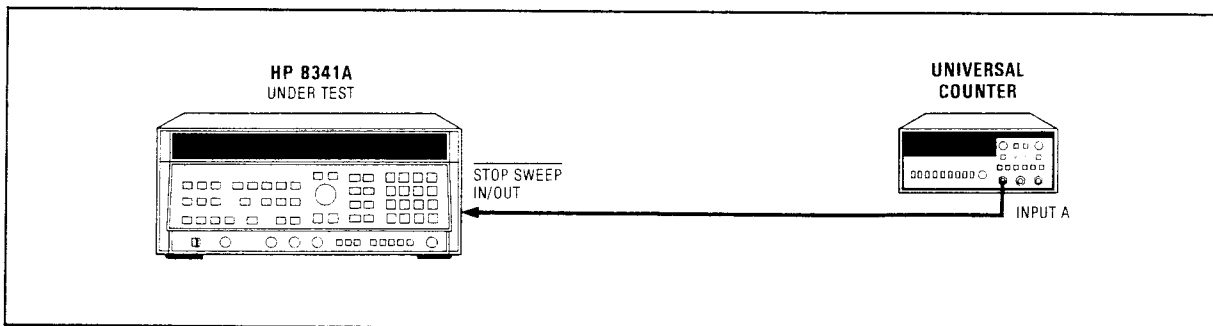

Figure 4-3. Sweep Time Accuracy Test Setup

#### Equipment

Universal Counter ..... HP 5316A

#### Procedure

1. Connect equipment as shown in Figure 4-3. Switch the HP 8341A POWER to ON. Allow the equipment to warm up for 30 minutes.
2. On the HP 8341A, press [INSTR PRESET] [START FREQ] [3] [GHz] [STOP FREQ] [7] [GHz] [POWER LEVEL] [0] [dBm].
3. Set up the HP 5316A as follows:

TI A $\rightarrow$ B .....	IN
GATE TIME .....	MIN
LEVEL/SENSE (CHANNEL A and B) .....	+MAX
TRIGGER (CHANNEL A and B) .....	LEVEL
AC/DC (CHANNEL A and B) .....	DC
ATTN (CHANNEL A and B) .....	X1
FILTER .....	NORM
SEP/COM A .....	COM A
Channel A Triggering .....	Leading Edge
Channel B Triggering .....	Trailing Edge



**4-11. SWEEP TIME ACCURACY (Cont'd)****NOTE**

To ensure that an accurate sweep time indication is obtained from the HP 5316A in step 4, allow the HP 8341A to complete at least three sweeps.

4. On the HP 8341A, press [**SWEEP TIME**] [**1**] [**0**] [**msec**]. Verify that the sweep time displayed by the HP 5316A is within the limits shown in Table 4-5.
5. Repeat step 4 for values shown in Table 4-5.

*Table 4-5. Sweep Time Accuracy Limits*

<b>Selected</b>	<b>Lower Limit</b>	<b>Upper Limit</b>
10 msec	9.5 msec	10.5 msec
100 msec	95 msec	105 msec
1 sec	.95 sec	1.05 sec
10 sec	9.5 sec	10.5 sec
50 sec	47.5 sec	52.5 sec

**4-12. SWEEP FREQUENCY ACCURACY****Specification***Table 4-6. Swept Frequency Accuracy Specifications*

<p>Center Frequency/Sweep Width Mode (CF/<math>\Delta F</math>)</p> <p>Readout Accuracy with respect to sweep out voltage (sweep time &gt; 100 milliseconds):</p> <p><math>\Delta F \leq n \times 5</math> MHz: <math>\pm 1\%</math> of indicated sweep width (<math>\Delta F</math>) <math>\pm</math> time base accuracy*</p> <p><math>\Delta F &gt; n \times 5</math> MHz to <math>&lt; n \times 100</math> MHz: <math>\pm 2\%</math> of indicated sweep width (<math>\Delta F</math>)</p> <p><math>\Delta F \geq n \times 100</math> MHz: <math>\pm 1\%</math> of indicated sweep width (<math>\Delta F</math>), or <math>\pm 50</math> MHz, whichever is less</p> <p>Where <math>n</math> = harmonic multiplication number (1 to 3). Refer to Frequency Ranges and Bandswitch Points description in Table 1-1.</p> <p>* Time Base affects Center Frequency accuracy only, not Sweep Width Accuracy.</p> <p>Start/Stop Mode</p> <p>Readout Accuracy with respect to sweep out voltage (sweep time &gt; 100 milliseconds):</p> <p>Same as Center Frequency/Sweep Width Mode.</p>
--

**Description**

The HP 8341A (DUT) RF output is connected to the HP 8566A Spectrum Analyzer input. The spectrum analyzer is set for zero Hz span at a CW frequency within the HP 8341A swept frequency range. The spectrum analyzer VIDEO OUT (applied to the oscilloscope vertical input) will have a response as the HP 8341A output passes through the frequency that the spectrum analyzer is tuned to. The selected spectrum analyzer bandwidth filter will determine the shape of the response.

The HP 8341A SWEEP OUT, in series with a power supply, is applied to an oscilloscope's horizontal input. The input to the oscilloscope is clamped at  $\pm 0.7$  V by two diodes to prevent overdriving the oscilloscope's input. The oscilloscope is calibrated by setting the HP 8341A and the spectrum analyzer to the same CW frequency (e.g., 20% of Band). To set the HP 8341A to have a SWEEP OUT voltage and at the same time a phase locked CW frequency that is proportional to a percentage of a swept frequency band, the START and STOP frequencies are selected, MANUAL SWEEP is selected, and a frequency equivalent to the desired percentage of band is selected (e.g., START 3 GHz, STOP 5 GHz, MANUAL 3.4 GHz, for 20%). The power supply is adjusted for a DVM indication of zero volts and the oscilloscope horizontal position control is used to position the dot to the center graticule line. With the oscilloscope horizontal sensitivity set to 0.05 V/Division, the CRT horizontal axis is now calibrated to approximately 0.5% of the swept frequency range per division. The spectrum analyzer VIDEO OUT voltage to the oscilloscope is then maximum and the scope vertical position is adjusted to place the dot near the top of the CRT.

The HP 8341A can now be set to sweep any frequency range and the oscilloscope center graticule line will represent the calibrated percentage (e.g., 20%) of the sweep range. The spectrum analyzer center frequency is set to a frequency that is the desired percentage (e.g., 20%) of the HP 8341A swept frequency range. If the HP 8341A swept frequency accuracy is perfect, the oscilloscope trace will be the response of the spectrum analyzer's bandwidth filter, centered on the CRT. If the trace is not centered, the spectrum analyzer center frequency is adjusted to position the response to the center of the oscilloscope CRT. The amount of spectrum analyzer frequency change is the HP 8341A Swept Frequency Accuracy error.

**4-12. SWEPT FREQUENCY ACCURACY (Cont'd)**

Since the circuitry that determines swept frequency accuracy is the same for both  $\Delta F$  Mode and Start/Stop Mode, only Start/Stop Mode swept frequency accuracy is tested.

**NOTE**

The spectrum analyzer resolution bandwidth, and HP 8341A sweep time must be compatible to obtain the desired oscilloscope response. In the test set-up below, 2 APC 3.5 (F) TO TYPE N (M) adapters are used with SMA semi-rigid cable. This set-up must be used instead of simply connecting the DUT to the HP 8566A/B with a Type N cable because Type N cables have much greater power loss.

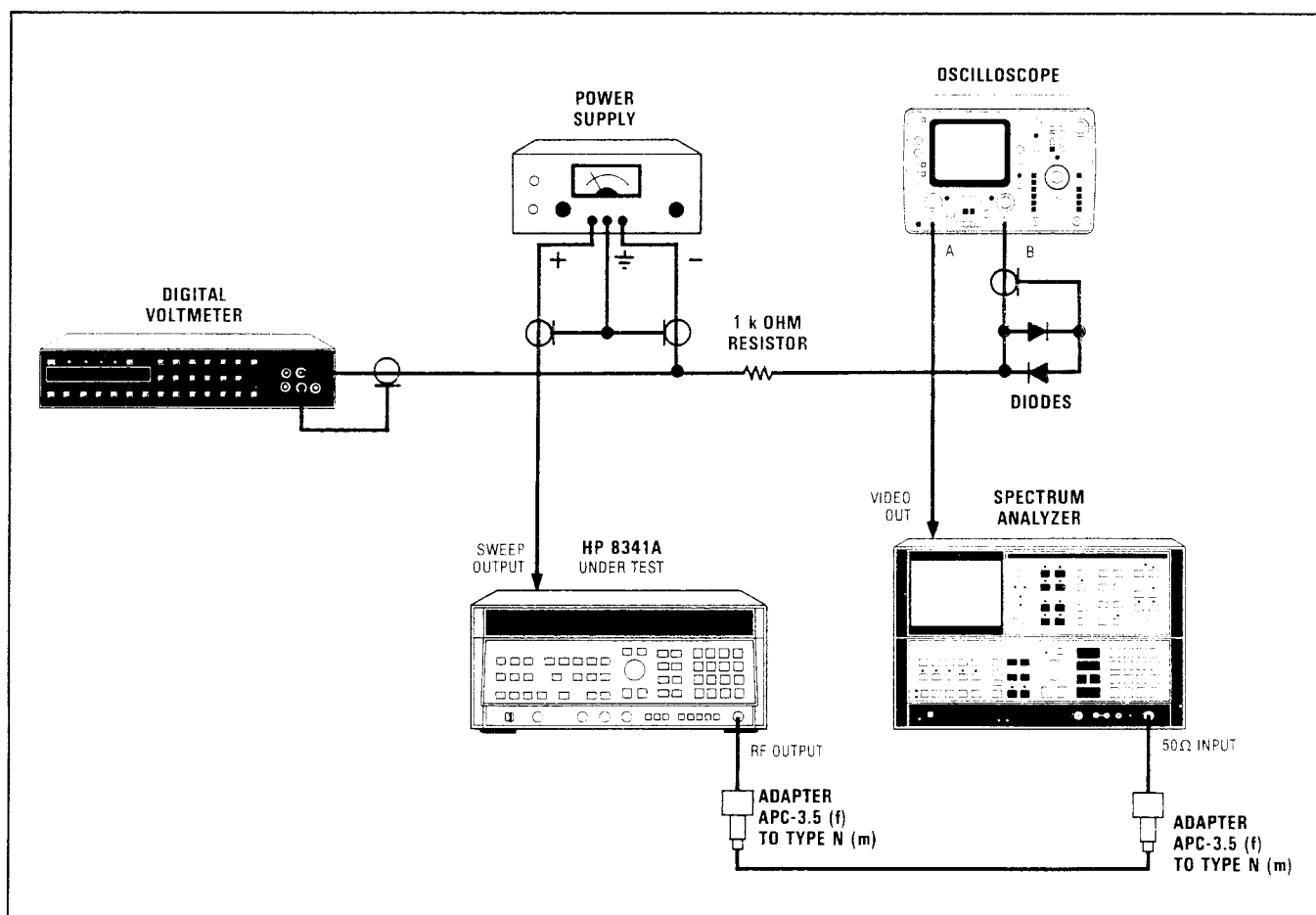

Figure 4-4. Swept Frequency Accuracy Test Setup

**Equipment**

Spectrum Analyzer .....	HP 8566A/B
Oscilloscope .....	HP 1741A
Power Supply .....	HP 6294A
Adapter (2 required) ...	HP P/N 1250-1744 Type N (male) to APC 3.5 (female)
Cable .....	HP P/N 08340-20124 (SMA male to SMA male)
Diode (2 required) .....	HP P/N 1901-0028
Digital Voltmeter .....	HP 3455A
1 KOhm Resistor .....	HP P/N 0757-0280

**4-12. SWEPT FREQUENCY ACCURACY (Cont'd)****Procedure**

1. Connect the equipment as shown in Figure 4-4 (with the power supply output set to 0 Vdc). Allow the equipment to warm up for one hour.
2. Press HP 8341A [**INSTR PRESET**]. Set the oscilloscope to display amplitude versus sweep out voltage (A vs B). Set channel A sensitivity to 0.2V/Div.
3. Set the spectrum analyzer REFERENCE LEVEL to 20 dBm. Set CENTER FREQUENCY to 3.4 GHz for 20% (4 GHz for 50%, or 4.6 GHz for 80%). Set FREQUENCY SPAN to zero. Set RES BW (resolution bandwidth) to 3 MHz.
4. Set HP 8341A to have a sweep out voltage and at the same time, a phase locked CW frequency that is proportional to a percentage of band as follows:
  - a. Press [**START**] and enter [**3**] [GHz]
  - b. Press [**STOP**] and enter [**5**] [GHz].
  - c. Press [**MANUAL**] SWEEP and enter [**3**] [.] [**4**] [GHz] for 20% (4 GHz for 50%, or 4.6 GHz for 80%).

**CAUTION**

**Do not adjust the power supply for greater than  $\pm 10$  Vdc in this procedure.**

5. Adjust the oscilloscope's Channel B sensitivity for 0.05 V/DIV and the horizontal position control for midrange. Adjust the power supply voltage for a DVM indication of  $0 \pm 10$  mVdc.
6. Adjust oscilloscope horizontal position control to position the dot on the center graticule. Adjust the oscilloscope vertical position to place the dot near the top of the CRT.

**NOTE**

**The oscilloscope is now calibrated for 0.5%/Division and for the desired percentage of band (i.e., 20%, 50%, or 80%). Measurements can now be made at this percentage of band for any Start/Stop frequency and any frequency span.**

7. Refer to Table 4-7, press the HP 8341A [**START FREQ**] key and enter the start frequency shown in Table 4-7. Press the [**STOP FREQ**] key and enter the appropriate stop frequency. Press the [**SWEEP TIME**] key and enter the appropriate sweep time. Select the appropriate spectrum analyzer resolution bandwidth. Set the spectrum analyzer center frequency to the appropriate frequency for the percentage of band being tested. Press the HP 8341A [**CONT**] key to return the HP 8341A to the swept mode.
8. Ideally, the oscilloscope response will be at the center graticule line. If not, adjust the spectrum analyzer center frequency to bring the oscilloscope response to the center graticule line. The difference between the original center frequency setting and present center frequency is the HP 8341A swept frequency error. This error should be within the test limit shown in Table 4-7.

4-12. SWEPT FREQUENCY ACCURACY (Cont'd)

Table 4-7. Swept Frequency Accuracy Test Frequencies

HP 8341A			Spectrum Analyzer				Test Limit (kHz)
Start Freq (GHz)	Stop Freq (GHz)	Sweep Time (ms)	Center Frequency (GHz)			Res BW (kHz)	
			20% of Band	50% of Band	80% of Band		
2.3	2.300099	3000	2.3000198	2.3000495	2.3000792	0.3	±0.99
2.3	2.300101	3000	2.3000202	2.3000505	2.3000808	0.3	±1.01
2.3	2.300499	1000	2.3000998	2.3002495	2.3003992	1.0	±4.99
2.3	2.300501	1000	2.3001002	2.3002505	2.3004008	1.0	±5.01
2.3	2.30499	300	2.300998	2.302495	2.303992	3.0	±49.9
2.3	2.30501	300	2.301002	2.302505	2.304008	3.0	±100.02
2.3	2.31	300	2.302	2.305	2.308	3.0	±200
2.3	2.32	100	2.304	2.310	2.316	10	±400
2.3	2.33	100	2.306	2.315	2.324	10	±600
2.3	2.34	100	2.308	2.320	2.332	30	±800
2.3	2.349	100	2.3098	2.3245	2.3392	30	±998
2.3	2.3501	100	2.31002	2.32505	2.34008	30	±1020
2.3	2.36	100	2.312	2.33	2.348	30	±1200
2.3	2.37	100	2.314	2.335	2.356	30	±1400
2.3	2.38	100	2.316	2.34	2.364	30	±1600
2.3	2.39	100	2.318	2.345	2.372	30	±1800
2.3	2.3999	100	2.31998	2.34995	2.37992	30	±1980
2.3	2.4001	100	2.32002	2.35005	2.38008	100	±1001
2.3	2.799	100	2.3998	2.5495	2.6992	1000	±4990
2.3	2.801	100	2.4002	2.5505	2.7008	1000	±5010
2.3	7.29	100	3.298	4.795	6.292	3000	±49900
2.3	7.31	100	3.302	4.805	6.308	3000	±50000
2.3	8.3	100	3.500	5.300	7.100	3000	±50000
2.3	16.452	100	5.1304	9.376	13.6216	3000	±50000
2.3	20.0	100	5.84	11.15	16.46	3000	±50000

9. Repeat steps 3 through 8 to test at 50% and 80% of band.

**NOTE**

**If the swept frequency accuracy error exceeds the test limit, refer to the Sweep Gain and Delay Adjustments in Section V, Adjustments.**



**4-13. MAXIMUM LEVELED OUTPUT POWER AND POWER ACCURACY TEST (Cont'd)**

Table 4-8. Maximum Leveled Output Power and Power Accuracy Specifications (2 of 3)

<b>RF OUTPUT (Cont'd)</b>		
<b>OUTPUT POWER ACCURACY (Cont'd)</b>	<b>Band 0 0.01 to &lt;2.3</b>	<b>Bands 1 - 3 2.3 to 20</b>
<b>OPTION 001</b> (Front Panel Output w/Attenuator)  +18 to +10 dBm <sup>4</sup> +10 to -9.95 dBm -10 to -19.95 dBm -20 to -49.95 dBm -50 to -79.95 dBm -80 to -99.5 dBm -100 to -110 dBm	- ±0.9 dB ±1.2 dB ±1.5 dB ±1.8 dB ±2.1 dB ±2.9 dB <sup>3</sup>	±1.8 dB ±1.5 dB ±2.0 dB ±2.3 dB ±2.6 dB ±2.9 dB ±3.7 dB <sup>3</sup>
<b>OPTION 005</b> (Rear Panel Output w/o Attenuator)  +18 to +10 dBm <sup>4</sup> +10 to -10 dBm -10 to -20 dBm	- ±1.0 dB ±1.8 dB	±1.8 dB ±1.5 dB ±2.3 dB
<b>FLATNESS (Internally leveled)</b>		
<b>STANDARD INSTRUMENT</b>  +18 to +10 dBm <sup>4</sup> +10 to -10 dBm -10 to -20 dBm	- ±0.6 dB ±0.8 dB	±1.0 dB ±0.9 dB ±1.5 dB
<b>OPTION 004</b> (Rear Panel Output w/Attenuator)  +18 to +10 dBm <sup>4</sup> +10 to -11.95 dBm -12 to -21.95 dBm -22 to -51.95 dBm -52 to -81.95 dBm -82 to -99.5 dBm -100 to -110 dBm	- ±0.7 dB ±1.0 dB ±1.3 dB ±1.5 dB ±1.8 dB ±2.0 dB <sup>3</sup>	±1.4 dB ±1.3 dB ±1.8 dB ±2.1 dB ±2.4 dB ±2.7 dB ±3.3 dB <sup>3</sup>
<b>OPTION 001</b> (Front Panel Output w/Attenuator)  +18 to +10 dBm <sup>4</sup> +10 to -9.95 dBm -10 to -19.95 dBm -20 to -49.95 dBm -50 to -79.95 dBm -80 to -99.5 dBm -100 to -110 dBm	- ±0.6 dB ±0.9 dB ±1.2 dB ±1.4 dB ±1.7 dB ±1.9 dB <sup>3</sup>	±1.2 dB ±1.1 dB ±1.6 dB ±1.9 dB ±2.2 dB ±2.5 dB ±3.1 dB <sup>3</sup>
<b>OPTION 005</b> (Rear Panel Output w/o Attenuator)  +18 to +10 dBm <sup>4</sup> +10 to -10 dBm -10 to -20 dBm	- ±0.7 dB ±0.9 dB	±1.2 dB ±1.1 dB ±1.7 dB

### 4-13. MAXIMUM LEVELED OUTPUT POWER AND POWER ACCURACY TEST (Cont'd)

Table 4-8. Maximum Leveled Output Power and Power Accuracy Specifications (3 of 3)

<b>NOTES</b>	
1.	Maximum leveled power from 35°C to 55°C will typically be degraded from these specifications by no more than 2 dB.
2.	Internally leveled, AM off. The POWER dBm display monitors the actual output power, giving accurate readings when unleveled, externally leveled, or when amplitude modulating with a signal that has a dc component. In these modes, the accuracy typically degrades by $\pm 0.1$ dB over the tabulated values. The ENTRY DISPLAY shows the desired power level, or the desired external detector output voltage, exclusive of modulation.
3.	Typical.
4.	The ALC loop typically operates up to +20 dBm to enhance usability at those frequencies where leveled power greater than the maximum specified is available.

#### Description

##### MAXIMUM LEVELED POWER

For maximum leveled power, a crystal detector and an oscilloscope are used to monitor the swept response. The HP 8341A is set to sweep a given frequency band. The power level is increased until the HP 8341A UNLEVELED indicator comes on, then decreased until the UNLEVELED indicator just goes out. The maximum leveled power may differ with sweep mode and sweep time. To find the worst case, the maximum leveled power is checked in three modes: single sweep with auto sweep time, single sweep with a two second sweep time, and continuous sweep. The worst case mode is selected, and a frequency marker is positioned at the minimum power point on the swept display. The HP 8341A is set to CW at the marker frequency and the power is measured using a power meter. The power meter indication should be greater than or equal to the maximum leveled power specification. This procedure is repeated for each frequency band.

##### FLATNESS

Flatness is measured with the RF output level at 0 dBm. Flatness is primarily a function of the RF path; therefore, the response will be essentially the same at all ALC levels. However, in instruments equipped with Option 001 or 004, the response will most likely change when the RF Attenuator is stepped to a different attenuation level. (An automated test is available to adjust the RF attenuator correction factors and verify attenuator flatness; refer to Automated Test Procedures, following this section.)

A power meter is used to measure the RF signal level. An oscilloscope, connected to the power meter recorder output, is used to find the frequencies where the maximum and minimum points of the response occur. The HP 8341A is set to a slow sweep to allow the power meter to respond to any power variations. A marker is positioned at the maximum and minimum points on the oscilloscope display. The HP 8341A is then set to CW at each of the marker frequencies and the power indications are recorded. The maximum power level minus the minimum power level should be within the flatness specification.

##### ACCURACY

The absolute power level at the maximum and minimum points should be within the accuracy specification.

Two different Power Sensors may be required to cover the complete frequency range. The HP 8481A Power Sensor is used from 10 MHz to 50 MHz and the HP 8485A Power Sensor is used for the other frequency bands covering 50 MHz to 20.0 GHz. The HP 8485A Power Sensor can be used down to 10 MHz, but if a minimum or maximum that is close to the test limits occurs in this frequency range, the HP 8481A Power Sensor should be used.



**4-13. MAXIMUM LEVELED OUTPUT POWER AND POWER ACCURACY TEST (Cont'd)**

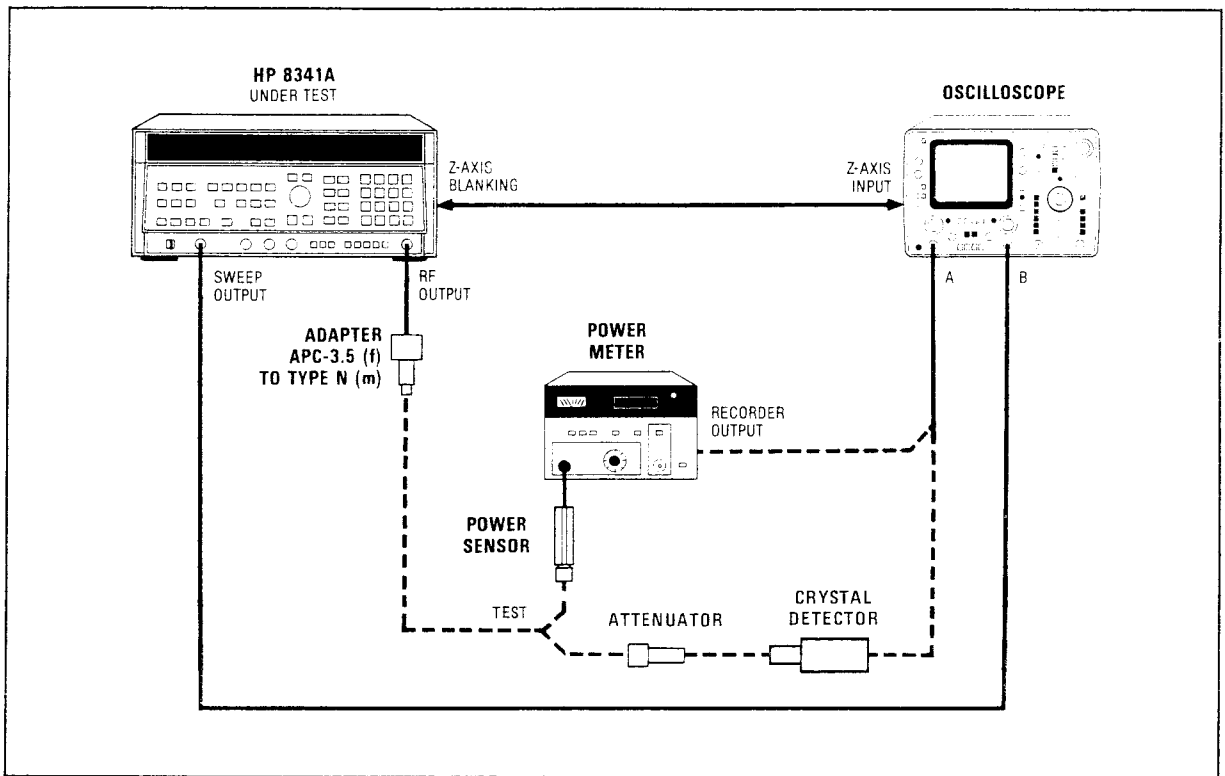

Figure 4-5. Maximum Leveled Output Power and Power Accuracy Test Setup.

**Equipment**

Oscilloscope .....	HP 1741A
Attenuator .....	HP 8493C Opt. 010
Crystal Detector .....	HP 8473A
Power Meter .....	HP 436A
Power Sensor .....	HP 8481A
Power Sensor .....	HP 8485A
Adapter (APC-3.5 female to Type N male) .....	HP P/N 1250-1744

**Procedure**

**MAXIMUM LEVELED POWER**

1. Connect the equipment as shown in Figure 4-5. Connect the 10 dB pad and crystal detector to the HP 8341A RF output and connect the detector output to the oscilloscope channel A input. Allow at least 30 minutes warm up time.
2. Press [INSTR PRESET]. Press [STOP FREQUENCY] and enter [2] [. ] [3] [GHz]. Adjust the oscilloscope to view the swept output of the crystal detector.

In Band 0 (10 MHz to 2.3 GHz), the crystal detector may pass a portion of the RF signal. This RF feedthrough may be visible on the low frequency portion of the oscilloscope trace.

Also, as the power in Band 0 is increased toward maximum leveled, the level of the harmonics may increase and cause a perturbation in the swept response. This will cause the maximum power indication on the oscilloscope to increase without causing the UNLEVELED indicator to light. Therefore, flatness is only specified at  $\leq +10$  dBm in Band 0.

#### 4-13. MAXIMUM LEVELLED OUTPUT POWER AND POWER ACCURACY TEST (Cont'd)

3. Press the **[POWER LEVEL]** key and, using the front panel rotory knob, increase the power level until the UNLEVELED indicator comes on. Slowly decrease the power level until the UNLEVELED indicator just goes off. Note the ENTRY DISPLAY power indication.

#### NOTE

The maximum leveled power indication may differ with sweep mode and sweep time. To find the worst case, the maximum leveled power is checked in continuous sweep with auto sweep time (step 3), single sweep with auto sweep time (step 4), and single sweep with a two second sweep time (step 5).

4. Press **[SINGLE SWEEP]** repeatedly and repeat step 3.
5. Press **[SWEEP TIME]** and enter **[2] [sec]**. Repeat step 3.
6. Select the HP 8341A mode that gave the worst case maximum leveled power indication (lowest ENTRY DISPLAY indication). Press **[M2]** and position the marker, using the rotary knob, to the minimum power level point on the oscilloscope trace (for a negative polarity crystal detector, this is the highest point on the display, for a positive polarity detector, this is the lowest point on the display). Using the oscilloscope vertical position control, position the marker on a horizontal graticule line. Note the marker frequency. Press **[MANUAL]** and enter the frequency noted for M2. Due to SYTM tracking, the RF output level at a single frequency may be greater than in a swept mode; therefore, if the oscilloscope now indicates a higher power level than the swept response (for a positive polarity detector, the trace moves down), press **[POWER LEVEL]** and using the rotary knob adjust the power level to return the dot on the oscilloscope to the horizontal reference line for the minimum swept power point.
7. Disconnect the 10 dB pad and crystal detector and connect the Power Sensor to the HP 8341A RF output. Set the Power Meter's calibration factor switch to include the frequency noted for M2.

To obtain the most accurate Power Meter reading, zero the Power Meter on the range being used. To zero the Power Meter, press the Power Meter RANGE HOLD, press HP 8341A **[RF]** off, zero the Power Meter, and press **[RF]** on.

The Power Meter indication should be equal to or greater than the maximum leveled power specification. If the HP 8341A does not meet its maximum leveled power specification, refer to SRD Bias and SYTM Tracking adjustments in Section V.

8. Press the **[START FREQ]** key and enter the start frequency for the next band. Press the **[STOP FREQUENCY]** key and enter the stop frequency for the next band. Repeat steps 3 through 7 until all frequency bands have been checked.

#### FLATNESS

9. Flatness is measured with the RF output level at 0 dBm. Flatness is primarily a function of the RF path; therefore, the response will be essentially the same at all ALC levels. Although the ALC accuracy is not specified separately, the ALC accuracy is typically <0.15 dB for RF output levels from +10 dBm to -9.95 dBm.

#### 4-13. MAXIMUM LEVELED OUTPUT POWER AND POWER ACCURACY TEST (Cont'd)

To test ALC accuracy:

Place the instrument in CW Mode. Press **[SHIFT] [POWER SWEEP]**. This allows the user control of the ALC power level over its entire power range (−20 to +20 dBm), via the front panel. Press **[0] [dBm]**. Note the actual power level shown on the power meter. Press **[1] [0] [dBm]**. The difference between the actual power level (power meter reading) at 0 dBm and the power meter reading at +10 dBm should be 10 dB ±0.15 dB.

In this fashion test the ALC at 1 dB steps from +10 dBm to −10 dBm. Use the data entry keyboard to change the ALC power level. Do not use the step up or step down keys. In instruments equipped with Option 001 or 004, these keys cause a 10 dB change in the step attenuator setting. Press **[POWER LEVEL]** to exit the direct-ALC-control mode.

Also it should be noted that the power level in the ENTRY DISPLAY is merely the power level requested by the operator. In normal ALC modes, the instrument processor duplicates the ENTRY DISPLAY power level in the POWER dBm display with 0.1 dB resolution; however, if AM is selected, the processor reads the ALC level with an A/D converter, calculates the associated power level, and displays the calculated value in the POWER dBm display.

10. Press **[INSTR PRESET]**. Press **[STOP FREQUENCY]** and enter **[2] [.] [3] [GHz]**. Press **[POWER LEVEL]** and enter **[0] [dBm]**.
11. Press the **[SWEEP TIME]** key and enter **[2] [sec]**.
12. Adjust the oscilloscope controls to view the Power Meter RECORDER OUTPUT voltage versus the HP 8341A SWEEP OUTPUT voltage (A versus B). The oscilloscope vertical gain and position must be changed as a function of the power meter range and RECORDER OUTPUT voltage.
13. Press Frequency Marker key **[M2]** and, using the rotary knob, vary the marker frequency to position the (intensified) marker on the lowest point on the oscilloscope trace. It may be necessary to adjust the oscilloscope INTENSITY to view the marker dot.
14. Note the marker frequency. Press the **[MANUAL]** key and enter the frequency noted for M2. Reset the power meter calibration factor switch to include this frequency. The power meter indication is the minimum power point. Record the power meter indication on the work sheet provided in Table 4-9.

#### NOTE

**For Band 0 (10 MHz to 2.3 GHz), if the minimum or maximum power occurred below 50 MHz, use the HP 8481A Power Sensor to measure the power level.**

15. Press the **[CONT]** key to return to the sweep mode. Press **[M1]** and, using the rotary knob, vary the marker frequency to position the marker on the highest point on the oscilloscope trace. Note the marker frequency. Press the **[MANUAL]** key and enter the frequency noted for M1. Reset the power meter calibration factor switch to include this frequency. The power meter indication is the maximum power point. Record the power meter indication on the work sheet.

**4-13. MAXIMUM LEVELED OUTPUT POWER AND POWER ACCURACY TEST  
(Cont'd)**

*Table 4-9. Maximum Leveled Output Power Test Work Sheet*

<b>Frequency Range: 10 MHz to 2.3 GHz</b>		
	<b>Power Meter Indication</b>	<b>HP 8341A Entry Display</b>
Steps 13, 14	Minimum _____	_____
Step 15	Maximum _____	_____
Step 18	Flatness:	
	Maximum - Minimum _____	( $\leq 1.2$ dB, Standard) ( $\leq 1.4$ dB, Option 004) ( $\leq 1.2$ dB, Option 001) ( $\leq 1.4$ dB, Option 005)
<b>Frequency Range: 2.3 GHz to 7.0 GHz</b>		
	<b>Power Meter Indication</b>	<b>HP 8341A Entry Display</b>
Steps 13, 14	Minimum _____	_____
Step 15	Maximum _____	_____
Step 18	Flatness:	
	Maximum - Minimum _____	( $\leq 1.8$ dB, Standard) ( $\leq 2.6$ dB, Option 004) ( $\leq 2.2$ dB, Option 001) ( $\leq 2.2$ dB, Option 005)
<b>Frequency Range: 7.0 GHz to 13.5 GHz</b>		
	<b>Power Meter Indication</b>	<b>HP 8341A Entry Display</b>
Steps 13, 14	Minimum _____	_____
Step 15	Maximum _____	_____
Step 18	Flatness:	
	Maximum - Minimum _____	( $\leq 1.8$ dB, Standard) ( $\leq 2.6$ dB, Option 004) ( $\leq 2.2$ dB, Option 001) ( $\leq 2.2$ dB, Option 005)
<b>Frequency Range: 13.5 GHz to 20.0 GHz</b>		
	<b>Power Meter Indication</b>	<b>HP 8341A Entry Display</b>
Steps 13, 14	Minimum _____	_____
Step 15	Maximum _____	_____
Step 18	Flatness:	
	Maximum - Minimum _____	( $\leq 1.8$ dB, Standard) ( $\leq 2.6$ dB, Option 004) ( $\leq 2.2$ dB, Option 001) ( $\leq 2.2$ dB, Option 005)

**4-13. MAXIMUM LEVELED OUTPUT POWER AND POWER ACCURACY TEST  
(Cont'd)**

16. Press the **[CONT]** key to return to the swept mode. Press the **[START FREQ]** key and enter the start frequency for the next frequency band. Press the **[STOP FREQ]** key and enter the stop frequency for the next frequency band.
17. Repeat steps 12 through 16 to measure the flatness until all frequency bands have been checked.
18. The maximum minus the minimum power meter indications should be within the flatness specifications. If the HP 8341A does not meet its flatness specification, refer to Flatness Adjustments in Section V.

**ACCURACY**

19. The absolute power level at the maximum and minimum points should be within the accuracy specification. This test may be repeated at other ALC power levels (+10 dBm to -10 dBm) to verify flatness and accuracy specifications over the ALC range.

#### 4-14. EXTERNAL LEVELING

##### Specification

Table 4-10. External Leveling Specifications

XTAL: Allows the HP 8341A to be externally leveled by crystal detectors of positive or negative polarity.

METER: Allows power meter leveling with any HP power meter.

Range (XTAL or METER): 500 microvolts ( $-66$  dBV) to 2.0 volts ( $+6$  dBV)

Accuracy of voltage at EXT INPUT connector relative to the displayed level (leveling voltage is shown in ENTRY DISPLAY in dBV):  $\pm 0.5$  dB  $\pm 200$  microvolts

##### Description

The HP 8341A external leveling circuit is designed to maintain a constant voltage at the EXT INPUT BNC. This is achieved by first selecting a voltage (in dBV) to which the EXT INPUT will be leveled. This establishes a reference voltage for the ALC. The voltage at the EXT INPUT is then routed through the external leveling circuitry to the ALC and compared to the reference. If a difference between the two voltages exist, the HP 8341A RF OUTPUT power will be adjusted to compensate for the difference.

The HP 8341A's external leveling circuit allows a positive or negative crystal detector to be used in the external leveling loop. A positive crystal detector (HP 8473A) is used in this test but a negative crystal detector may be substituted.

The HP 8341A XTAL Leveling mode is selected to verify the HP 8341A's external leveling specification. Nine different dBV values, ranging from  $+6$  dBV to  $-66$  dBV, are selected and the voltage accuracy at the EXT INPUT is checked with a DVM.

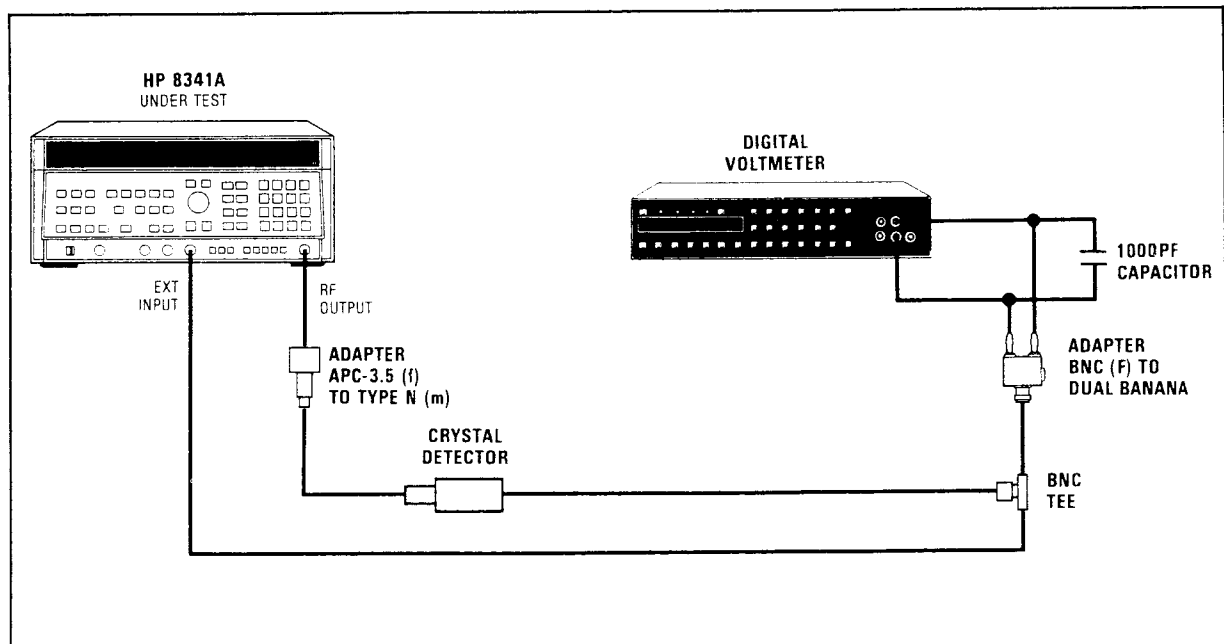

Figure 4-6. External Leveling Test Setup

**4-14. EXTERNAL LEVELING (Cont'd)**

**Equipment**

Digital Voltmeter (DVM).....	HP 3455A
Crystal Detector.....	HP 8473A
Capacitor (1000 pF).....	HP P/N 0160-4574
Adapters	
APC 3.5 (f) to Type N (m).....	HP P/N 1250-1744
BNC(f) to Dual Banana.....	HP P/N 1251-2277
BNC Tee (m) (f) (f).....	HP P/N 1250-0781
Attenuators (not required for Option 001 or Option 004 HP 8341A)	
10 dB.....	HP 8493C Opt. 010
20 dB.....	HP 8493C Opt. 020

**Procedure**

1. Turn HP 8341A LINE switch ON. Press [INSTR PRESET] [CW] [4] [.] [5] [GHz] [POWER LEVEL] [0] [dB(m)].
2. Connect equipment as shown in Figure 4-6 (note 1000 pF capacitor shunting DVM input). Allow the equipment to warm up for 30 minutes.

**NOTE**

In step 3, XTAL mode is selected. In this mode, the [dB(m)] terminator key selects dBV. The dBV value selected corresponds to a voltage at which the HP 8341A EXT INPUT will be leveled (see Table 4-14). The selected dBV is displayed in the ENTRY DISPLAY.

**NOTE**

If a negative-polarity crystal detector is being used for this test, the voltages given in Tables 4-11, 4-12, 4-13, and 4-14 will all be negative.

3. Press [XTAL] [6] [dB(m)]. DVM reading should be within the values shown on the first line in Table 4-11.

*Table 4-11. External Leveling Limits (With No Attenuator)*

dBv Selected	DVM Indication (V)		
	Lower Limit	Ideal	Upper Limit
+6	1.883	1.995	2.114
0	0.944	1.000	1.059
-10	0.2983	0.3162	0.3352
-20	0.0942	0.1000	0.1061

4. Repeat Step 3 for the remaining dBV values shown in Table 4-11.
5. Install the 10 dB attenuator between the RF output and detector. (HP 8341As with Option 001 or 004 include an internal attenuator and do not require the external attenuator. For these instruments, press the down step key to select 10 dB of attenuation.)

**4-14. EXTERNAL LEVELING (Cont'd)**

6. Repeat Step 3 for values shown in Table 4-12.

*Table 4-12. External Leveling Limits (With 10 dB Attenuator)*

<b>dBv Selected</b>	<b>DVM Indication (mV)</b>		
	<b>Lower Limit</b>	<b>Ideal</b>	<b>Upper Limit</b>
-30	29.65	31.62	33.70
-40	9.24	10.00	10.79

7. Install the 20 dB attenuator between the RF output and detector. (HP 8341As with Option 001 or 004 include an internal attenuator and do not require the external attenuator. For these instruments, press the down step key to select 20 dB of attenuation.)

8. Repeat Step 3 for values shown in Table 4-13.

*Table 4-13. External Leveling Limits (With 20 dB Attenuator)*

<b>dBv Selected</b>	<b>DVM Indication (mV)</b>		
	<b>Lower Limit</b>	<b>Ideal</b>	<b>Upper Limit</b>
-50	2.785	3.162	3.550
-60	0.744	1.000	1.259
-66	0.273	0.501	0.731



**4-14. EXTERNAL LEVELING (Cont'd)***Table 4-14. dBV vs Voltage Reference Table*

<b>dBV</b>	<b>Voltage</b>	<b>dBV</b>	<b>Voltage</b>
7	2.239 V	-12	0.2512 V
6	1.995 V	-19	0.1122 V
5	1.778 V	-20	0.1000 V
4	1.585 V	-21	89.13 mV
3	1.413 V	-29	35.48 mV
2	1.259 V	-30	31.62 mV
1	1.122 V	-31	28.18 mV
0	1.000 V	-39	11.22 mV
-1	0.8913 V	-40	10.00 mV
-2	0.7943 V	-41	8.913 mV
-3	0.7079 V	-49	3.548 mV
-4	0.6310 V	-50	3.162 mV
-5	0.5623 V	-51	2.818 mV
-6	0.5012 V	-59	1.122 mV
-7	0.4467 V	-60	1.000 mV
-8	0.3981 V	-61	0.8913 mV
-9	0.3548 V	-65	0.5623 mV
-10	0.3162 V	-66	0.5012 mV
-11	0.2818 V	-67	0.4467 mV

**4-15. SPURIOUS SIGNALS TEST (10 MHz to 20 GHz)****Specification***Table 4-15. Spurious Signals Test (10 MHz to 20 GHz) Specifications*

<b>SPURIOUS SIGNALS</b> (Expressed in dB relative to the carrier level (dBc) at ALC level of 0 dBm)	<b>Bands and Approximate Frequency Ranges (GHz)</b> (See Frequency Ranges and Bandswitch Points for complete description.)			
	<b>Band 0</b> <b>0.01 to &lt;2.3</b>	<b>Band 1</b> <b>2.3 to &lt;7.0</b>	<b>Band 2</b> <b>7.0 to &lt;13.5</b>	<b>Band 3</b> <b>13.5 to 20.0</b>
<b>Harmonics</b> (up to 20.0 GHz)	< -35	< -35	< -35	< -35
<b>Subharmonics and multiples thereof</b> (up to 20.0 GHz)	—	—	< -25	< -25
<b>Non-harmonically related spurious</b> (CW and Manual Sweep mode only)	< -50	< -70	< -60	< -60
<b>Power line related and spurious due to fan rotation within 5 Hz below line frequency, and multiples thereof</b>				
(CW mode only, all power levels)	<b>Band 0</b> <b>0.001 to &lt;2.3</b>	<b>Band 1</b> <b>2.3 to &lt;7.0</b>	<b>Band 2</b> <b>7.0 to &lt;13.5</b>	<b>Band 3</b> <b>13.5 to 20.0</b>
Offset <300 Hz from carrier	< -50	< -50	< -44	< -40
Offset 300 Hz to 1 kHz from carrier	< -60	< -60	< -54	< -50
Offset > 1 kHz from carrier	< -65	< -65	< -59	< -55

**Description**

The HP 8341A RF output signal is displayed on a spectrum analyzer to verify that the harmonic and non-harmonic spurious signals are at or below the specified level.

4-15. SPURIOUS SIGNALS TEST (10 MHz to 20 GHz) (Cont'd)

NOTE

In the test setup below, 2 APC 3.5 (f) to Type N (m) adapters are used with SMA semi-rigid cable. This setup is used instead of simply connecting the DUT to the HP 8566A/B with a Type N cable because Type N cables have much greater power loss.

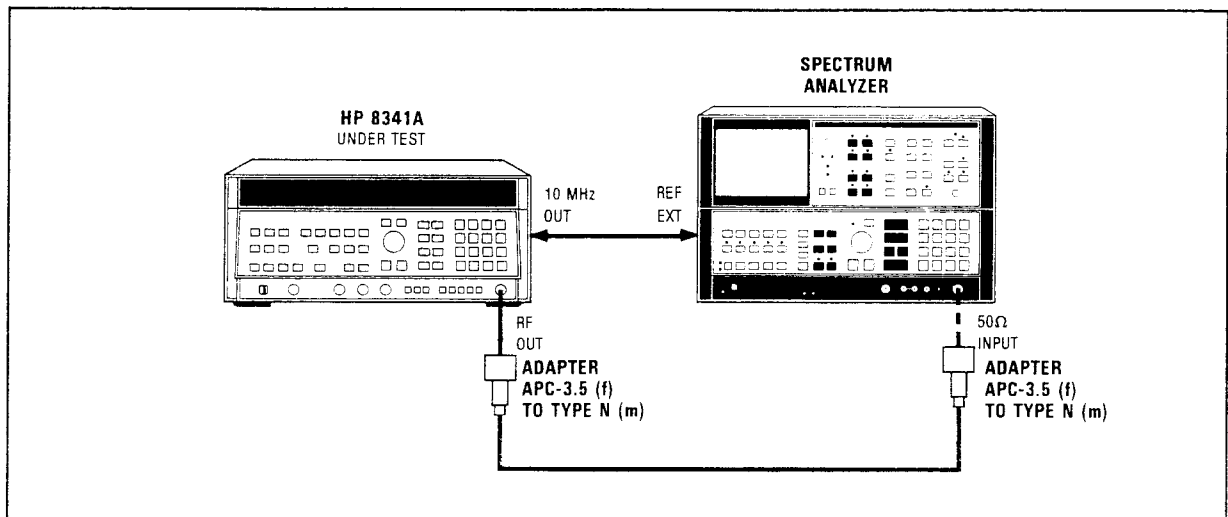

Figure 4-7. Spurious Signals Test Setup (10 MHz to 20 GHz)

Equipment

Spectrum Analyzer .....	HP 8566A/B
Adapter .....	HP P/N 1250-1744
(APC-3.5 female to Type N male (2 required))	
Cable .....	HP P/N 08340-20124
(SMA male to SMA male)	

Procedure

1. Connect equipment as shown in Figure 4-7. The position of the HP 8341A under test can affect spurious responses: therefore, place the HP 8341A in its normal operating position (i.e., flat on its feet) for this test. Allow at least 30 minute warm up time.
2. Press the HP 8341A [INSTR PRESET]. Press the [STOP FREQ] key and enter [2] [.] [3] [GHz].
3. Press the HP 8341A [POWER LEVEL] key and enter [0] [dBm].
4. Press the [CW] key and enter any frequency of interest within the selected frequency range.
5. Set up the spectrum analyzer to view the HP 8341A RF output signal. Set the reference level to place the peak of the HP 8341A RF output signal on the reference level at the top graticule line.

**4-15. SPURIOUS SIGNALS TEST (10 MHz to 20 GHz) (Cont'd)****NOTE**

When using a spectrum analyzer other than the HP 8566A/B, the spectrum analyzer may originate some mixing products that could appear on the display. If a signal is in question, increase the spectrum analyzer input attenuation by 10 dB, note if signal decreases in amplitude by 10 dB, then return the attenuator to its original position. If the signal in question comes from an external source, it will change by exactly 10 dB. If the signal in question originates in the spectrum analyzer, the level will either change by greater or less than 10 dB or may not change at all.

The HP 8341A rotary knob circuit may generate some noise spikes when the knob is rotated. These signals should disappear when rotation is stopped.

If a spurious signal is found and it appears out of specification, check the fundamental signal amplitude to ensure it is at 0 dBm. Then check spurious level by substituting a known amplitude signal on the spectrum analyzer.

6. Tune the spectrum analyzer across its full frequency range. Look for any spurious signals. For each spurious response determine what mechanism generated the spurious response and what specification applies.
  - a. Is the spurious response in question an integer multiple of the HP 8341A RF output signal? If it is, the "harmonic" specification applies.
  - b. Press the HP 8341A [**SHIFT**] key and then [**M2**] to display, from left to right, the YO harmonic number and the YO frequency. Is the spurious response in question an integer multiple of the YO frequency (and not a harmonic of the RF signal)? If it is the "subharmonic and multiples thereof" specification applies.

**NOTE**

**Press the [**CW**] key to view the CW frequency in the ENTRY DISPLAY.**

- c. If the spurious response in question does not meet one of the above criteria, the "non-harmonically related" specification applies.
7. Repeat steps 4 through 7 at any frequency of interest within this frequency band.
8. Press the HP 8341A [**STOP FREQ**] key and enter the stop frequency for the next frequency band. Press the [**START FREQ**] key and enter the start frequency for the next frequency band. Repeat steps 3 through 8 until all HP 8341A frequency bands have been tested up to 20 GHz.

4-16 INTENTIONALLY LEFT BLANK

(Table 4-16 and Figure 4-8 have been omitted)

4-16 INTENTIONALLY LEFT BLANK

(Table 4-16 and Figure 4-8 have been omitted)

4-16 INTENTIONALLY LEFT BLANK

(Table 4-16 and Figure 4-8 have been omitted)

## 4-17. SINGLE SIDEBAND PHASE NOISE

### Specification

Table 4-17. Single-sideband Phase Noise Specifications

SPURIOUS SIGNALS [Expressed in dB relative to the carrier level (dBc)]	Bands and Approximate Frequency Ranges (GHz) (See Frequency Ranges and Bandswitch Points for complete description)			
	Band 0 0.01 to <2.3	Band 1 2.3 to <7.0	Band 2 7.0 to <13.5	Band 3 13.5 to 20.0
<b>Single-sideband Phase Noise</b> (dBc/1 Hz BW, CW Mode, all power levels)				
Offset 100 Hz from carrier	< -67	< -67	< -61	< -57
Offset 1 kHz from carrier	< -75	< -75	< -69	< -65
Offset 10 kHz from carrier	< -83	< -83	< -77	< -73
Offset 100 kHz from carrier	< -107	< -107	< -101	< -97

### Description

This test is performed in three steps: SYSTEM CALIBRATION, PHASE NOISE MEASUREMENT, and PHASE NOISE CALCULATION. A second HP 8341A is used as a local oscillator (LO) to mix down the microwave frequency from the HP 8341A under test (DUT) to a 1 MHz IF. The IF signal is amplified and, for 30 Hz, 100 Hz and 1 kHz offsets, sent directly to a low frequency spectrum analyzer (HP 3585A). For 10 kHz and 100 kHz offsets, a 1 MHz notch filter is inserted between the amplifier and the HP 3585A to attenuate IF signal and obtain increased dynamic range on the HP 3585A. Phase noise is measured using the OFFSET and NOISE LVL functions of the HP 3585A.

SYSTEM CALIBRATION obtains the system's frequency response data (Cal Data (CD) and IF Cal Data (IFCD), measured in dBc). A zero dBm, 1 MHz IF is established and then the LO FREQUENCY IS REDUCED TO OBTAIN 1.00003, 1.0001, and 1.001 MHz IFs. At each point, the power level at the peak of the IF is recorded as the Cal Data (CD). A 1 MHz notch filter is then inserted between the amplifier and the HP 3585A. The LO frequency is again reduced to obtain 1.01 and 1.1 MHz IFs, and the Cal Data for these points is recorded. The LO frequency is then increased to obtain a 1 MHz IF and the response due to the 1 MHz notch filter is recorded as the IF Cal Data (IFCD). This data is required for calculating the actual phase noise for the 10 kHz and 100 kHz offsets. Since it is not required for the 30 Hz, 100 Hz and 1 kHz offsets, IFCD is defined as zero at these points.

PHASE NOISE MEASUREMENT obtains phase noise data for DUT frequencies of 2.202, 6.902, 13.402 and 19.502 GHz. These specific frequencies typically have the worst case phase noise for the HP 8341A. The DUT is adjusted for the test frequency and then the LO frequency is adjusted to obtain a 1 MHz  $\pm 0.9$  Hz IF. A signal to noise level (IF to phase noise level at 30 Hz, 100 Hz, 1 kHz, 10 kHz, and 100 kHz offsets from IF) measurement is performed using the OFFSET and NOISE LVL functions of the HP 3585A and the results are recorded as the Measured Noise Level (MNL, measured in dBc).



**4-17. SINGLE SIDEBAND PHASE NOISE (Cont'd)**

PHASE NOISE CALCULATION takes the data obtained for MNL and adds and subtracts the calibration data and a 3 dB correction factor to obtain the actual phase noise. The formula that is used is:

$$\text{Actual Phase Noise} = \text{MNL} + \text{IFCD} - \text{CD} - 3 \text{ dB}$$

IFCD is the response of the 1 MHz notch filter at 1 MHz. Since the filter is not installed during the 10 Hz, 100 Hz and 1 kHz offset measurements, IFCD = 0. During the 10 kHz and 100 kHz offset measurements, the notch filter attenuates the IF causing the power difference between the IF and the phase noise to be smaller than it actually is, therefore IFCD must be added to MNL to correct for this. The system's frequency response (CD) causes the difference between the IF level and the phase noise level to be greater than it actually is, therefore CD must be subtracted from MNL. A factor of 3 dB is subtracted from MNL to correct for the LO's phase noise contribution.

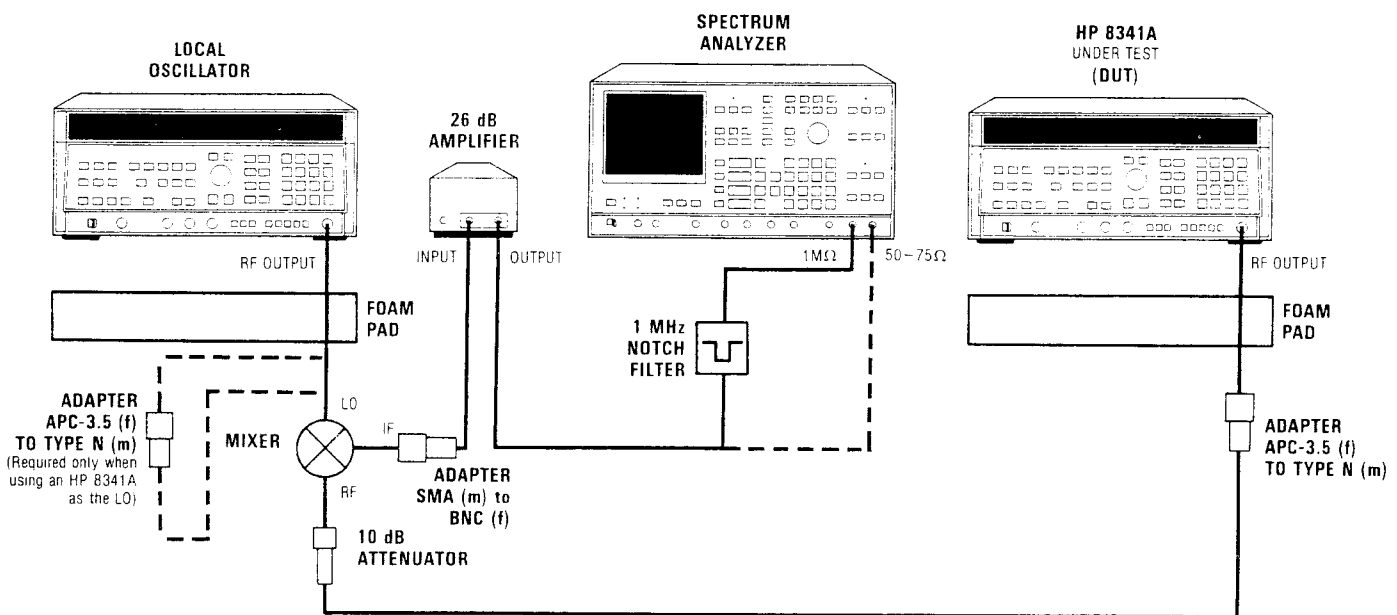

Figure 4-9. Single Sideband Phase Noise Test Setup

**Equipment**

Local Oscillator.....	HP 8341A Opt. 001 or HP 8341A (Std)
Spectrum Analyzer .....	HP 3585A
Power Amplifier.....	HP 8447F
Attenuator.....	HP 8493C Opt. 010
Mixer.....	RHG DMS 1-26
Adapters	
APC 3.5 (f) to Type N (m).....	HP P/N 1250-1744
APC 3.5 (m) to Type N (m) .....	HP P/N 1250-1743
SMA (m) to BNC (f).....	HP P/N 1250-1200
Foam Pads.....	(Refer to note following step 1)
1 MHz Notch Filter .....	(See schematic in Recommended Test Equipment list, Section I)

**4-17. SINGLE SIDEBAND PHASE NOISE (Cont'd)****Procedure**

1. Connect equipment as shown in Figure 4-9 with the amplifier connected directly to the HP 3585A 50 Ohm input.

**NOTE**

**The foam pads shown in Figure 4-9 are required to isolate the DUT and LO from mechanical vibrations which could induce phase noise.**

**NOTE**

**In this procedure, the LO is programmed for +10 dBm. At some points the LO may indicate an unlevelled condition. This is to be expected and does not affect the phase noise measurement.**

2. On the LO, press [INSTR PRESET] [CW] [2] [.] [2] [0] [1] [GHz] [POWER LEVEL] [1] [0] [dB(m)] [PEAK].
3. On the DUT, press [INSTR PRESET] [CW] [2] [.] [2] [0] [2] [GHz] [POWER LEVEL] [0] [dB(m)] [PEAK].
4. On the HP 3585A, press INSTR PRESET, CENTER FREQUENCY, 1 MHz, FREQUENCY SPAN, 1 MHz.
5. Switch the HP 3585A AUTO RANGE and REF LVL TRACK off.
6. Allow the equipment to warm up for 1 hour.
7. Adjust the HP 3585A marker to the peak of the IF.
8. On the HP 3585A, press COUNTER.
9. Adjust the frequency of the LO for a HP 3585A COUNTER reading of 1 MHz  $\pm$ 0.9 Hz. This removes any frequency offsets between the DUT and LO.
10. Adjust the output power of the DUT for 0 dBm at the peak of the IF. Select a REFERENCE LEVEL of 0 dBm on the HP 3585A.

**SYSTEM CALIBRATION**

- 30 Hz Offset Calibration (Perform the 30 Hz Offset Calibration Test only when testing an instrument equipped with Option 007. Improved Phase Noise Specifications)
11. On the HP 3585A, press FREQUENCY SPAN, 250 Hz, RES BW, 3 Hz. Allow one sweep to occur. Ensure power at peak of IF is still 0 dBm.
  12. Reduce LO frequency by 30 Hz (IF = 1.00003 MHz  $\pm$ 0.9 Hz).
  13. Allow one sweep of the HP 3585A to occur. Adjust the HP 3585A marker to the peak of the IF. Record the marker power level (Cal Data) into Table 4-18.

**4-17. SINGLE SIDEBAND PHASE NOISE (Cont'd)**

*Table 4-18. Phase Noise Calibration Data*

Step	Offset (Hz)	Cal Data (dB)
13	30 (Option 007 only)	CD =
14	100	CD =
16	1K	CD =
19	10K	CD =
21	100K	CD =
22	0	IFDC =

● 100 Hz Offset Calibration

14. Reduce the LO frequency by 70 Hz (IF = 1.0001 MHz ±0.9 Hz). Repeat step 13.

● 1 kHz Offset Calibration

15. On the HP 3585A, press FREQUENCY SPAN, 2500 Hz, RES BW, 30 Hz.

16. Reduce LO frequency by 900 Hz (IF = 1.001 MHz ±0.9 Hz). Repeat step 13.

● 10 kHz Offset Calibration

17. Connect 1 MHz Notch Filter as shown in Figure 4-9. Select 1 MOhm input impedance on the HP 3585A.

18. On the HP 3585A, press FREQUENCY SPAN, 25 kHz, RES BW, 100 Hz.

19. Reduce LO frequency by 9 kHz (IF = 1.01 MHz ±0.9 Hz). Repeat step 13.

● 100 kHz Offset Calibration

20. On the HP 3585A, press FREQUENCY SPAN, 250 kHz, RES BW, 1 kHz.

21. Reduce LO frequency by 90 kHz (IF = 1.1 MHz ±0.9 Hz). Repeat step 13.

● IF Cal Data

22. Increase the LO frequency by 100 kHz (IF = 1 MHz ±0.9 Hz). Repeat step 13.

**PHASE NOISE MEASUREMENT**

23. Connect equipment as shown in Figure 4-9 with the amplifier connected directly to the HP 3585A 50 Ohm input. Return HP 3585A to 50 Ohm input impedance.

24. On the DUT, press [**POWER LEVEL**] [**0**] [**dB(m)**]. Select a HP 3585A REFERENCE LEVEL to place the peak of the IF at the top graticule of the display. Ensure IF = 1 MHz ±0.9 Hz. If necessary, adjust LO for a HP 3585A COUNTER reading of 1 MHz ±0.9 Hz.

25. On the HP 3585A, press FREQUENCY SPAN, 250 Hz, RES BW, 3 Hz. Step the RANGE until the overload light just turns on and then increment it one step. Allow one sweep to occur.

**4-17. SINGLE SIDEBAND PHASE NOISE (Cont'd)**

- 30 Hz Offset (Perform the 30 Hz Offset Test only when testing an HP 8341A equipped with Option 007. Improved Phase Noise Specifications.)
26. On the HP 3585A, press **MANUAL, CLEAR A, MKR→CF, COUNTER**.
27. On the HP 3585A, press **OFFSET, ENTER OFFSET, CF STEP SIZE, 30 Hz, MANUAL, STEP UP** (key), **NOISE LVL**. The noise level measurement takes approximately 30 seconds. For an accurate reading, allow at least 2 measurements to be made before recording value. Record Measured Noise Level (MNL) into Table 4-19.

*Table 4-19. Phase Noise Measurement Data*

Step	Offset (Hz)	Measured Noise Level (MNL, dBc (1 Hz))			
		2.202 GHz	6.902 GHz	13.402 GHz	19.502 GHz
27	30 (Option 007 only)				
29	100				
31	1K				
34	10K				
36	100K				

28. On the HP 3585A, press **COUNTER, NOISE LVL, OFFSET, CONT**. Return marker to peak of IF and ensure **COUNTER** reading is 1 MHz  $\pm$ 0.9 Hz. If necessary, adjust LO for a 1 MHz IF. If the IF drifted more than 6 Hz, steps 26 through 28 must be repeated.
- 100 Hz Offset
29. Repeat steps 26 through 28 with a **CF STEP SIZE** of 100 Hz substituted in step 27.
- 1 kHz Offset
30. On the HP 3585A, press **FREQUENCY SPAN, 2.5 kHz, RES BW, 30 Hz**.
31. Repeat steps 26 through 28 with a **CF STEP SIZE** of 1 kHz substituted in step 27.
- 10 kHz Offset
32. Connect the equipment as shown in Figure 4-9 with the 1 MHz Notch Filter connected. Select the 1 MOhm input impedance on the HP 3585A.
33. On the HP 3585A, press **FREQUENCY SPAN, 25 kHz; RES BW, 100 Hz**. Decrement the **RANGE** until the overload light just turns on and then increment it one step.
34. Repeat steps 26 through 28 with a **CF STEP SIZE** of 10 kHz substituted in step 27.

**4-17. SINGLE SIDEBAND PHASE NOISE (Cont'd)**

- 100 kHz Offset

35. On the HP 3585A, press FREQUENCY SPAN, 250 kHz, RES BW, 1 kHz.
36. Repeat steps 26 through 28 with a CF STEP SIZE of 100 kHz substituted in step 27.
37. Repeat steps 23 through 36 for the CW frequencies shown in Table 4-20.

Table 4-20. Phase Noise Test Frequencies

CW Frequency (GHz)	
DUT	LO
6.902	6.901
13.402	13.401
19.502	19.501

**PHASE NOISE CALCULATION**

38. Using the data obtained in Table 4-18 and Table 4-19, calculate and enter the Actual Phase Noise into Table 4-20.

For example: Assume the following data was obtained for the 30 Hz offset at 26.032 GHz

CD = 0 dB (obtained in step 13)

MNL = -50.8 dB (obtained in step 27)

IFCD is defined to be 0 for a 30 Hz offset (also for 100 Hz and 1 kHz)

Therefore

$$\begin{aligned} \text{Actual Phase Noise} &= \text{MNL} + \text{IFCD} - \text{CD} - 3 \text{ dB} \\ &= -50.8 + 0 - 0 - 3 \\ &= -53.8 \end{aligned}$$

The value -53.8 would be entered into Table 4-21.

For example: Assume the following data was obtained for the 10 kHz offset at 2.202 GHz

CD = -25.6 dB (obtained in step 19)

IFCD = -44.2 dB (obtained in step 22)

MNL = -66.0 dB (obtained in step 34)

Therefore

$$\begin{aligned} \text{Actual Phase Noise} &= \text{MNL} + \text{IFCD} - \text{CD} - 3 \text{ dB} \\ &= -66.0 + (-44.2) - (-25.6) - 3 \\ &= -87.6 \end{aligned}$$

The value -87.6 would be entered into Table 4-21.

4-17. SINGLE SIDEBAND PHASE NOISE (Cont'd)

Table 4-21. Phase Noise Test Results

Single Sideband Phase Noise (dBc/1 Hz)								
Offset (Hz)	2.202 GHz		6.902 GHz		13.402 GHz		19.502 GHz	
	Spec	Actual <sup>1</sup>	Spec	Actual <sup>1</sup>	Spec	Actual <sup>1</sup>	Spec	Actual <sup>1</sup>
100	<-67		<-67		<-61		<-57	
1K	<-75		<-75		<-69		<-65	
10K	<-83		<-83		<-77		<-73	
100K	<-107		<-107		<-101		<-97	
Single Sideband Phase Noise (dBc/1 Hz) (Option 007, Improved Phase Noise Specifications)								
Offset (Hz)	2.202 GHz		6.902 GHz		13.402 GHz		19.502 GHz	
	Spec	Actual <sup>1</sup>	Spec	Actual <sup>1</sup>	Spec	Actual <sup>1</sup>	Spec	Actual <sup>1</sup>
30	<-64		<-64		<-58		<-54	
100	<-70		<-70		<-64		<-60	
1K	<-78		<-78		<-72		<-68	
10K	<-86		<-86		<-80		<-76	
100K	<-107		<-107		<-101		<-97	
1. Actual = IFCD <sup>2</sup> - CD - MNL + 3dB 2. IFCD = 0 for 30 Hz, 100 Hz, and 1 kHz offsets = value measured in step 22 (see Table 4-18) for 10K and 100 kHz offsets								

**4-18. POWER SWEEP TEST**

**Specification**

*Table 4-22. Power Sweep Test Specifications*

**Power Sweep**

**Range**

Displayed: 0 to 40 dB/sweep

Actual: At least 10 dB at any given frequency (at least 20 dB in DECOUPLED mode; see Figure A below.)

**Accuracy**

Starting Power Level: Same as Output Power Accuracy

Power Sweep Width and Linearity: See Figure 2 in Table 1-1.

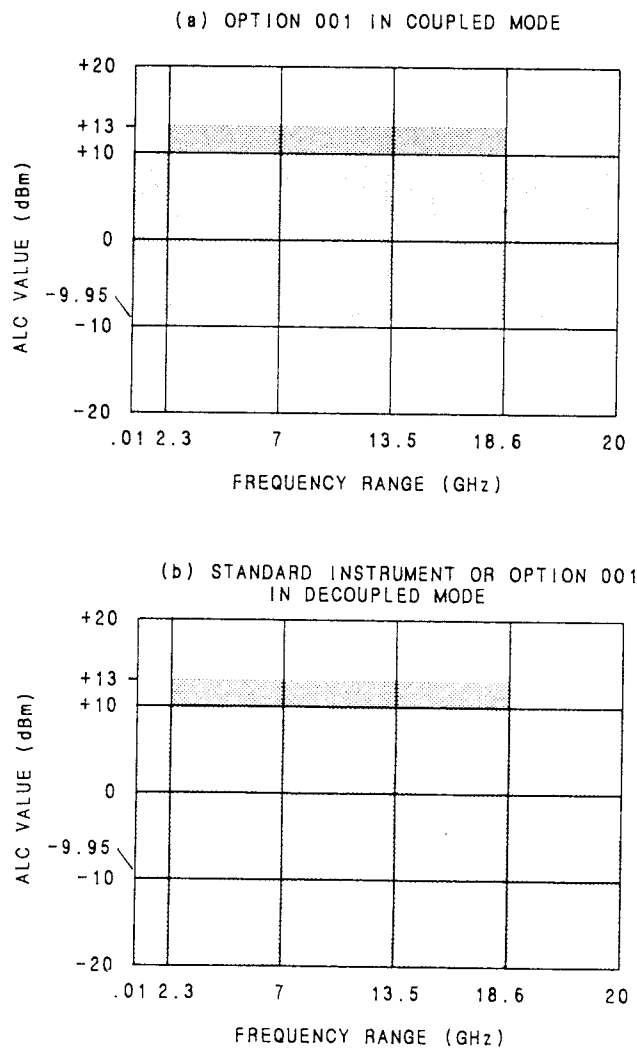

*Figure A. Power Sweep Range*

In instruments equipped with Option 001 (a), the ALC does not operate below  $-9.95$  dBm unless the instrument is placed in the decoupled mode by pressing **[SHIFT] [PWR SWP]**. (see Figure 2 in Table 1-1), and so the maximum power sweep range is the difference of  $-9.95$  dBm and the maximum leveled power available at the frequency of interest (specified leveled power shown in diagram). In the DECOUPLED mode (b), the power sweep range is extended because the ALC can operate down to  $-20$  dBm.

#### 4-18. POWER SWEEP TEST (Cont'd)

##### Description

The ALC in a standard HP 8341A will operate to  $-20$  dBm. However, in normal operation the ALC in an HP 8341A Option 001 (front panel RF output with step attenuator) will only go down to  $-9.95$  dBm, after which the ALC goes to 0 dBm and the step attenuator switches in 10 dB of attenuation. Instruments equipped with Option 004 (Rear Panel RF output with step attenuator) has this same feature. However, with this option the ALC power level will go down to about  $-12$  dBm before it resets to 0 dBm, with the step attenuator switching in attenuation. This operating feature is called the **COUPLED MODE** (the ALC is **coupled** to the step attenuator). To disable this automatic feature place the instrument in the **DECOUPLED** mode by pressing **[SHIFT] [PWR SWP]**. The ALC can now be controlled independently of the step attenuator by means of the front panel **DATA ENTRY** keyboard or **RPG**. The **STEP UP** and **STEP DOWN** keys control the step attenuator in this mode.

The HP 8341A is set to do a 20 dB power sweep from  $-20$  dBm to 0 dBm at a CW frequency (instruments equipped with Option 001 or 004 are placed in the **DECOUPLED** mode to allow this). The HP 8341A is set to do a manual sweep. The HP 8341A output power is measured at the two end points,  $-20$  dBm and 0 dBm, using a power meter.

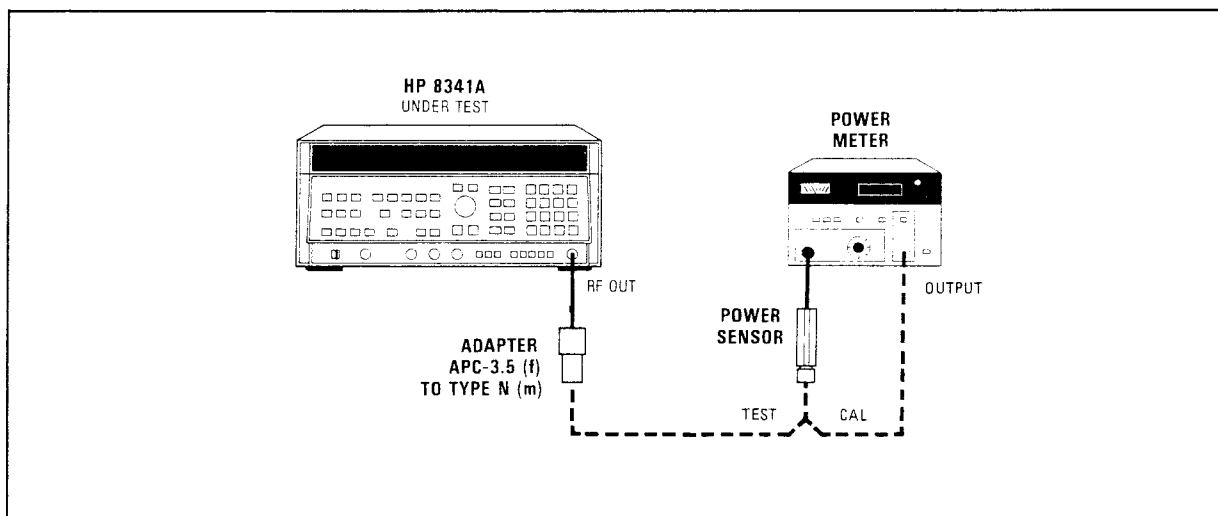

Figure 4-10. Power Sweep Test Setup

##### Equipment

Power Meter .....	HP 436A
Power Sensor .....	HP 8485A
Adapter .....	HP P/N 1250-1744 (APC 3.5 female to Type N (m))

##### Procedure

1. Connect equipment as shown in Figure 4-10. Connect the HP 8485A Power Sensor to the Power Meter. Allow at least 30 minutes warm up time. Set the Power Meter's calibration factor switch to include 1 GHz, then zero and calibrate the Power Meter before connecting the Power Sensor to the HP 8341A.
2. Press HP 8341A **[INSTR PRESET]**. Press the **[CW]** key and enter **[1] [GHz]**.
3. Press **[SHIFT] [PWR SWP]** if necessary to set an HP 8341A Option 001 or 004 to allow the ALC and RF step attenuator to be independently controlled.



**4-18. POWER SWEEP TEST (Cont'd)****NOTE**

**The step up and step down keys control the RF attenuator. The numeric key pad and rotary knob control the ALC power level.**

4. Enter [–] [2] [0] [dBm] ALC power level to set the start of the power sweep at –20 dBm. Press [PWR SWP] and enter [2] [1] [dBm] to set the power sweep range to >20 dB (The maximum power sweep range is from –20 dBm to maximum power).
5. Press the [MANUAL] key. Turn the rotary knob counterclockwise to find the beginning of the power sweep (i.e., the power meter indication is at minimum and no longer changing). Record the power meter indication.

**NOTE**

**The POWER dBm display will indicate the approximate output power during a very slow or manual sweep.**

6. Rotate the rotary knob clockwise to find the end of the power sweep (i.e., the power meter indication is at maximum and no longer changing). Record the power meter indication.
7. The difference between the power meter indications recorded in step 5 and step 6 must be  $\geq 20$  dB.
8. Press the [CW] key and enter [5] [GHz]. Set the power meter's calibration factor switch to include this frequency. Repeat steps 5 through 7 at CW frequencies of 10. and 15 GHz.

**4-19. PULSE MODULATION ON/OFF RATIO TEST**  
**(Applies only to instruments equipped with Option 006, Pulse Modulation)**

**Specification**

*Table 4-23. Pulse Modulation ON/OFF Ratio Test Specifications*

<p>For CW mode and RF frequencies <math>\geq 400</math> MHz only:</p> <p>On/Off Ratio: <math>&gt;80</math> dB</p>
---

**Description**

The HP 8341A (Option 006) under test is set to a CW frequency at 0 dBm. The RF output level is viewed on a spectrum analyzer. A reference level is set on the spectrum analyzer display, the HP 8341A PULSE key is pressed (ON).

**NOTE**

The 50 ohm termination on the HP 8341A (Option 006) PULSE input simulates the RF OFF state when PULSE is selected (ON). In the test set-up below, 2 APC 3.5 (f) to Type N (m) adapters are used with SMA semi-rigid cable. This set-up is used instead of simply connecting the DUT to the HP 8566A/B with a Type N cable because Type N cables have much greater power loss.

The difference between the two spectrum analyzer displayed levels is the pulse ON/OFF ratio.

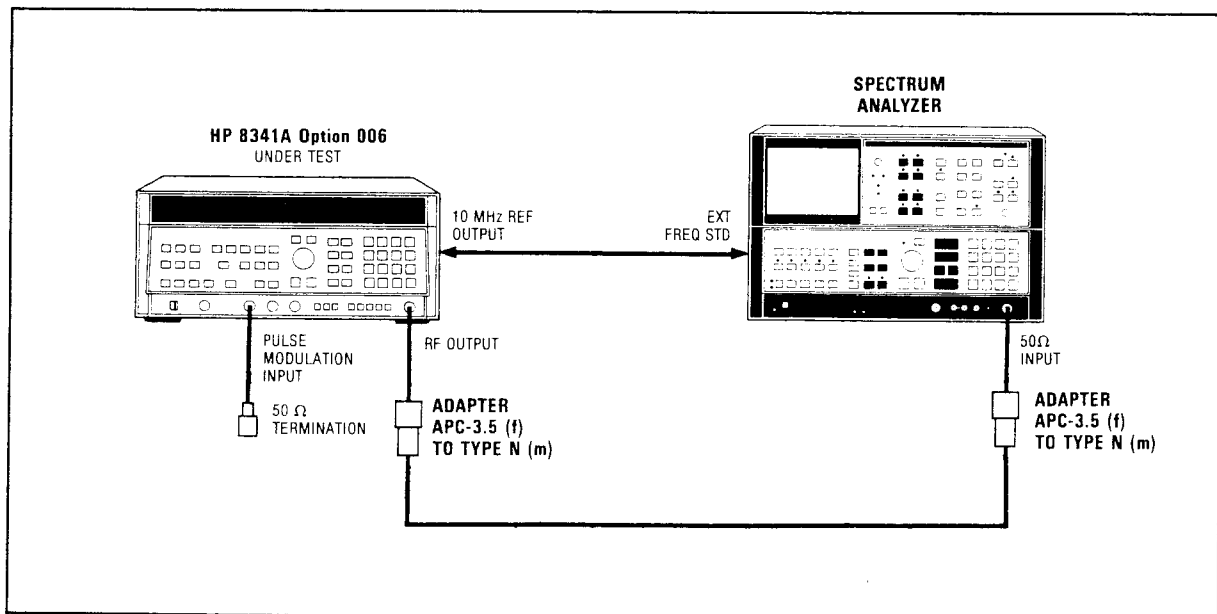

*Figure 4-11. Pulse Modulation ON/OFF Ratio Test Setup*

**Equipment**

- Spectrum Analyzer ..... HP 8566A/B
- 50 Ohm Termination..... HP 10100C
- Cable SMA (m) to SMA (m) ..... HP P/N 08340-20124
- Adapter..... HP P/N 1250-1744
- APC 3.5 (f) to Type N (m) (2 required)

**4-19. PULSE MODULATION ON/OFF RATIO TEST (Cont'd)**  
**(Applies only to instruments equipped with Option 006, Pulse Modulation)**

**Procedure**

1. Connect equipment as shown in Figure 4-11. Allow at least 30 minutes warm up time.
2. Press HP 8341A [**INSTR PRESET**] then [**CW**] and enter [**1**] [**GHz**]. RF power level should be 0 dBm.
3. Set the spectrum analyzer **CENTER FREQUENCY** to equal the HP 8341A CW frequency. **FREQUENCY SPAN** 200 Hz. **RES BW** 30 Hz. **PEAK SEARCH**. **MKR**→**CF**. **MKR**→**REF LVL**. **MKRA**.
4. Press HP 8341A [**PULSE**] key (ON). The spectrum analyzer marker delta amplitude level should be greater than 80 dB.
5. Repeat steps 2 through 4 at CW frequencies of 3, 9, and 15 GHz.

**NOTE**

**For further verification of the ON/OFF Ratio, steps 2 through 4 may be repeated for other frequencies of interest.**

**4-20. PULSE MODULATION RISE AND FALL TIME**  
**(Applies only to instruments equipped with Option 006, Pulse Modulation)**

**Specification**

*Table 4-24. Pulse Modulation Rise and Fall Time Test Specification*

For CW mode and frequencies $\geq 400$ MHz only:
Rise ( $T_R$ ) and Fall ( $T_F$ ) Times: $< 25$ nanoseconds

**Description**

The HP 8341A (Option 006) under test RF output frequency is down converted to 50 MHz using a mixer and a second HP 8341A (or HP 8340A, Option 001) as a local oscillator. The 50 MHz IF signal is amplified and applied to an oscilloscope. The HP 8341A under test is pulsed using a pulse generator. The pulse generator output is also applied to the oscilloscope. The oscilloscope is used to measure the pulse envelope rise and fall times. Refer to Figure 4-12 Pulse Definitions.

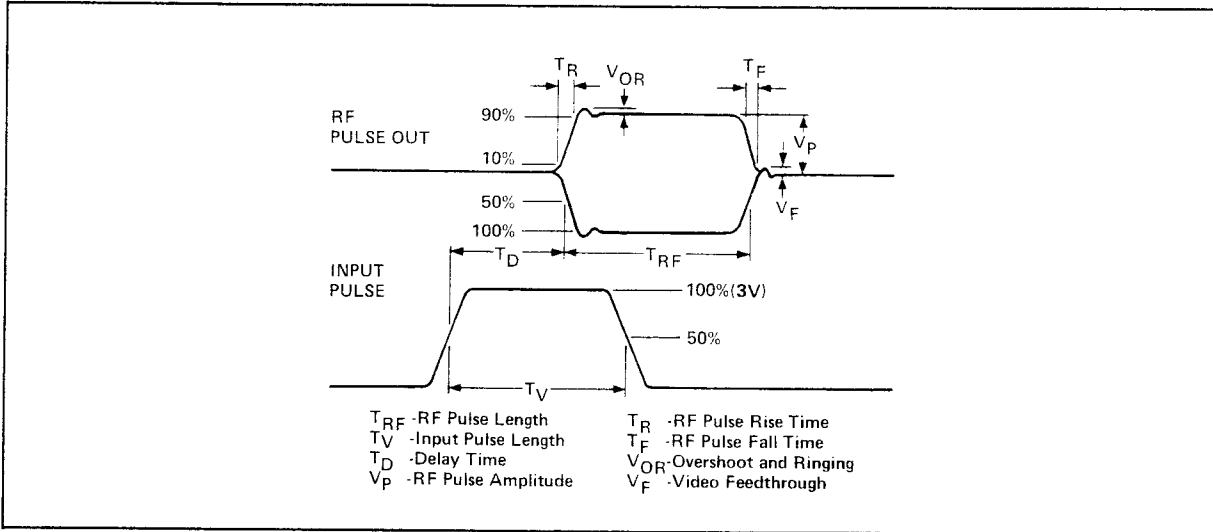

*Figure 4-12. Pulse Definitions*

**Equipment**

Local Oscillator .....	HP 8341A or HP 8340A Opt. 001
Pulse Generator .....	HP 8012B
Amplifier .....	HP 8447F
Oscilloscope .....	HP 1741A
Adapter APC 3.5 (f) to Type N (m).....	HP P/N 1250-1744
Adapter SMA (m) to BNC (f).....	HP P/N 1250-1200
Adapter APC 3.5 (m) to Type N (m) (For HP 8341A LO) ....	HP P/N 1250-1743
10 dB Attenuator .....	HP 8493C Opt. 010
Mixer.....	RHG DMS 1-26
Low Pass Filter (LPF) .....	HP P/N 08340-60176

**Procedure**

1. Connect equipment as shown in Figure 4-13. Connect the mixer directly to the local oscillator RF output to obtain maximum LO drive to the mixer. Connect the BNC tee directly to the HP 8341A PULSE IN connector. Allow at least 30 minutes warm up time.

**4-20. PULSE MODULATION RISE AND FALL TIME (Cont'd)**  
 (Applies only to instruments equipped with Option 006, Pulse Modulation)

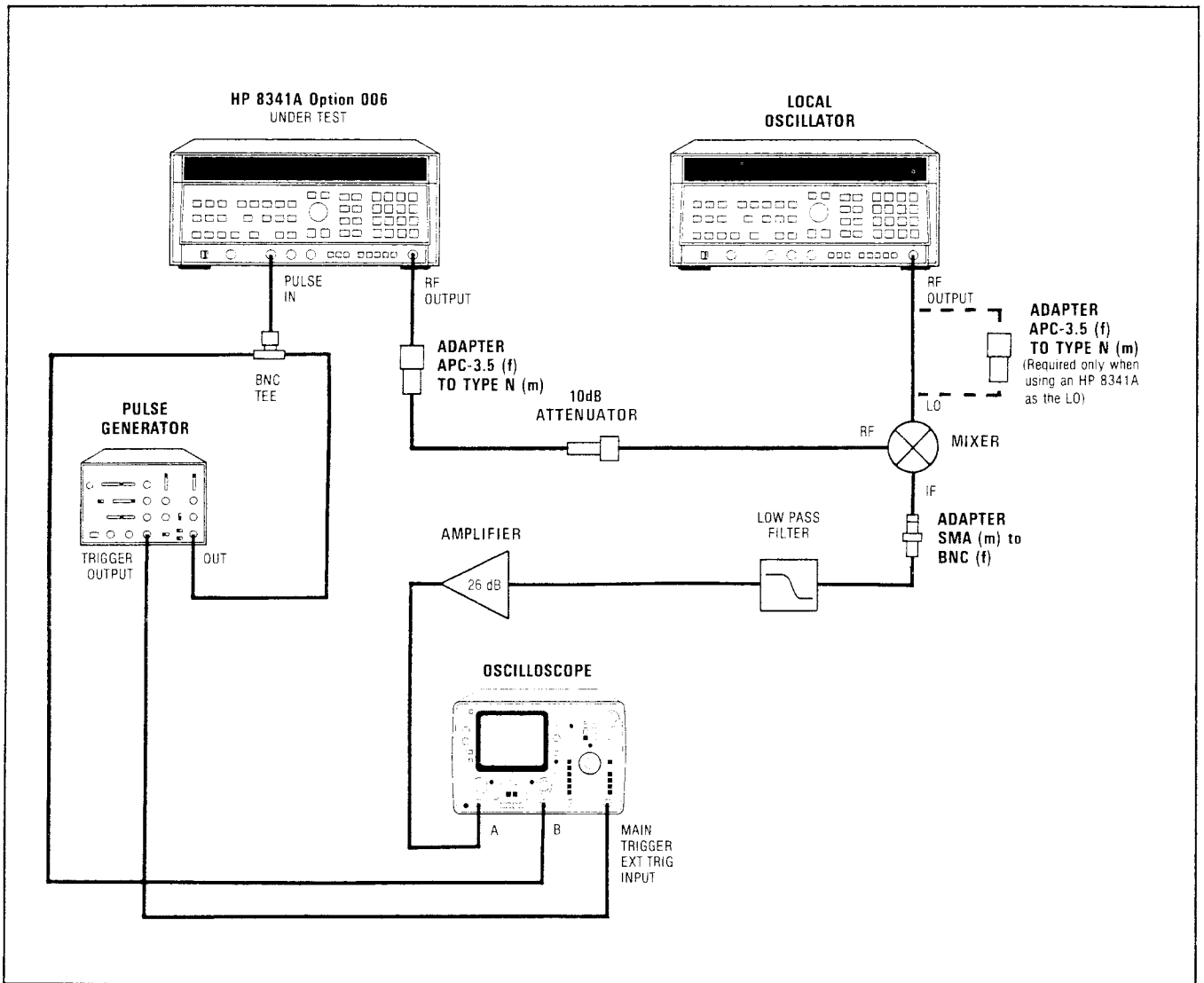

Figure 4-13. Pulse Modulation Rise and Fall Time Test Setup

2. Set up the HP 8012B Pulse Generator as follows:

OFFSET.....	OFF
POLARITY.....	+
OUTPUT.....	NORMAL
INT LOAD.....	IN
PULSE PERIOD slide switch.....	1 $\mu$ –.1m
TRANSITION TIME slide switch.....	minimum (5n)
AMPLITUDE slide switch.....	top position (5.0)
PULSE DOUBLE/NORMAL.....	NORMAL
PULSE DELAY slide switch.....	minimum
Pulse Delay VERNIER.....	fully CCW
LEADING EDGE control.....	fully CCW
PULSE WIDTH slide switch.....	10n–1 $\mu$
TRAILING EDGE control.....	fully CCW

#### 4-20. PULSE MODULATION RISE AND FALL TIME (Cont'd) (Applies only to instruments equipped with Option 006, Pulse Modulation)

3. Set both oscilloscope channels A and B for 50 ohm input. Set the oscilloscope to view the pulse generator output waveform. Adjust the HP 8012B pulse width VERNIER for a 100 nanosecond pulse. Adjust the pulse period VERNIER for a 10 microsecond period. Adjust the amplitude VERNIER for about a 3V pulse amplitude (TTL level). Set the oscilloscope to trigger on this pulse (trigger on channel B)
4. Press [INSTR PRESET] on both the HP 8341A under test and the local oscillator HP 8341A. Press the HP 8341A under test [CW] key and enter [1] [GHz] and press the [PULSE] modulation key. Press the local oscillator HP 8341A [CW] key and enter [.] [9] [5] [GHz]. The IF frequency is then 50 MHz. Set the local oscillator HP 8341A for +10 dBm or maximum leveled output. The HP 8341A under test RF power should be 0 dBm.

#### NOTE

**For best accuracy in this test, the Local Oscillator drive to the mixer should be  $\geq +6$  dBm. An HP 8340A Option 001 used as the LO will typically produce +10 dBm from 10 MHz to 20 GHz. An HP 8341A (Std) will produce +10 dBm over its entire frequency range.**

5. Set the oscilloscope horizontal for 50 nanoseconds/division and select channel A input only. Adjust the channel A (pulsed IF input signal) vertical gain and position so that the pulse OFF is at the 0% graticule line and the pulse ON is at 100% graticule line. Select the horizontal MAG X10. The oscilloscope is now calibrated for 5 nanoseconds/division. Adjust the horizontal position control to position the modulation envelope so that the 10% point of the envelope rise time is at the center vertical graticule line similar to Figure 4-14.

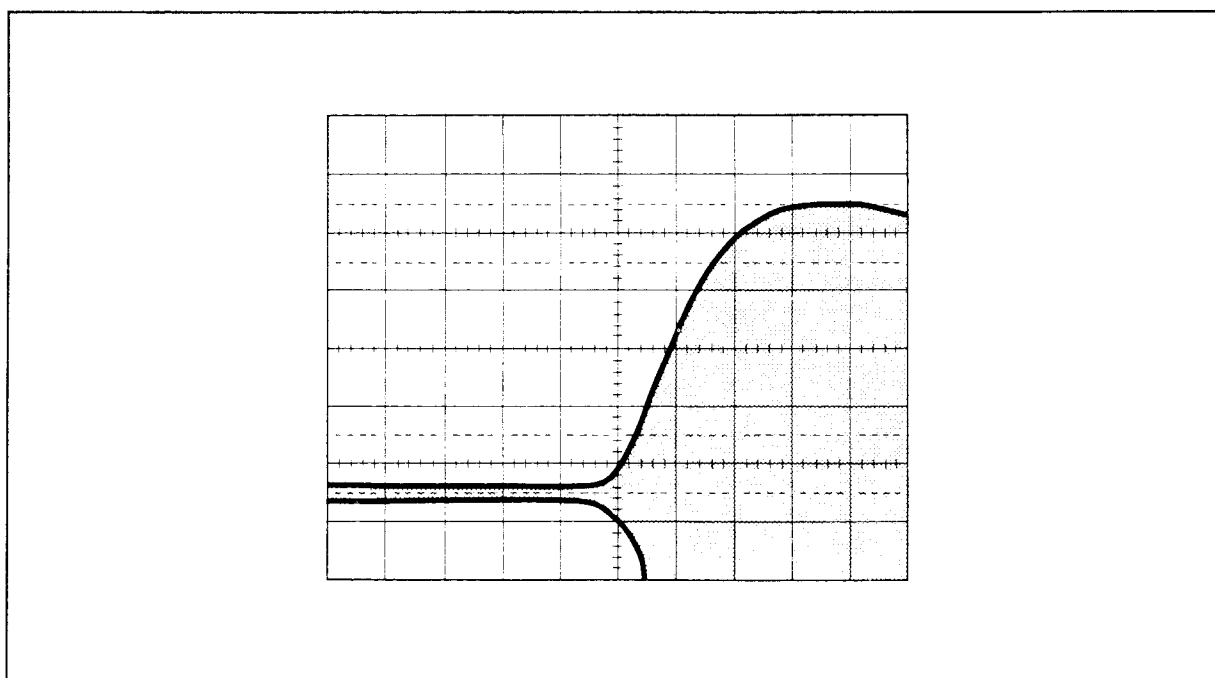

Figure 4-14. Pulse Modulation Rise Time Waveform

**4-20. PULSE MODULATION RISE AND FALL TIME (Cont'd)**  
(Applies only to instruments equipped with Option 006, Pulse Modulation)

6. The 90% point of the envelope rise time should be less than 25 nanoseconds (5 horizontal divisions) from the 10% point.
7. Adjust the oscilloscope horizontal position control to view the modulation envelope fall time. Position the waveform so that the modulation envelope crosses the 90% graticule at a vertical graticule line similar to Figure 4-15.

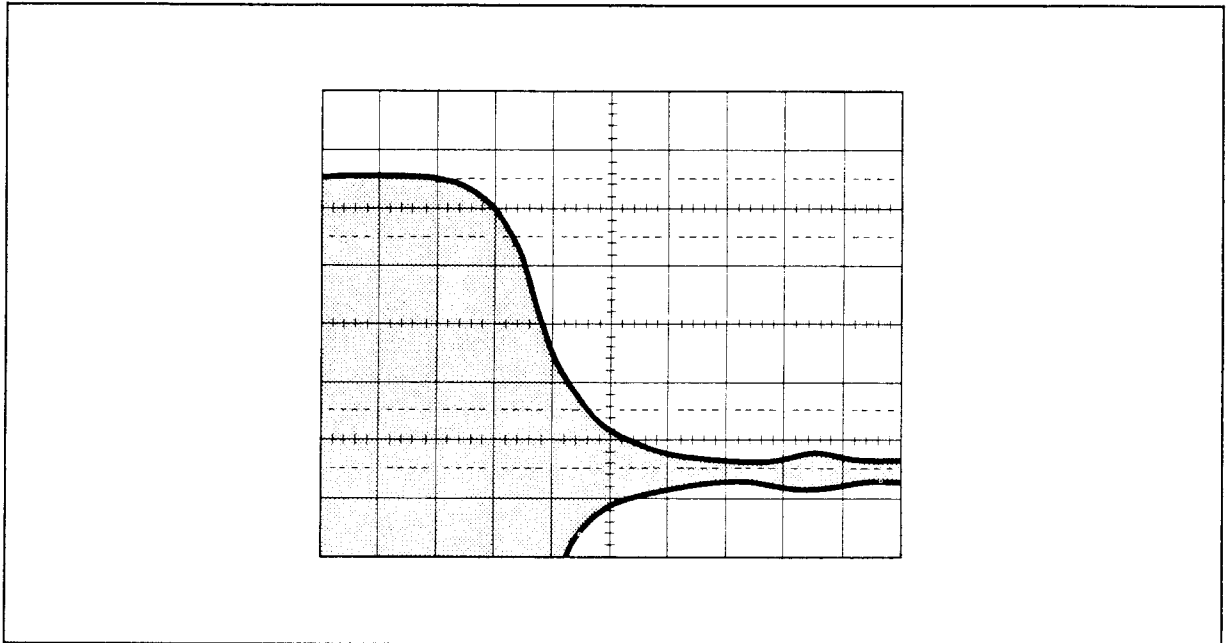

Figure 4-15. Pulse Modulation Fall Time Waveform.

8. The 10% point should be <25 nanoseconds (5 divisions) from the 90% point.
9. Repeat steps 5 through 8 at CW frequencies of 3, 9, and 15 GHz. Set the local oscillator HP 8341A CW frequency to be 50 MHz below the HP 8341A under test frequency.

**4-21. PULSE MODULATION ACCURACY TEST**  
**(Applies only to instruments equipped with Option 006, Pulse Modulation)**

**Specification**

*Table 4-25. Pulse Modulation Accuracy Test Specification*

For CW mode and frequencies  $\geq 400$  MHz only:

Minimum Internally Leveled RF Pulse Width (TL RFI): 100 nanoseconds

Pulse Repetition Frequency

Internally leveled: 100 Hz to 5 MHz

Accuracy of Internally Leveled RF Pulse VI, PI (relative to CW mode level):

**NOTE**

**ALC attempts to hold pulse amplitude to same level as leveled CW signal.**

<b>Bands and Approximate Frequency Ranges (GHz)</b> (see Frequency Ranges and Bandswitch Points for complete description)		
<b>Pulse Width</b>	<b>Band 0 0.4 to &lt;2.3</b>	<b>Bands 1-3 2.3 to 20.0</b>
100 to <200 ns	+3/-0.3 dB*	+1.5/-0.3 dB*
200 to <500 ns	+1.5/-0.3 dB*	$\pm 0.3$ dB
$\geq 500$ ns	$\pm 0.3$ dB	$\pm 0.3$ dB
* +15 to +55°C. Duty Cycle must be $> 0.01\%$ .		

**Description**

The HP 8341A (Option 006) under test RF output frequency is down converted to 50 MHz using a mixer and a second HP 8341A (or an HP 8340A, Option 001) as a local oscillator. The 50 MHz IF signal is amplified and applied to an oscilloscope. The HP 8341A under test is pulsed using a pulse generator. The IF modulation envelope is positioned to convenient horizontal graticule lines. The pulse is turned OFF and the HP 8341A output power level is adjusted so that the IF carrier is at the horizontal graticule lines established when the HP 8341A was being pulsed. The change in HP 8341A output power level is the accuracy error of the leveled RF pulse.

**Equipment**

- Local Oscillator ..... HP 8341A or HP 8341A Opt. 001
- Pulse Generator ..... HP 8012B
- Amplifier ..... HP 8447F
- Oscilloscope ..... HP 1741A
- Adapter APC 3.5 (m) to Type N (m) (for HP 8341A LO)... HP P/N 1250-1743
- Adapter APC 3.5 (f) to Type N (m)..... HP P/N 1250-1744
- Adapter SMA (m) to BNC (f)..... HP P/N 1250-1200
- 10 dB Attenuator ..... HP 8493C Opt. 010
- Mixer..... RHG DMS 1-26
- Low Pass Filter (LPF) ..... HP P/N 08340-60176



**4-21. PULSE MODULATION ACCURACY TEST (Cont'd)**  
 (Applies only to instruments equipped with Option 006, Pulse Modulation)

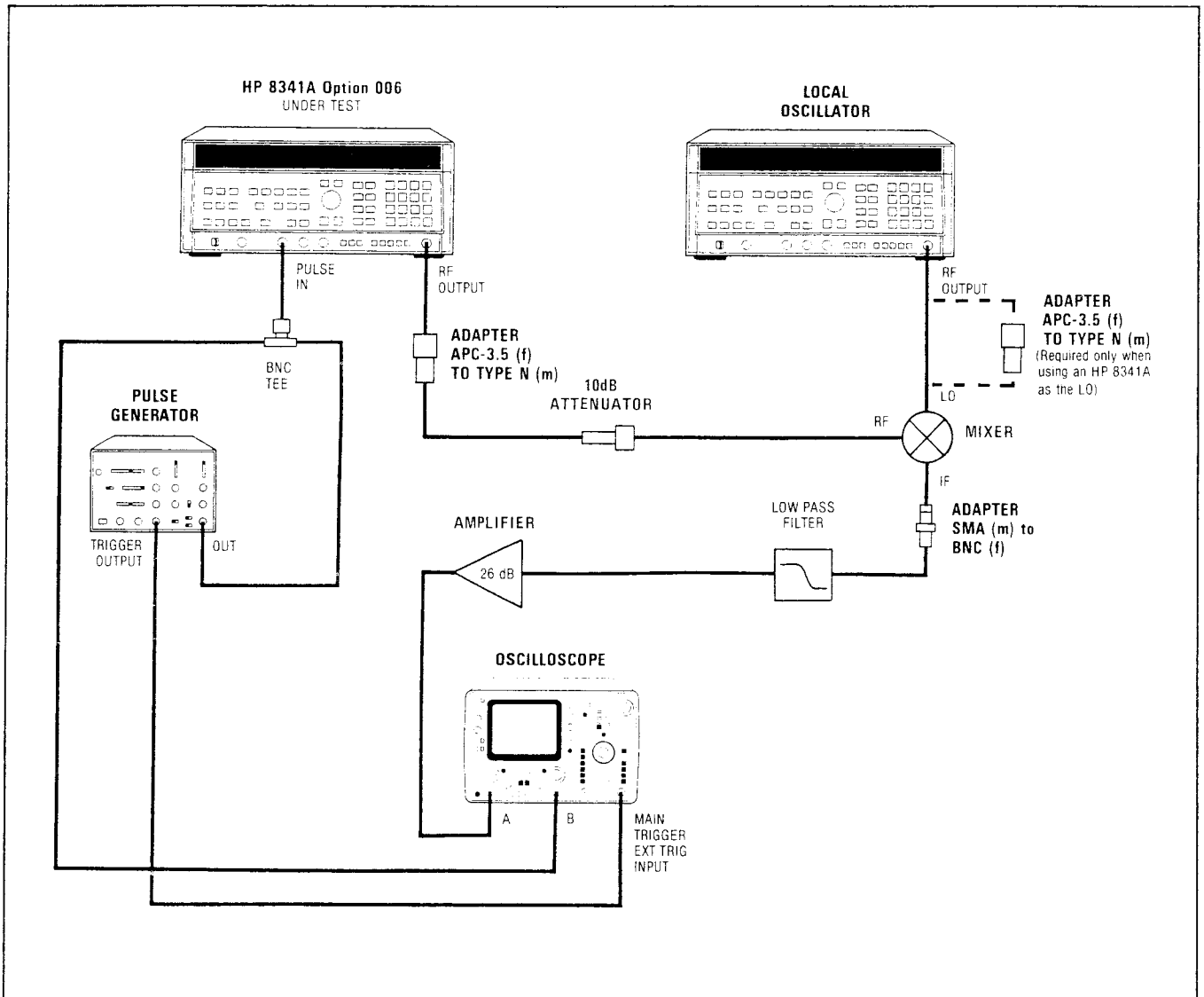

Figure 4-16. Pulse Modulation Accuracy Test Setup

**Procedure**

1. Connect equipment as shown in Figure 4-16. Connect the mixer directly to the LO HP 8341A RF output connector to obtain the maximum mixer LO input level. Connect the BNC tee directly to the HP 8341A PULSE IN connector. Allow at least 30 minutes warm up time.

#### 4-21. PULSE MODULATION ACCURACY TEST (Cont'd) (Applies only to instruments equipped with Option 006, Pulse Modulation)

- Set up the HP 8012B Pulse Generator as follows:

PULSE PERIOD slide switch	1 $\mu$ –.1m
TRANSITION TIME slide switch	minimum (5n)
AMPLITUDE slide switch	top position (5.0)
PULSE DOUBLE/NORMAL	NORMAL
PULSE DELAY slide switch	minimum
Pulse Delay VERNIER	fully CCW
LEADING EDGE control	fully CCW
PULSE WIDTH slide switch	10n-1 $\mu$
TRAILING EDGE control	fully CCW
OFFSET	OFF
POLARITY	+
OUTPUT	NORMAL
INT LOAD	IN

- Set both oscilloscope channels (A and B) for 50 Ohm input. Set the oscilloscope to view the pulse generator output waveform. Adjust the HP 8012B pulse width VERNIER for a 100 nanosecond pulse. Adjust the pulse period VERNIER for a 10 microsecond period. Adjust the amplitude VERNIER for about a 3V pulse amplitude (TTL level).
- Press [**INSTR PRESET**] on both the HP 8341A under test and the local oscillator. Press the HP 8341A under test [**CW**] key and enter [**1**] [**GHz**]. Press [**POWER LEVEL**] and enter [**-**] [**1**] [**0**] [**dBm**]. Press the local oscillator [**CW**] key and enter [**.**] [**9**] [**5**] [**GHz**]. The IF frequency is then 50 MHz. Set the local oscillator for +10 dBm or maximum leveled output.
- Set the oscilloscope horizontal for 50 nanoseconds/division and select channel A input only. Adjust the channel A (IF carrier input signal) vertical sensitivity to view the entire RF envelope.

#### NOTE

**It may be necessary to reduce the vertical sensitivity and/or adjust the HP 8341A RF output level at some frequencies.**

- Press the [**PULSE**] key on the HP 8341A under test (pulse ON). Adjust the oscilloscope vertical position and sensitivity to place the modulation envelope on convenient horizontal graticule lines. Press the [**PULSE**] key to turn pulse OFF. Press the [**POWER LEVEL**] key on the HP 8341A under test. Note the power level in the **ENTRY DISPLAY**.
- Adjust the HP 8341A under test power level using the rotary knob so that the IF carrier signal aligns with the horizontal graticule lines established in step 6 for the modulation envelope. Note the **ENTRY DISPLAY** power level.
- The difference between the power levels noted in step 6 and 7 should be less than the specification for this pulse width and RF frequency.
- Repeat steps 5 through 8 for pulse widths of 200, 500, and 1000 nanoseconds.

**4-21. PULSE MODULATION ACCURACY TEST (Cont'd)**  
**(Applies only to instruments equipped with Option 006, Pulse Modulation)**

10. To test the Pulse Repetition Frequency range (100 Hz to 5 MHz), set the pulse generator period to 10 milliseconds (100 Hz) and pulse width to 1 microsecond (duty cycle of 0.01%). Repeat steps 5 through 8. Set the pulse generator period to 200 nanoseconds (5 MHz) and pulse width to 100 nanoseconds (minimum specified PW). Repeat steps 5 through 8.
11. Set the pulse generator period to 10 microseconds and pulse width to 100 nanoseconds. Repeat steps 5 through 10 at CW frequencies of 3, 9, and 15 GHz. Set the local oscillator CW frequency to be 50 MHz below the HP 8341A under test frequency. For the HP 8341A 15 GHz test frequency, press [**PEAK**] to ON.

**4-22. PULSE MODULATION VIDEO FEEDTHROUGH TEST  
(Applies only to instruments equipped with Option 006, Pulse Modulation)**

**Specification**

*Table 4-26. Pulse Modulation Video Feedthrough Test Specification*

<p>For CW mode and frequencies <math>\geq 400</math> MHz only:</p> <p>Video Feedthrough (<math>V_F/V_P</math>):</p> <p>0.4 to <math>&lt;2.3</math> GHz (Band 0): <math>&lt;5\%</math> for output power levels <math>\leq +8</math> dBm  2.3 to 20.0 GHz (Bands 1-3): <math>\leq 0.2\%</math></p>
--

**Description**

**NOTE**

**Video feedthrough is any component of the pulse generator signal that appears at the HP 8341A RF output connector.**

The HP 8341A (Option 006) under test is set to a CW frequency at 0 dBm. The HP 8341A is pulsed using a pulse generator. The pulsed RF output signal is fed through a 10 dB attenuator and a low pass filter that will pass only the low frequency (video feedthrough) component of the modulation envelope. The video feedthrough is measured using an oscilloscope. The measured voltage is related to the RF power by:

$$P = 10 \log (V^2/R/1 \text{ mW})$$

Where:

P = HP 8341A RF output level minus 10 dB, and

R = 50 Ohms.

**Equipment**

Pulse Generator .....	HP 8012B
Oscilloscope .....	HP 1741A
Adapter APC 3.5 (f) to Type N (m) .....	HP 1250-1744
Adapter SMA (m) to BNC (f).....	HP P/N 1250-1200
10 dB Attenuator .....	HP 8493C Opt. 010
Low Pass Filter (LPF) .....	HP P/N 08340-60176

**Procedure**

1. Connect equipment as shown in Figure 4-17. Attach the BNC tee directly to the HP 8341A PULSE input connector. Allow at least 30 minutes warm up time.

**4-22. PULSE MODULATION VIDEO FEEDTHROUGH TEST (Cont'd)**  
 (Applies only to instruments equipped with Option 006, Pulse Modulation)

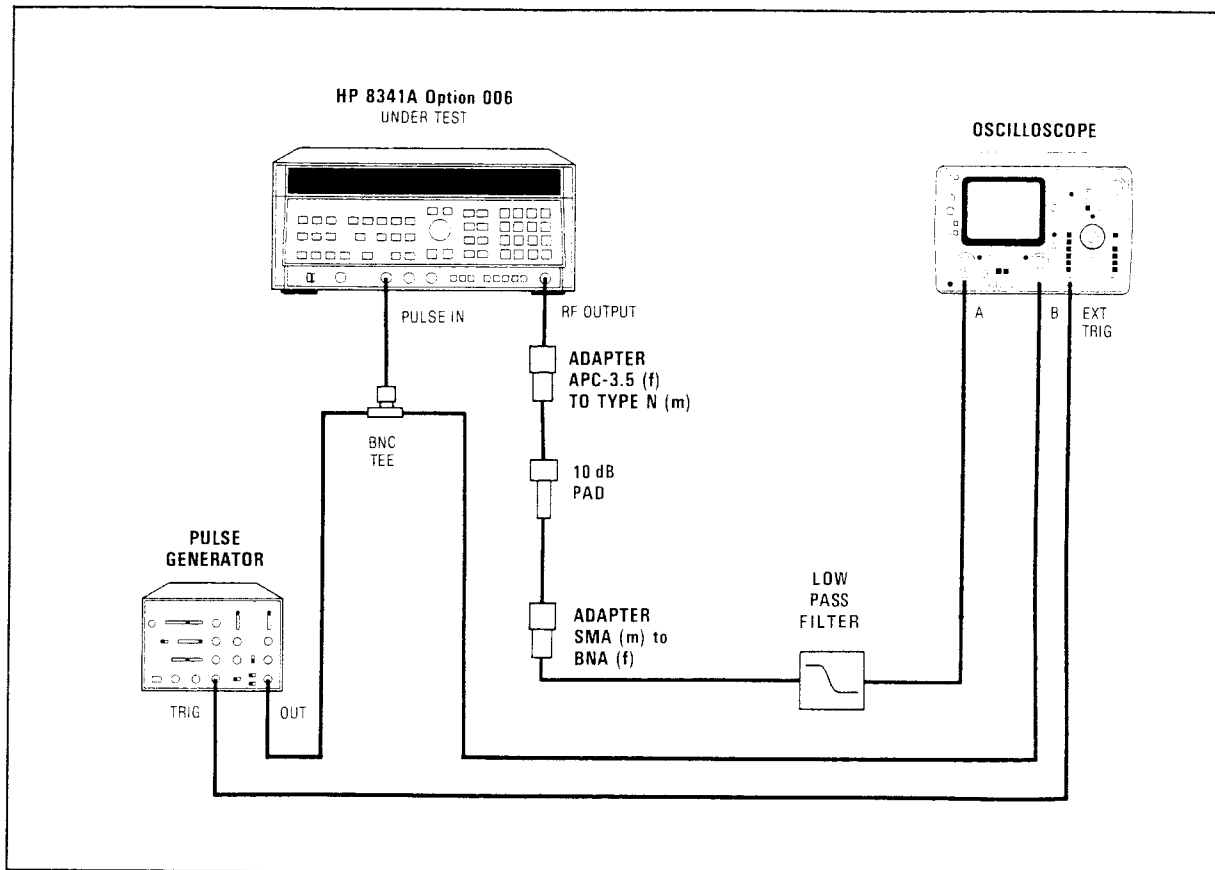

Figure 4-17. Pulse Modulation Video Feedthrough Test Setup

2. Set up the HP 8012B Pulse Generator as follows:

PULSE PERIOD slide switch	.....	1μ-1m
TRANSITION TIME slide switch	.....	minimum (5n)
AMPLITUDE slide switch	.....	top position (5.0)
PULSE DOUBLE/NORMAL	.....	NORMAL
PULSE DELAY slide switch	.....	minimum
Pulse Delay VERNIER fully	.....	CCW
LEADING EDGE control	.....	fully CCW
PULSE WIDTH slide switch	.....	10n-1μ
TRAILING EDGE control	.....	fully CCW
OFFSET	.....	OFF
POLARITY	.....	+
OUTPUT	.....	NORMAL
INT LOAD	.....	IN

3. Set both oscilloscope channels (A and B) to 50 Ohm input. Set the oscilloscope to view the pulse generator output waveform. Adjust the HP 8012B pulse width VERNIER for a 100 nanosecond pulse. Adjust the pulse period VERNIER for a 100 microsecond period. Adjust the amplitude VERNIER for about a 3V pulse amplitude (TTL level). Set the oscilloscope horizontal for 50 nanoseconds/division and select channel A input only.
4. Press [INSTR PRESET] on the HP 8341A under test. Press the HP 8341A [CW] key and enter [.] [5] [GHz]. Press the [PULSE] key (pulse ON).
5. Press the [POWER LEVEL] key enter the first power level. [8] [dBm].

**4-22. PULSE MODULATION VIDEO FEEDTHROUGH TEST (Cont'd)**  
**(Applies only to instruments equipped with Option 006, Pulse Modulation)**

6. Adjust the oscilloscope channel A vertical sensitivity and vertical position to view the video feedthrough signal similar to Figure 4-18.

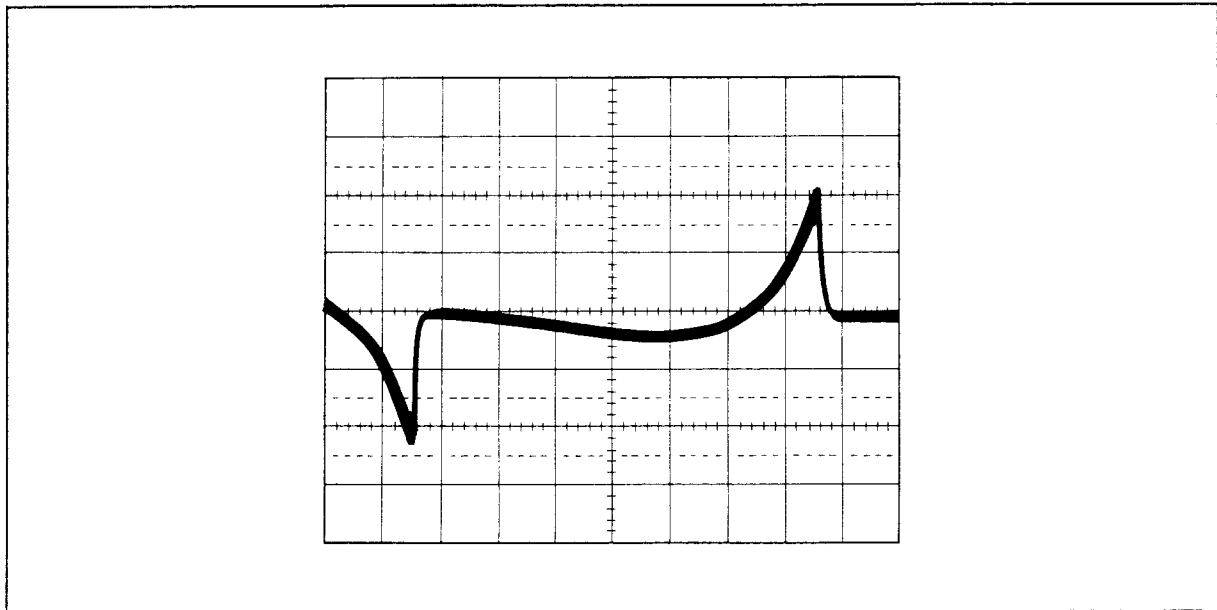

*Figure 4-18. Pulse Modulation Video Feedthrough Waveform*

7. The test limits for the three power levels are shown in Table 4-27. (Note that the test limit is 5% of Vpk.)

*Table 4-27. Pulse Modulation Video Feedthrough Test Limits*

HP 8341A RF Output Level (dBm)	P = (dBm)	Vpk	TEST LIMIT (pk voltage)
+8	-2	0.2511	12 mV
0	-10	0.0999	5 mV
-10	-20	0.03162	1.6 mV

The test limits are derived using the following equation:

$$P = 10 \log (V_{rms}^2/R/1 \text{ mW})$$

Where:

P = HP 8341A RF koutput level -10 dB, and,

R = 50 Ohms.

#### 4-22. PULSE MODULATION VIDEO FEEDTHROUGH TEST (Cont'd) (Applies only to instruments equipped with Option 006, Pulse Modulation)

Example:

For HP 8341A set to 0 dBm the output of the 10 dB pad is  $-10$  dBm.

$$P = 10 \log (V_{\text{rms}}^2/R/1 \text{ mW})$$

$$-10 = 10 \log (V_{\text{rms}}^2/50/0.001) \quad (\text{divide through by } 10)$$

$$-1 = \log (V_{\text{rms}}^2/50/0.001) \quad (\text{take antilog of both sides})$$

$$10^{-1} = 0.1 = (V_{\text{rms}}^2/50/0.001) \quad (\text{cross multiply})$$

$$0.0001 = V_{\text{rms}}^2/50 \quad (\text{cross multiply again})$$

$$\sqrt{0.005} = V_{\text{rms}} = 0.0707 \text{ rms}$$

$$\text{Test Limit} = V_{\text{pk}} \times 5\% = 0.0707 \times 1.414 \times 5\% = 5 \text{ mV}$$

8. Repeat steps 6 and 7 for HP 8341A output power levels of 0 and  $-10$  dBm.
9. Repeat steps 5 through 8 at CW frequencies of 1, 1.5 and 2 GHz.

#### NOTE

**For HP 8341A frequencies above 2.3 GHz the video feedthrough is typically so small that it is difficult to measure. The following steps provide a means to verify that the video feedthrough is negligible.**

10. Remove the 10 dB pad between the HP 8341A Under Test and low pass filter. Press the HP 8341A **[CW]** key and enter any frequency from  $>2.3$  GHz to 20 GHz. Press the **[POWER LEVEL]** key and enter **[-] [1] [0] [dBm]**.
11. Select the oscilloscope X5 vertical magnifier. The test limit is now 0.2 mV or 1 minor division on the oscilloscope.
12. Select several HP 8341A CW frequencies  $>2.3$  GHz and verify that the video feedthrough is less than 1 minor division on the oscilloscope.

**4-23. AMPLITUDE MODULATION TEST**

**Specification**

*Table 4-28. Amplitude Modulation Test Specifications*

<p>The following specifications apply when the HP 8341A is internally leveled, for waveforms whose envelope peak is at least 1 dB below maximum specified power. Unless noted, pulse modulation must be OFF; however, the HP 8341A (Option 006) is capable of simultaneous amplitude and pulse modulation. See Section III. Operation.</p> <p>AM Depth: 0 to 90%</p> <p>AM Sensitivity at 1 kHz rate and 30% depth: 100%/Volt <math>\pm</math> 5%</p> <p>AM Bandwidth relative to 1 kHz rate at 30% Depth:DC coupled, 3 dB point <math>\geq</math> 100 kHz</p> <p>AM Frequency Response (Flatness) Relative to a 1 kHz rate at 30% depth, DC to 10 kHz: <math>\pm</math>0.20 dB</p>
---

**Description**

AM sensitivity and accuracy is determined by simulating a modulation signal (i.e., setting the function generator to a dc voltage). The unmodulated HP 8341A RF output is measured using a power meter. A dc voltage representing  $\pm$ 30% modulation ( $\pm$ 0.3 Vdc) is applied to the HP 8341A under test AM input. The power meter indication should change by:

$$20 \log (1 + (\text{dc voltage} \pm (0.05 \text{ times the dc voltage})))$$

The sensitivity and accuracy is tested at several HP 8341A CW frequencies.

The AM frequency response and bandwidth is measured by down converting the HP 8341A under test RF frequency to an IF frequency within the range of the modulation analyzer. The HP 8341A is amplitude modulated using a function generator. The modulation analyzer is set to indicate 0 dB at the reference modulation frequency of 1 kHz. The modulation frequency is varied and the flatness is indicated on the modulation analyzer. The modulating frequency is then set to the bandwidth specification (100 kHz) and the modulation analyzer should indicate  $> -3$  dB. This shows that the actual 3 dB point will occur at a frequency  $>100$  kHz.

Finally, the function generator output level is increased to obtain  $>90\%$  modulation depth.

**Equipment**

Local Oscillator.....	HP 8341A or HP 8340A Opt. 001
Modulation Analyzer.....	HP 8901A
Function Generator.....	HP 3325A
Digital Voltmeter.....	HP 3455A
Amplifier.....	HP 8447F
Power Meter.....	HP 436A
Power Sensor.....	HP 8485A
Adapter APC 3.5 (f) to Type N (m).....	HP P/N 1250-1744
Adapter APC 3.5 (m) to Type N (m) (for HP 8341A LO)....	HP P/N 1250-1743
Adapter SMA (m) to BNC (f).....	HP P/N 1250-1200
Adapter type N (m) to BNC (f).....	HP P/N 1250-1476
20 dB Attenuator.....	HP 8493C Opt. 020
Mixer.....	RHG DMS 1-26



4-23. AMPLITUDE MODULATION TEST (Cont'd)

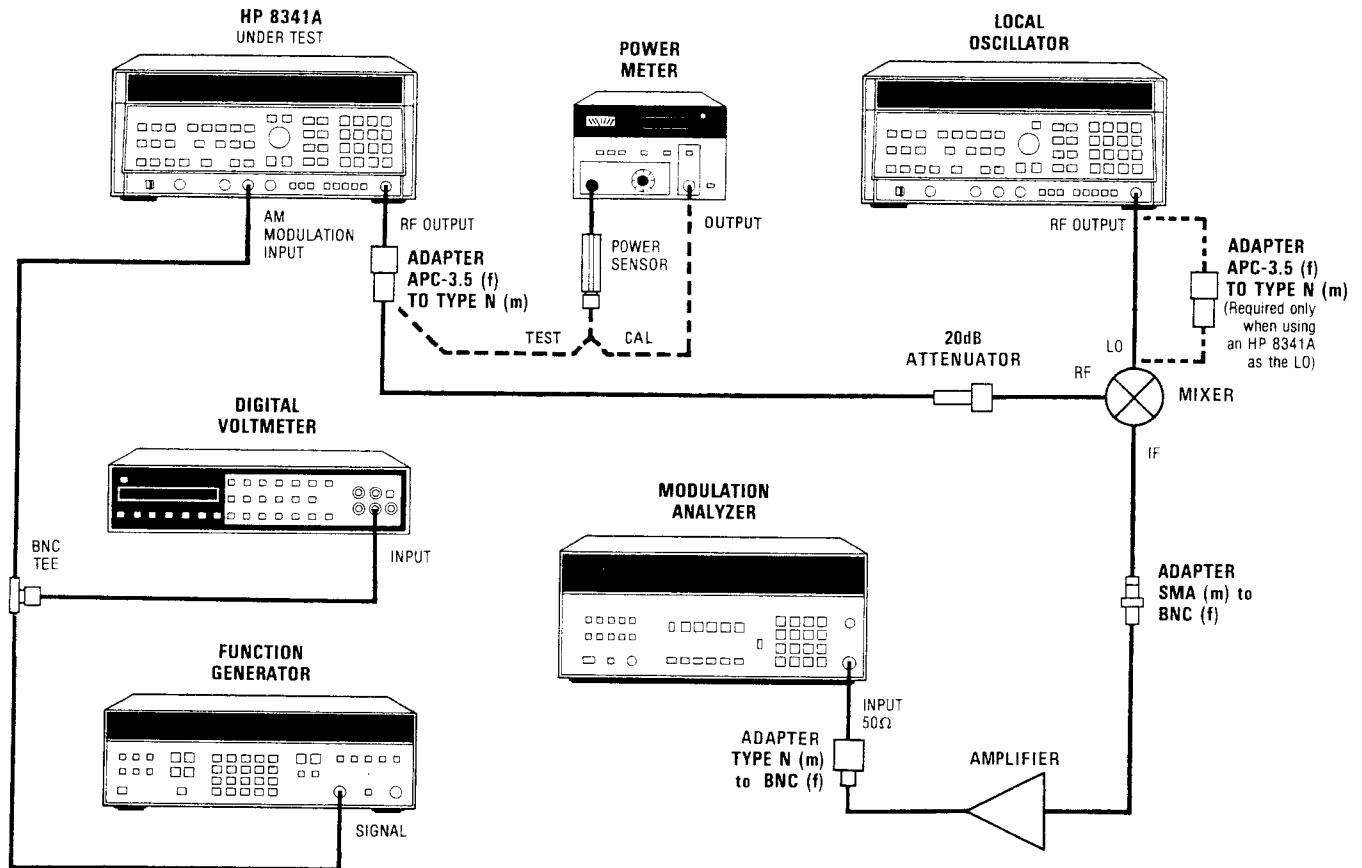

Figure 4-19. Amplitude Modulation Test Setup

**Procedure**

**AM SENSITIVITY AND ACCURACY**

1. Connect equipment as shown in Figure 4-19. Connect the mixer LO port at the local oscillator HP 8341A RF output. Connect the HP 8485A Power Sensor to the power meter. Allow at least 30 minutes warm up time. Set the power meter's calibration factor switch to include 1.5 GHz, then zero and calibrate the power meter. Connect the power sensor to the HP 8341A under test RF output.
2. Press HP 8341A under test [INSTR PRESET]. Press the [CW] key and enter [1] [.] [5] [GHz]. Press the [POWER LEVEL] key and enter [-] [5] [dBm].

**NOTE**

The function generator output impedance is 50 Ohms and its output indication accuracy assumes a 50 Ohm load. The HP 8341A AM input impedance is 600 Ohms; therefore, a high impedance DVM is used to measure and set the function generator output level.

**4-23. AMPLITUDE MODULATION TEST (Cont'd)**

3. Zero the power meter as follows:

With power applied to the sensor, press the power meter RANGE HOLD. Press the HP 8341A [RF] key to turn the RF OFF. Zero the power meter. Press the [RF] key to turn the RF ON.

4. Using the DVM as an indicator, set the function generator to output 0 Vdc (If the function generator being used does not have this feature, use a dc power supply). Press the HP 8341A under test [AM] key (AM ON). Note the power meter indication.
5. Simulate +30% modulation by setting the function generator output to +0.3 volts dc as indicated on the DVM. The power meter indication should increase by 2.18 to 2.38 dB from the value noted in step 4.

$$20 \log (1 + (0.3 - (0.05 \text{ times } 0.3))) = 2.18 \text{ dB}$$

to

$$20 \log (1 + (0.3 + (0.05 \text{ times } 0.3))) = 2.38 \text{ dB}$$

6. Simulate -30% modulation by setting the function generator output to -0.3 volts dc as indicated on the DVM. The power meter should decrease by 2.91 to 3.29 dB from the value noted in step 4.

$$20 \log (1 + (-0.3 - (0.05 \text{ times } -0.3))) = -2.91 \text{ dB}$$

to

$$20 \log (1 + (-0.3 + (0.05 \text{ times } -0.3))) = -3.29 \text{ dB}$$

**NOTE**

**The HP 8341A test power levels are selected to avoid power meter range changes at the +30 and -30% modulation settings.**

7. Press the HP 8341A under test [POWER LEVEL] key and enter [+] [5] [dBm]. Press the [AM] key to turn AM OFF. Repeat steps 3 through 6 for this HP 8341A power level setting.
8. Press the HP 8341A under test [CW] key and enter [4] [.] [5] [GHz]. Press the [AM] key to turn AM OFF. Set the power meter's calibration factor switch to include 4.5 GHz. Repeat steps 3 through 6 for HP 8341A power level settings of -5 and +5 dBm.

**AM FREQUENCY RESPONSE AND BANDWIDTH**

9. Disconnect the power sensor and connect the HP 8341A under test RF output to the 20 dB attenuator.
10. Press the HP 8341A under test [CW] key and enter [1] [.] [5] [GHz]. Press the [POWER LEVEL] key and enter [0] [dBm]. Press the local oscillator INSTR PRESET, CW and enter 1.45 GHz. Press POWER LEVEL, enter 10 dBm, and press PEAK (ON). (The output may be unlevelled; this will not affect the test.) The IF frequency is now 50 MHz.

**NOTE**

**For best accuracy in the Amplitude Modulation test, the Local Oscillator drive to the mixer should be  $\geq +6$  dBm. An HP 8340A Option 001 used as the LO will typically produce +10 dBm from 10 MHz to 20 GHz. An HP 8341A (std.) will produce +10 dBm over its entire frequency range.**

**4-23. AMPLITUDE MODULATION TEST (Cont'd)**

11. Set the function generator for a sine wave at a reference frequency of 1 kHz at 0.2121 Vrms (0.3 times 0.707)  $\pm 0.05$  Vrms. For example: 0.25 Vrms, as indicated on the DVM, would fall in this range. Set the modulation analyzer input frequency to 50 MHz (by pressing **FREQ 50 MHz**), then press **AM** and **AVE** on the HP 8901A. The modulation analyzer should indicate about 21%. Note the DVM indication.
12. Press the **dB** key. As the modulating frequency is changed the modulation analyzer will indicate the flatness in dB relative to the 1 kHz reference.
13. Set the function generator to 100, 200, 500 Hz, then 1, 2, 5, and 10 kHz. Check the DVM indication and adjust the level of the modulating signal at each frequency to eliminate any flatness error of the function generator. Observe the flatness indication on the modulation analyzer. The flatness indication should be  $\leq \pm 0.20$  dB.
14. Check the AM bandwidth by setting the function generator to 100 kHz. Adjust the function generator output level to the value noted in step 11. The modulation analyzer should indicate  $\geq -3$  dB.

**AM DEPTH**

15. Set the function generator to 1 kHz. Set the modulation analyzer to indicate percent modulation by setting the controls as follows:

AUTOMATIC OPERATION .....	ON
AM .....	ON
RATIO % .....	OFF
RATIO dB .....	OFF
PEAK .....	+

Increase the function generator output amplitude to obtain  $>90\%$  modulation depth.

16. Repeat steps 11 through 15 at HP 8341A RF frequencies of 3, 9, and 15 GHz. Set the local oscillator HP 8341A CW frequency to be 50 MHz below the HP 8341A under test frequency.

**4-24. HP 8341A HP-IB OPERATION VERIFICATION TEST**

**NOTE**

**This HP-IB test is an automated test; a Desktop Computer is required.**

**Two software listings are supplied. Table 4-30 gives a BASIC program listing for the HP 85F; Table 4-31 gives a BASIC program listing for the HP 9826A or HP 9836A, and 4-16. The test procedure applies to either test program used.**

**Description**

The test program given in Table 4-30 is written to verify the HP 8341A HP-IB interface by writing to and reading from the HP 8341A. The program also displays the HP 8341A status bytes similar to the format shown in Table 4-29, HP 8341A Status Byte Descriptions. Upon running the program the status bits displayed will change initially as the program outputs an IP (INSTR PRESET), S2 (Single sweep), and two TS (Take Sweep) commands. After about two passes through the output loop (program lines 120 to 300 for the HP 85F, program lines 130 to 350 for the HP 9826A/9836A), the status bits should all be zero's and the HP 8341A should be in LOCAL mode. The procedure instructs the operator to press specific HP 8341A front panel keys and perform certain functions which should set specific bits of the status bytes. This procedure will test most of the bits in the two status bytes. However, if the HP 8341A is working properly, the status bit for the Fault Indicator On, the Oven Cold, and the Self Test Failed will not be tested for the set state. By pressing a controller soft key, the program will test the data bits by outputting a series of binary numbers to the HP 8341A and reading back each number that it outputs. If a bit is held HIGH or LOW, the number read will not agree with the number written and the program will display an error message. This procedure does not test all of the HP-IB control lines.

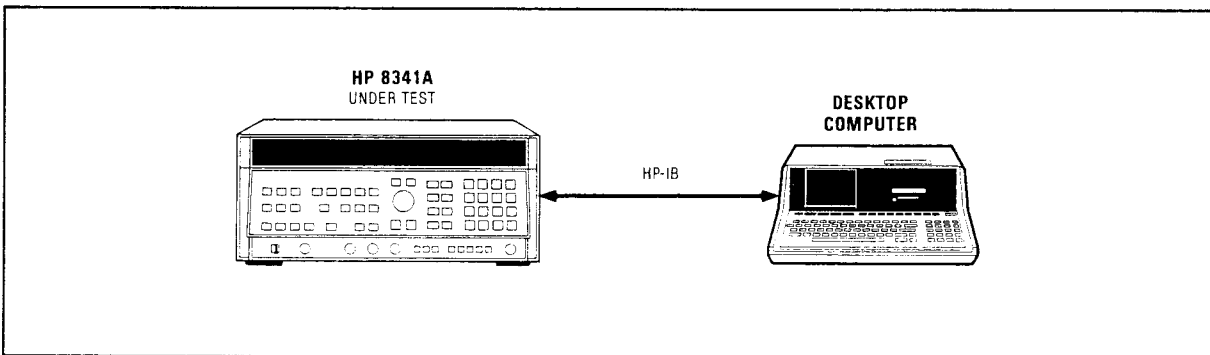

*Figure 4-20. HP 8341A HP-IB Operation and Verification Test Setup*

**Equipment**

- Desktop Computer..... HP 85F  
 (Includes HP 82937A HP-IB Interface and  
 I/O ROM HP P/N 00085-15002 and  
 HP 82936 ROM Drawer)
- Plotter/Printer ROM ..... HP P/N 00085-15002
- or
- Desktop Computer ..... HP 9826A/9836A  
 (With BASIC language and 512K byte memory)

**4-24. HP 8341A HP-IB OPERATION VERIFICATION TEST (Cont'd)****Procedure**

1. Connect the equipment as shown in Figure 4-20. Enter the program shown in Table 4-30 if the HP 85F is used, or the program in Table 4-31 if the HP 9826A or 9836A is used. Press the RUN key. The program will display the HP 8341A status bytes similar to Table 4-29. After the program goes through the output loop routine about two times, all status bits should be "0" and the HP 8341A should be in LOCAL mode (front panel REMOTE indicator not ON).
2. Press the HP 8341A **[INSTR PRESET]** key. After going through the output loop about three times, status byte 1 decimal value should be 24 (bits 4 and 3 set).

**NOTE**

**After pressing an HP 8341A front panel key, watch the displayed decimal value. When the decimal value changes, press the controller PAUSE key. Note the status bits that are set and press CONT.**

3. Press the HP 8341A **[CW]** key. After the program goes through the output loop about three times all status bits should be "0"; however, status byte 1, bit 1, should have been set during one of the output loop passes. Enter **[1] [5] [GHz]** and the byte 1 status bits will change, but after about 2 passes all status bits should be "0".
4. Press the **[POWER LEVEL]** key and increase the HP 8341A output power level using the rotary knob until the UNLEVELED light comes on. Status byte 2 decimal value should be 64 (bit 6 set). Decrease the output power level until the UNLEVELED light goes out. All status bits should be "0".
5. Switch the HP 8341A rear panel FREQUENCY REFERENCE switch to EXT. Status byte 2 value should be 24 (bits 4 and 3 set). Return the switch to INT.
6. Press the controller softkey K1 (SYNTAX).

**NOTE**

**There will be about a 6 second delay before the status bits change.**

The program will output the character string "XYZ" to the HP 8341A. The HP 8341A should not recognize this string and should set status byte 1, bit 5 (SRQ on HP-IB Syntax Error).

7. Press the controller softkey K4 (DATA BIT). The program will test all data bits and display an error message if any bits fail the test, or if all bits pass the test, the program will display "ALL DATA BITS WORKING".

## 4-24. HP 8341A HP-IB OPERATION VERIFICATION TEST (Cont'd)

Table 4-29. HP 8341A Status Byte Description

STATUS BYTE (#1)								
BIT #	7	6	5	4	3	2	1	0
DECIMAL VALUE	128	64	32	16	8	4	2	1
FUNCTION	SRQ on New frequencies or Sweep Time in Effect	REQUEST SERVICE (RQS)	SRQ on HP-IB Syntax Error	SRQ on End of Sweep	SRQ on RF Settled	SRQ on Changed in Extended Status Byte	SRQ on Numeric Entry Completed (HP-IB or Front Panel)	SRQ on Any Front Panel Key Pressed
EXTENDED STATUS BYTE (#2)								
BIT #	7	6	5	4	3	2	1	0
DECIMAL VALUE	128	64 (L)	32 (L)	16 (L)	8	4	2	1 (L)
FUNCTION	Fault Indicator On	RF Unleveled	Power Failure	RF Unlocked	External Freq. Ref. Selected	Oven Cold	Over Modulation	Self Test Failed
(L) See Note 3								

Table 4-30. HP 8341A HP-IB Operation Verification Programming Listing (For Use With HP 85F)

```

10      ! 8340A HP-IB OPERATION VERIFICATION
20      !   VERIFICATION TEST
30      !
40      !       14 SEPT 82
50      !
60      I1=719
70      OUTPUT I1 ;"IP S2 TSTS"
80      !
90      ON KEY# 1;"SYNTAX" GOSUB 370
100     ON KEY# 4;"DATA BIT" GOSUB 400
110     LOCAL 7
120     OUTPUT I1 ;"OS"
130     DISP "8340A STATUS BYTE 1 AND 2"
140     DISP
150     DISP "BYTE -----BIT-----"
160     DISP " # 7 6 5 4 3 2 1 0 VALUE"
170     DISP "-----"
180     DISP
190     ENTER I1 USING "#.B" ; E.F
200     FOR I=1 TO 2
210     DISP I:
220     IF I=1 THEN N=E
230     IF I=2 THEN N=F
240     FOR J=7 TO 0 STEP -1
250     A=BIT(N,J)
260     DISP A:
270     NEXT J
280     DISP N
290     DISP
300     NEXT I
310     DISP USING "4/.A" ; " "
320     KEY LABEL
330     GOTO 120
340     !
350     !   Syntax Test
360     !
370     OUTPUT I1 ; "XYZ"
380     RETURN
390     !
400     !   Test Data Bits
410     !
420     CLEAR
430     DSP USNG "/.K" ; "   TEST DATA BITS"
440     FOR C=0 TO 7
450     B=2 C
460     OUTPUT I1 USING "K.B" , "TI".B
470     WAIT 100
480     ENTER I1 USING "#.B" , D
490     IF B#D THEN DISP "   DATA BIT":I:"NOT WORKING"
500     NEXT C
510     DISP "ALL DATA BITS WORKING"
520     DISP "PRESS CONT"
530     PAUSE
540     RETURN
550     END

```

Table 4-31. HP 8341A HP-IB Operation Verification Programming Listing (For use with HP 9826A or 9836A)

```

10      ! 8340A HP-IB OPERATION
20      ! VERIFICATION TEST
30      !
40      !   7 APRIL 83
50      !
60      I1=719
70      OUTPUT I1:"IP S2 TSTS"
80      !
90      OFF KEY
100     ON KEY 1 LABEL "SYNTAX" GOTO Syntax
110     ON KEY 4 LABEL "DATA BIT" GOTO Data__bit
120     LOCAL 7
130     OUTPUT 1:CHRS(12);
140     !
150     Read__status: !
160     OUTPUT I1:"OS"
170     !
180     PRINT TABXY(1,1);"8340A STATUS BYTE 1 AND 2"
190     PRINT
200     PRINT "BYTE -----BIT-----"
210     PRINT " # 7 6 5 4 3 2 1 0  VALUE"
220     PRINT "-----"
230     PRINT
240     ENTER I1 USING "#.B":E.F
250     FOR I=1 TO 2
260         PRINT I;
270         IF I=1 THEN N=E
280         IF I=2 THEN N=F
290         FOR J=7 TO 0 STEP -1
300             A=BIT(N,J)
310             PRINT A;
320         NEXT J
330         PRINT USING "X.5D":N
340         PRINT
350     NEXT I
360     BEEP 200,.01
370     GOTO Read__status
380     !
390     Syntax: !
400     !
410     OUTPUT I1:"XYZ"
420     GOTO Read__status
430     !
440     Data__bit:!
450     !
460     OUTPUT 1:CHRS(12); ! Clear screen
470     DISP USING "%K%:" " TEST DATA BITS"
480     FOR C=0 TO 7
490         B=2 C
500         OUTPUT I1 USING "K.B":TT".B
510         WAIT .1
520         ENTER I1 USING "#.B":D
530         IF B-D<1 THEN GOTO 550
540         IF B<>D THEN DISP " DATA BIT ":I:" NOT WORKING"
550     NEXT C
560     !
570     PRINT "ALL DATA BITS WORKING"
580     DISP "PRESS CONTINUE"
590     PAUSE
600     DISP
610     GOTO Read__status
620     END

```



Table 4-32. HP 8341A Test Record Card (1 of 25)

<b>Hewlett-Packard 8341A Synthesized Sweeper</b>		<b>Date:</b> _____			
<b>Serial Number:</b> _____		<b>Tested By:</b> _____			
<b>Temperature:</b> _____ (as required)		<b>Humidity:</b> _____ (as required)			
SPECIFICATIONS TESTED Limits	Step	TEST Conditions	Lower Limit	Measured Value	Upper Limit
<b>4-9. Internal Time Base Aging Rate</b> T <sub>1</sub> = Time for 360 degree phase change T <sub>2</sub> = Time between T <sub>1</sub> and T <sub>3</sub> T <sub>3</sub> = Time for 360 degree phase change Calculated Aging Rate	3  4  5			_____ seconds  _____ hours  _____ seconds  _____ per day	

Table 4-32. HP 8341A Test Record Card (2 of 25)

SPECIFICATIONS TESTED Limits	Step	TEST Conditions	Lower Limit	Measured Value	Upper Limit
<b>4-10. Frequency Range and CW Mode Accuracy</b>					
Frequency Range Check					
10 MHz	2	Freq. $\pm 1$ Hz $\pm$ Counter Resolution		_____ MHz	
20 GHz	3	Freq. $\pm 3$ Hz $\pm$ Counter Resolution		_____ GHz	
M/N Divider Check (M Divider)	4b	Freq. $\pm 1$ Hz $\pm$ Counter Resolution			
M = 8 N = 13		2490 MHz		_____ MHz	
9		2480 MHz		_____ MHz	
10		2470 MHz		_____ MHz	
11		2460 MHz		_____ MHz	
12		2450 MHz		_____ MHz	
13		2440 MHz		_____ MHz	
14		2430 MHz		_____ MHz	
15		2420 MHz		_____ MHz	
16		2410 MHz		_____ MHz	
17		2400 MHz		_____ MHz	
18		2390 MHz		_____ MHz	
19		2380 MHz		_____ MHz	
20		2370 MHz		_____ MHz	
21		2360 MHz		_____ MHz	
22		2350 MHz		_____ MHz	
23		2340 MHz		_____ MHz	
24		2330 MHz		_____ MHz	
25		2320 MHz		_____ MHz	
26		2310 MHz		_____ MHz	
27		2300 MHz		_____ MHz	

Table 4-32. HP 8341A Test Record Card (3 of 25)

SPECIFICATIONS TESTED Limits	Step	TEST Conditions	Lower Limit	Measured Value	Upper Limit
4-10. Frequency Range and CW Mode Accuracy (cont'd)					
M/N Divider Check (N Divider)	56	Freq. $\pm 1$ Hz $\pm$ Counter Resolution			
M = 27 N = 13		2300 MHz		_____ MHz	
14		2500 MHz		_____ MHz	
15		2700 MHz		_____ MHz	
16		2900 MHz		_____ MHz	
17		3100 MHz		_____ MHz	
18		3300 MHz		_____ MHz	
19		3500 MHz		_____ MHz	
20		3700 MHz		_____ MHz	
21		3900 MHz		_____ MHz	
22		4100 MHz		_____ MHz	
23		4300 MHz		_____ MHz	
24		4500 MHz		_____ MHz	
25		4700 MHz		_____ MHz	
26		4900 MHz		_____ MHz	
27		5100 MHz		_____ MHz	
28		5300 MHz		_____ MHz	
29		5500 MHz		_____ MHz	
30		5700 MHz		_____ MHz	
31		5900 MHz		_____ MHz	
32		6100 MHz		_____ MHz	
33		6300 MHz		_____ MHz	
34		6500 MHz		_____ MHz	
35		6700 MHz		_____ MHz	
36		6900 MHz		_____ MHz	

Table 4-32. HP 8341A Test Record Card (4 of 25)

SPECIFICATIONS TESTED Limits	Step	TEST Conditions	Lower Limit	Measured Value	Upper Limit
4-10. Frequency Range and CW Mode Accuracy (cont'd)					
20-30 Loop Check (N2 Divider)					
HP 8341A ENTRY DISPLAY CF Frequency:		HP 8341A START Frequency Freq. $\pm 1$ Hz $\pm$ Counter Resolution			
2.310500 GHz	6b	2.310000 GHz		_____ GHz	
2.310501	6c	2.310001		_____ GHz	
2.310502		2.310002		_____ GHz	
2.310503		2.310003		_____ GHz	
2.310504		2.310004		_____ GHz	
2.310505		2.310005		_____ GHz	
2.310506		2.310006		_____ GHz	
2.310507		2.310007		_____ GHz	
2.310508		2.310008		_____ GHz	
2.310509		2.310009		_____ GHz	
2.310510		2.310010		_____ GHz	
2.310510	6d	2.310010		_____ GHz	
2.310520	6e	2.310020		_____ GHz	
2.310530		2.310030		_____ GHz	
2.310540		2.310040		_____ GHz	
2.310550		2.310050		_____ GHz	
2.310560		2.310060		_____ GHz	
2.310570		2.310070		_____ GHz	
2.310580		2.310080		_____ GHz	
2.310590		2.310090		_____ GHz	
2.310600		2.310100		_____ GHz	
2.310600	6f	2.310100		_____ GHz	
2.310700	6g	2.310200		_____ GHz	
2.310800		2.310300		_____ GHz	
2.310900		2.310400		_____ GHz	
2.311000		2.310500		_____ GHz	
2.311100		2.310600		_____ GHz	
2.311200		2.310700		_____ GHz	
2.311300		2.310800		_____ GHz	
2.311400		2.310900		_____ GHz	
2.311500		2.311000		_____ GHz	
2.311500	6h	2.311000		_____ GHz	
2.312500	6i	2.312000		_____ GHz	
2.313500		2.313000		_____ GHz	
2.314500		2.314000		_____ GHz	
2.315500		2.315000		_____ GHz	
2.316500		2.316000		_____ GHz	
2.317500		2.317000		_____ GHz	
2.318500		2.318000		_____ GHz	
2.319500		2.319000		_____ GHz	
2.320500		2.320000		_____ GHz	

Table 4-32. HP 8341A Test Record Card (5 of 25)

SPECIFICATIONS TESTED Limits	Step	TEST Conditions	Lower Limit	Measured Value	Upper Limit
<b>4-10. Frequency Range and CW Mode Accuracy (cont'd)</b>					
20-30 Loop Check (N1 Divider)					
HP 8341A ENTRY DISPLAY	7a	Frequency Counter Indicator			
CW Frequency:	7c	Freq. $\pm 1 \text{ Hz} \pm \text{Counter Resolution}$		_____ MHz	
2319.97 MHz	7d			_____ MHz	
2319.96	7e			_____ MHz	
2319.95				_____ MHz	
2319.94				_____ MHz	
2319.93				_____ MHz	
2319.92				_____ GHz	
2319.91				_____ MHz	
2319.90				_____ MHz	
2319.89				_____ MHz	
2319.88				_____ MHz	
2319.87				_____ MHz	
2319.87				_____ MHz	
2319.77				_____ MHz	
2319.67				_____ MHz	
2319.57				_____ MHz	
2319.47				_____ MHz	
2319.37				_____ MHz	
2319.27				_____ MHz	
2319.17				_____ MHz	
2319.07				_____ MHz	
2318.97	7f			_____ MHz	
2318.97	7g			_____ MHz	
2317.97				_____ MHz	
2316.97				_____ MHz	
2315.97				_____ MHz	
2314.97				_____ MHz	
2313.97				_____ MHz	
2312.97				_____ MHz	
2311.97				_____ MHz	
2310.97				_____ MHz	

Table 4-32. HP 8341A Test Record Card (6 of 25)

SPECIFICATIONS TESTED Limits	Step	TEST Conditions	Lower Limit	Measured Value	Upper Limit
<b>4-11. Sweep Time Accuracy</b>  10 milliseconds 100 milliseconds 1 second 10 seconds 50 seconds	4		9.5 msec 9.5 msec 0.95 sec 9.5 sec 47.5 sec	_____ msec _____ msec _____ sec _____ sec _____ sec	10.5 msec 105 msec 1.05 sec 10.5 sec 52.5 sec

Table 4-32. HP 8341A Test Record Card (7 of 25)

SPECIFICATIONS TESTED Limits		Step	TEST Conditions		Lower Limit	Measured Value	Upper Limit
4-12. Swept Frequency Accuracy		8					
20% of Band Accuracy							
HP 8341A Start Freq. (GHz)	HP 8341A Stop Freq. (GHz)		20% of Band	Test Limit (KHz)	Spectrum Analyzer Center Freq. (GHz)	Spectrum Analyzer Center Freq. (GHz)	Spectrum Analyzer Center Freq. (GHz)
2.3	2.300099		2.3000198	±0.99	2.30001881	_____	2.30002079
2.3	2.300101		2.3000202	±1.01	2.30001919	_____	2.30002121
2.3	2.300499		2.3000998	±4.99	2.30009481	_____	2.30010479
2.3	2.300501		2.3001002	±5.01	2.30009519	_____	2.30010521
2.3	2.30499		2.300998	±49.9	2.3009481	_____	2.3010479
2.3	2.30501		2.301002	±100.02	2.30090198	_____	2.30110202
2.3	2.31		2.302	±200	2.3018	_____	2.3022
2.3	2.32		2.304	±400	2.3036	_____	2.3044
2.3	2.33		2.306	±600	2.3054	_____	2.3066
2.3	2.34		2.308	±800	2.3072	_____	2.3088
2.3	2.349		2.3098	±998	2.308802	_____	2.310798
2.3	2.3501		2.31002	±1020	2.309	_____	2.31104
2.3	2.36		2.312	±1200	2.3108	_____	2.3132
2.3	2.37		2.314	±1400	2.3126	_____	2.3154
2.3	2.38		2.316	±1600	2.3144	_____	2.3176
2.3	2.39		2.318	±1800	2.3162	_____	2.3198
2.3	2.3999		2.31998	±1980	2.318	_____	2.32196
2.3	2.4001		2.32002	±1001	2.319019	_____	2.31021
2.3	2.799		2.3998	±4990	2.39481	_____	2.40479
2.3	2.801		2.4002	±5010	2.39519	_____	2.40521
2.3	7.29		3.298	±49900	3.2481	_____	3.3479
2.3	7.31		3.302	±50000	3.252	_____	3.352
2.3	8.3		3.500	±50000	3.45	_____	3.55
2.3	16.452		5.1304	±50000	5.0804	_____	5.1804
2.3	20.0		5.84	±50000	5.79	_____	5.89

Table 4-32. HP 8341A Test Record Card (8 of 25)

SPECIFICATIONS TESTED Limits		Step	TEST Conditions		Lower Limit	Measured Value	Upper Limit
4-12. Swept Frequency Accuracy (cont'd)		8					
50% of Band Accuracy							
HP 8341A Start Freq. (GHz)	HP 8341A Stop Freq. (GHz)		50% Band	Test Limit (KHz)	Spectrum Analyzer Center Freq. (GHz)	Spectrum Analyzer Center Freq. (GHz)	Spectrum Analyzer Center Freq. (GHz)
2.3	2.300099		2.3000495	±0.99	2.30004851	_____	2.30005049
2.3	2.300101		2.3000505	±1.01	2.30004949	_____	2.30005151
2.3	2.300499		2.3002495	±4.99	2.30024451	_____	2.30025449
2.3	2.300501		2.3002505	±5.01	2.30024549	_____	2.30025551
2.3	2.30499		2.302495	±49.9	2.3024451	_____	2.3025449
2.3	2.30501		2.302505	±100.02	2.30240498	_____	2.30260502
2.3	2.31		2.305	±200	2.3048	_____	2.3052
2.3	2.32		2.310	±400	2.3096	_____	2.3104
2.3	2.33		2.315	±600	2.3144	_____	2.3156
2.3	2.34		2.320	±800	2.3192	_____	2.3208
2.3	2.349		2.3245	±998	2.323502	_____	2.325498
2.3	2.3501		2.32505	±1020	2.32403	_____	2.32607
2.3	2.36		2.33	±1200	2.3288	_____	2.3312
2.3	2.37		2.335	±1400	2.3336	_____	2.3364
2.3	2.38		2.34	±1600	2.3384	_____	2.3416
2.3	2.39		2.345	±1800	2.3432	_____	2.3468
2.3	2.3999		2.34995	±1980	2.34797	_____	2.35193
2.3	2.4001		2.35005	±1001	2.349049	_____	2.351051
2.3	2.799		2.5495	±4990	2.54451	_____	2.55449
2.3	2.801		2.5505	±5010	2.54549	_____	2.55551
2.3	7.29		4.795	±49900	4.7451	_____	4.8449
2.3	7.31		4.805	±50000	4.755	_____	4.855
2.3	8.3		5.300	±50000	5.250	_____	5.350
2.3	16.452		9.376	±50000	9.326	_____	9.426
2.3	20.0		11.15	±50000	11.10	_____	11.202



Table 4-32. HP 8341A Test Record Card (9 of 25)

SPECIFICATIONS TESTED Limits		Step	TEST Conditions		Lower Limit	Measured Value	Upper Limit
4-12. Swept Frequency Accuracy (cont'd)		8					
80% of Band Accuracy							
HP 8341A Start Freq. (GHz)	HP 8341A Stop Freq. (GHz)		80% of Band	Test Limit (KHz)	Spectrum Analyzer Center Freq. (GHz)	Spectrum Analyzer Center Freq. (GHz)	Spectrum Analyzer Center Freq. (GHz)
2.3	2.300099		2.3000792	±0.99	2.30007821	_____	2.30008019
2.3	2.300101		2.3000808	±1.01	2.30007979	_____	2.30008181
2.3	2.300499		2.3003992	±4.99	2.30039421	_____	2.30040419
2.3	2.300501		2.3004008	±5.01	2.30039579	_____	2.30040581
2.3	2.30499		2.303992	±49.9	2.3039421	_____	2.3040419
2.3	2.30501		2.304008	±100.02	2.30390798	_____	2.30410802
2.3	2.31		2.308	±200	2.3078	_____	2.3082
2.3	2.32		2.316	±400	2.3156	_____	2.3164
2.3	2.33		2.324	±600	2.3234	_____	2.3246
2.3	2.34		2.332	±800	2.3312	_____	2.3328
2.3	2.349		2.3392	±998	2.338202	_____	2.340198
2.3	2.3501		2.34008	±1020	2.33906	_____	2.3411
2.3	2.36		2.348	±1200	2.3468	_____	2.3492
2.3	2.37		2.356	±1400	2.3546	_____	2.3574
2.3	2.38		2.364	±1600	2.3624	_____	2.3656
2.3	2.39		2.372	±1800	2.3702	_____	2.3738
2.3	2.3999		2.3792	±1980	2.37794	_____	2.3738
2.3	2.4001		2.38008	±1001	2.379079	_____	2.3819
2.3	2.799		2.6992	±4990	2.69421	_____	2.381081
2.3	2.801		2.7008	±5010	2.69579	_____	2.70419
2.3	7.29		6.292	±49900	6.2421	_____	2.70581
2.3	7.31		6.308	±50000	6.258	_____	6.3419
2.3	8.3		7.1	±50000	7.05	_____	6.358
2.3	16.452		13.6216	±50000	13.5716	_____	7.15
2.3	20.0		16.46	±50000	16.41	_____	13.6716
						_____	16.51

Table 4-32. HP 8341A Test Record Card (10 of 25)

SPECIFICATIONS TESTED Limits	Step	TEST Conditions	Lower Limit	Measured Value	Upper Limit
<b>4-13. Maximum Leveled Output Power and Power Accuracy</b>					
Maximum Leveled Power Band 0 ENTRY DISPLAY Power Indication	3	Continuous Sweep. Auto Sweep Time		_____ dBm	
	4	Single Sweep. Auto Sweep Time		_____ dBm	
	5	Single Sweep. 2 Second Sweep Time		_____ dBm	
Lowest power level recorded in step 3, 4, or 5	6			_____ dBm	
Minimum Power Frequency		M2 Frequency		_____ GHz	
Power Meter Indication	7	Standard Instrument (F.P. Out No Atten.)	+10 dBm	_____ dBm	
		Option 001 (F.P. Out With Atten.)	+10 dBm (+10 dBm) <sup>1</sup>	_____ dBm	
		Option 002 (High Power. 2.3 to 18.6 GHz)	+10 dBm	_____ dBm	
		Option 004 (R.P. Out With Atten.)	+10 dBm (+10 dBm) <sup>1</sup>	_____ dBm	
		Option 005 (R.P. Out No Atten.)	+10 dBm (+10 dBm) <sup>1</sup>	_____ dBm	
Maximum Leveled Power Band 1 ENTRY DISPLAY Power Indication	3	Continuous Sweep. Auto Sweep Time		_____ dBm	
	4	Single Sweep. auto Sweep Time		_____ dBm	
	5	Single Sweep. 2 Second Sweep Time		_____ dBm	
Lowest power level recorded in step 3, 4, or 5	6			_____ dBm	
Minimum Power Frequency		M2 Frequency		_____ GHz	
Power Meter Indication	7	Standard Instrument (F.P. Out No Atten.)	+10 dBm	_____ dBm	
		Option 001 (F.P. Out With Atten.)	+9 dBm (+12 dBm) <sup>1</sup>	_____ dBm	
		Option 002 (High Power. 2.3 to 18.6 GHz)	+13 dBm	_____ dBm	
		Option 004 (R.P. Out with atten.)	+9 dBm (+11 dBm) <sup>1</sup>	_____ dBm	
		Option 005 (R.P. Out No Atten.)	+10 dBm (+12 dBm) <sup>1</sup>	_____ dBm	

<sup>1</sup>With Option 002, High Power. 2.3 to 18.6 GHz.

Table 4-32. HP 8341A Test Record Card (11 of 25)

SPECIFICATIONS TESTED Limits	Step	TEST Conditions	Lower Limit	Measured Value	Upper Limit
<b>4-13. Maximum Leveled Output Power and Power Accuracy (cont'd)</b>					
Maximum Leveled Power Band 2					
ENTRY DISPLAY Power Indication	3	Continuous Sweep. Auto Sweep Time		_____ dBm	
	4	Single Sweep. Auto Sweep Time		_____ dBm	
	5	Single Sweep. 2 Second Sweep Time		_____ dBm	
Lowest power level recorded in step 3, 4, or 5	6			_____ dBm	
Minimum Power Frequency		M2 Frequency		_____ GHz	
Power Meter Indication	7	Standard Instrument (F.P. Out No Atten.)	+10 dBm	_____ dBm	
		Option 001 (F.P. Out With Atten.)	+8 dBm (+11 dBm) <sup>1</sup>	_____ dBm	
		Option 002 (High Power, 2.3 to 18.6 GHz)	+13 dBm	_____ dBm	
		Option 004 (R.P. Out With Atten.)	+8 dBm (+10 dBm) <sup>1</sup>	_____ dBm	
		Option 005 (R.P. Out No Atten.)	+10 dBm (+12 dBm) <sup>1</sup>	_____ dBm	
Maximum Leveled Power Band 3 (13.5-18.6 GHz)					
ENTRY DISPLAY Power Indication	3	Continuous Sweep. Auto Sweep Time		_____ dBm	
	4	Single Sweep. Auto Sweep Time		_____ dBm	
	5	Single Sweep. 2 Second Sweep Time		_____ dBm	
Lowest Power Level recorded in step 3, 4, or 5	6			_____ dBm	
Minimum Power Frequency		M2 Frequency		_____ GHz	
Power Meter Indication	7	Standard Instrument (F.P. Out No Atten.)	+10 dBm	_____ dBm	
		Option 001 (F.P. Out With Atten.)	+8 dBm (+11 dBm) <sup>1</sup>	_____ dBm	
		Option 002 (High Power, 2.3 to 18.6 GHz)	+13 dBm	_____ dBm	
		Option 004 (R.P. Out With Atten.)	+7 dBm (+10 dBm) <sup>1</sup>	_____ dBm	
		Option 005 (R.P. Out No Atten.)	+9 dBm (+12 dBm) <sup>1</sup>	_____ dBm	

<sup>1</sup> With Option 002, High Power, 2.3 to 18.6 GHz.

Table 4-32. HP 8341A Test Record Card (12 of 25)

SPECIFICATIONS TESTED Limits	Step	TEST Conditions	Lower Limit	Measured Value	Upper Limit
<b>4-13 Maximum Leveled Output Power and Power Accuracy (cont'd)</b>  Maximum Leveled Power Band 3 (18.6-20.0 GHz) ENTRY DISPLAY Power Indication  Lowest power level recorded in step 3, 4, or 5  Minimum Power Frequency  Power Meter Indication	3	Continuous Sweep, Auto Sweep Time		_____ dBm	
	4	Single Sweep, Auto Sweep Time		_____ dBm	
	5	Single Sweep, 2 Second Sweep Time		_____ dBm	
	6				
	7	M2 Frequency		_____ GHz	
		Standard Instrument (F.P. Out No Atten.)	+10 dBm	_____ dBm	
		Option 001 (F.P. Out With Atten.)	+8 dBm (+8 dBm) <sup>1</sup>	_____ dBm	
		Option 002 (High Power, 2.3 to 18.6 GHz)	+10 dBm	_____ dBm	
		Option 004 (R.P. Out With Atten.)	+7 dBm (+7 dBm) <sup>1</sup>	_____ dBm	
		Option 005 (R.P. Out No Atten.)	+9 dBm (+9 dBm) <sup>1</sup>	_____ dBm	

<sup>1</sup>With Option 002, High Power, 2.3 to 18.6 GHz.

Table 4-32. HP 8341A Test Record Card (13 of 25)

SPECIFICATIONS TESTED Limits	Step	TEST Conditions	Lower Limit	Measured Value	Upper Limit
<b>4-13. Maximum Leveled Output Power and Power Accuracy (cont'd)</b>					
Flatness	0				
Band 0 Measurement					
Minimum Power Frequency	13	M2 Frequency		_____ GHz	
Minimum Power Level	14	M2 Power Level		_____ dBm	
Maximum Power Frequency	15	M1 Frequency		_____ GHz	
Maximum Power Level		M1 Power Level		_____ dBm	
Band 1 Measurement					
Minimum Power Frequency	13	M2 Frequency		_____ GHz	
Minimum Power Level	14	M2 Power Level		_____ dBm	
Maximum Power Frequency	15	M1 Frequency		_____ GHz	
Maximum Power Level		M1 Power Level		_____ dBm	
Band 2 Measurement					
Minimum Power Frequency	13	M2 Frequency		_____ GHz	
Minimum Power Level	14	M2 Power Level		_____ dBm	
Maximum Power Frequency	15	M1 Frequency		_____ GHz	
Maximum Power Level		M1 Power Level		_____ dBm	
Band 3 Measurement					
Minimum Power Frequency	13	M2 Frequency		_____ GHz	
Minimum Power Level	14	M2 Power Level		_____ dBm	
Maximum Power Frequency	15	M1 Frequency		_____ GHz	
Maximum Power Level		M1 Power Level		_____ dBm	

Table 4-32. HP 8341A Test Record Card (14 of 25)

SPECIFICATIONS TESTED Limits	Step	TEST Conditions	Lower Limit	Measured Value	Upper Limit
<p><b>4-13. Maximum Leveled Output Power and Power Accuracy (cont'd)</b></p> <p>Flatness (Maximum minum Minimum Calculations)</p> <p>Band 0 Calculation</p> <p>Band 1 Calculation</p> <p>Band 2 Calculation</p> <p>Band 3 Calculation</p>	<p>18</p>	<p>≤1.2 dB (Standard)                      ≤1.4 dB (Option 004)                      ≤1.2 dB (Option 001)                      ≤1.4 dB (Option 005)</p> <p>≤1.8 dB (Standard)                      ≤2.6 dB (Option 004)                      ≤2.2 dB (Option 001)                      ≤2.2 dB (Option 005)</p> <p>≤1.8 dB (Standard)                      ≤2.6 dB (Option 004)                      ≤2.2 dB (Option 001)                      ≤2.2 dB (Option 005)</p> <p>≤1.8 dB (Standard)                      ≤2.6 dB (Option 004)                      ≤2.2 dB (Option 001)                      ≤2.2 dB (Option 005)</p>		<p>_____ dB</p> <p>_____ dB</p> <p>_____ dB</p> <p>_____ dB</p>	

Table 4-32. HP 8341A Test Record Card (15 of 25)

SPECIFICATIONS TESTED Limits	Step	TEST Conditions	Lower Limit	Measured Value	Upper Limit
<b>4-14. External Leveling</b>  Leveling Voltage (dBv) +6 0 -10 -20  -30 -40  -50 -60 -66	3	(Using Positive Crystal Detector)	1.883 V 0.944 V 0.2983 V 0.0942 V  29.65 mV 9.24 mV  2.785 mV 0.744 mV 0.273 mV	_____ V _____ V _____ V _____ V  _____ mV _____ mV  _____ mV _____ mV _____ mV	2.114 V 1.059 V 0.3352 V 0.1061 V  33.70 mV 10.79 mV  3.550 mV 1.259 mV 0.731 mV

Table 4-32. HP 8341A Test Record Card (16 of 25)

SPECIFICATIONS TESTED Limits	Step	TEST Conditions	Lower Limit	Measured Value	Upper Limit
<p>4-15. Spurious Signals (10 MHz to 20 GHz)</p> <p>Frequency of Interest Selected</p>	<p>4</p> <p>6</p>	<p>Refer to Table 4-15 for Specifications</p>			



Table 4-32. HP 8341A Test Record Card (17 of 25)

SPECIFICATIONS TESTED Limits	Step	TEST Conditions	Lower Limit	Measured Value	Upper Limit			
					Standard	Option 007		
<b>4-17. Single Sideband Phase Noise Calculated Phase Noise from Steps 11 through 38 (Using Tables 4-18, 4-19, and 4-21)</b>  2.202 GHz Offset = 30 Hz 100 Hz 1 kHz 10 kHz 100 kHz  6.902 GHz Offset = 30 Hz 100 Hz 1 kHz 10 kHz 100 kHz  13.402 GHz Offset = 30 Hz 100 Hz 1 kHz 10 kHz 100 kHz  19.502 GHz Offset = 30 Hz 100 Hz 1 kHz 10 kHz 100 kHz	38							
						_____ dBc	-	<- 64 dBc
						_____ dBc	<- 67 dBc	<- 70 dBc
						_____ dBc	<- 75 dBc	<- 78 dBc
						_____ dBc	<- 83 dBc	<- 86 dBc
						_____ dBc	<- 107 dBc	<- 107 dBc
						_____ dBc	-	<- 64 dBc
						_____ dBc	<- 67 dBc	<- 70 dBc
						_____ dBc	<- 75 dBc	<- 78 dBc
						_____ dBc	<- 83 dBc	<- 86 dBc
						_____ dBc	<- 107 dBc	<- 107 dBc
						_____ dBc	-	<- 58 dBc
						_____ dBc	<- 61 dBc	<- 64 dBc
						_____ dBc	<- 69 dBc	<- 72 dBc
						_____ dBc	<- 77 dBc	<- 80 dBc
						_____ dBc	<- 101 dBc	<- 101 dBc
						_____ dBc	-	<- 54 dBc
						_____ dBc	<- 57 dBc	<- 60 dBc
						_____ dBc	<- 65 dBc	<- 68 dBc
						_____ dBc	<- 73 dBc	<- 76 dBc
				_____ dBc	<- 97 dBc	<- 97 dBc		

Table 4-32. HP 8341A Test Record Card (18 of 25)

SPECIFICATIONS TESTED Limits	Step	TEST Conditions	Lower Limit	Measured Value	Upper Limit
<b>4-18. Power Sweep</b>					
1 GHz					
Start Level	5			_____ dBm	
End Level	6			_____ dBm	
Power Sweep Range	7	Must be $\geq 20$ dB difference	20 dB	_____ dB	
5 GHz					
Start Level	5			_____ dBm	
End Level	6			_____ dBm	
Power Sweep Range	7	Must be $\geq 20$ dB difference	20 dB	_____ dB	
10 GHz					
Start Level	5			_____ dBm	
End Level	6			_____ dBm	
Power Sweep Range	7	Must be $\geq 20$ dB difference	20 dB	_____ dB	
15 GHz					
Start Level	5			_____ dBm	
End Level	6			_____ dBm	
Power Sweep Range	7	Must be $\geq 20$ dB difference	20 dB	_____ dB	

Table 4-32. HP 8341A Test Record Card (19 of 25)

SPECIFICATIONS TESTED Limits	Step	TEST Conditions	Lower Limit	Measured Value	Upper Limit
<b>4-19. Pulse Modulation ON/OFF Ratio (Applies only to instruments with Option 006, Pulse Modulation)</b>  1 GHz 3 GHz 9 GHz 15 GHz	4	$\Delta$ Amplitude must be >80 dB	80 dB 80 dB 80 dB 80 dB	____ dB ____ dB ____ dB ____ dB	
<b>4-20. Pulse Modulation Rise and Fall Time</b>  1 GHz Rise Time Fall Time  3 GHz Rise Time Fall Time  9 GHz Rise Time Fall Time  15 GHz Rise Time Fall Time	6 8  6 8  6 8  6 8	Rise Times: 90% point should be <25 nanoseconds from 10% point   Fall Times: 10% point should be <25 nanoseconds from 90% point		____ nsec ____ nsec  ____ nsec ____ nsec  ____ nsec ____ nsec  ____ nsec ____ nsec	25 nsec 25 nsec  25 nsec 25 nsec  25 nsec 25 nsec

Table 4-32. HP 8341A Test Record Card (20 of 25)

SPECIFICATIONS TESTED Limits	Step	TEST Conditions	Lower Limit	Measured Value	Upper Limit
<b>4-21. Pulse Modulation Accuracy (Applies only to instruments equipped with Option 006, Pulse Modulation)</b>					
HP 8341A CW Freq. = 1 GHz PRF = 100 kHz					
Pulse Width = 100 nsec	6	ENTRY DISPLAY Power Level		_____ dBm	
	7	ENTRY DISPLAY Power Level		_____ dBm	
	8	Δ Power between steps 6 and 7	> -0.3 dB	_____ dB	< +3 dB
Pulse Width = 200 nsec	6	ENTRY DISPLAY Power Level		_____ dBm	
	7	ENTRY DISPLAY Power Level		_____ dBm	
	8	Δ Power between steps 6 and 7	> -0.3 dB	_____ dB	< +1.5 dB
Pulse Width = 500 nsec	6	ENTRY DISPLAY Power Level		_____ dBm	
	7	ENTRY DISPLAY Power Level		_____ dBm	
	8	Δ Power between steps 6 and 7	> -0.3 dB	_____ dB	< +0.3 dB
Pulse Width = 1000 nsec	6	ENTRY DISPLAY Power Level		_____ dBm	
	7	ENTRY DISPLAY Power Level		_____ dBm	
	8	Δ Power between steps 6 and 7	> -0.3 dB	_____ dB	< +0.3 dB
Pulse Repetition Freq. Range HP 8341A CW Freq. = 1 GHz	10				
Minimum PRF PRF = 100 Hz PW = 1 microsecond	6	ENTRY DISPLAY Power Level		_____ dBm	
	7	ENTRY DISPLAY Power Level		_____ dBm	
	8	Δ Power between steps 6 and 7	> -0.3 dB	_____ dB	< +0.3 dB
Maximum PRF PRF = 5 MHz PW = 100 nanoseconds	6	ENTRY DISPLAY Power Level		_____ dBm	
	7	ENTRY DISPLAY Power Level		_____ dBm	
	8	Δ Power between steps 6 and 7	> -0.3 dB	_____ dB	< +3 dB
HP 8341A CW Freq. = 3 GHz PRF = 100 kHz					
Pulse Width = 100 nsec	6	ENTRY DISPLAY Power Level		_____ dBm	
	7	ENTRY DISPLAY Power Level		_____ dBm	
	8	Δ Power between steps 6 and 7	> -0.3 dB	_____ dB	< +1.5 dB
Pulse Width = 200 nsec	6	ENTRY DISPLAY Power Level		_____ dBm	
	7	ENTRY DISPLAY Power Level		_____ dBm	
	8	Δ Power between steps 6 and 7	> -0.3 dB	_____ dB	< +0.3 dB
Pulse Width = 500 nsec	6	ENTRY DISPLAY Power Level		_____ dBm	
	7	ENTRY DISPLAY Power Level		_____ dBm	
	8	Δ Power between steps 6 and 7	> -0.3 dB	_____ dB	< +0.3 dB
Pulse Width = 1000 nsec	6	ENTRY DISPLAY Power Level		_____ dBm	
	7	ENTRY DISPLAY Power Level		_____ dBm	
	8	Δ Power between steps 6 and 7	> -0.3 dB	_____ dB	< +0.3 dB

Table 4-32. HP 8341A Test Record Card (21 of 25)

SPECIFICATIONS TESTED Limits	Step	TEST Conditions	Lower Limit	Measured Value	Upper Limit
<b>4-21. Pulse Modulation Accuracy (Applied only to instruments equipped with Option 006, Pulse Modulation), (cont'd)</b>					
Pulse Repetition Freq. Range HP 8341A CW Freq. = 3 GHz	10				
Minimum PRF PRF = 100 Hz PW = 1 microsecond	6	ENTRY DISPLAY Power Level		_____ dBm	
	7	ENTRY DISPLAY Power Level		_____ dBm	
	8	Δ Power between steps 6 and 7	>- 0.3 dB	_____ dB	<+0.3 dB
Maximum PRF PRF = 5 MHz PW = 100 nanoseconds	6	ENTRY DISPLAY Power Level		_____ dBm	
	7	ENTRY DISPLAY Power Level		_____ dBm	
	8	Δ Power between steps 6 and 7	>-0.3 dB	_____ dB	<+1.5 dB
HP 8341A CW Freq. = 9 GHz PRF = 100 kHz					
Pulse Width = 100 nsec	6	ENTRY DISPLAY Power Level		_____ dBm	
	7	ENTRY DISPLAY Power Level		_____ dBm	
	8	Δ Power between steps 6 and 7	>-0.3dB	_____ dB	<+1.5 dB
Pulse Width = 200 nsec	6	ENTRY DISPLAY Power Level		_____ dBm	
	7	ENTRY DISPLAY Power Level		_____ dBm	
	8	Δ Power between steps 6 and 7	>-0.3 dB	_____ dB	<+0.3 dB
Pulse Width = 500 nsec	6	ENTRY DISPLAY Power Level		_____ dBm	
	7	ENTRY DISPLAY Power Level		_____ dBm	
	8	Δ Power between steps 6 and 7	>-0.3 dB	_____ dB	<+0.3 dB
Pulse Width = 1000 nsec	6	ENTRY DISPLAY Power Level		_____ dBm	
	7	ENTRY DISPLAY Power Level		_____ dBm	
	8	Δ Power between steps 6 and 7	>-0.3 dB	_____ dB	<+0.3 dB
Pulse Repetition Freq. Range HP 8341A CW Freq. = 9 GHz	10				
Minimum PRF PRF = 100 Hz PW = 1 microsecond	6	ENTRY DISPLAY Power Level		_____ dBm	
	7	ENTRY DISPLAY Power Level		_____ dBm	
	8	Δ Power between steps 6 and 7	>-0.3 dB	_____ dB	<+0.3 dB
Maximum PRF PRF = 5 MHz PW = 100 nanoseconds	6	ENTRY DISPLAY Power Level		_____ dBm	
	7	ENTRY DISPLAY Power Level		_____ dBm	
	8	Δ Power between steps 6 and 7	>-0.3 dB	_____ dB	<+1.5 dB

Table 4-32. HP 8341A Test Record Card (22 of 25)

SPECIFICATIONS TESTED Limits	Step	TEST Conditions	Lower Limit	Measured Value	Upper Limit
<b>4-21. Pulse Modulation Accuracy</b> (Applies only to instruments equipped with Option 006, Pulse Modulation), (cont'd)					
HP 8341A CW Freq. = 15 GHz PRF = 100 kHz					
Pulse Width = 100 nsec	6	ENTRY DISPLAY Power Level		_____ dBm	
	7	ENTRY DISPLAY Power Level		_____ dBm	
	8	Δ Power between steps 6 and 7	> -0.3 dB	_____ dB	< +1.5 dB
Pulse Width = 200 nsec	6	ENTRY DISPLAY Power Level		_____ dBm	
	7	ENTRY DISPLAY Power Level		_____ dBm	
	8	Δ Power between steps 6 and 7	> -0.3 dB	_____ dB	< +0.3 dB
Pulse Width = 500 nsec	6	ENTRY DISPLAY Power Level		_____ dBm	
	7	ENTRY DISPLAY Power Level		_____ dBm	
	8	Δ Power between steps 6 and 7	> -0.3 dB	_____ dB	< +0.3 dB
Pulse Width = 1000 nsec	6	ENTRY DISPLAY Power Level		_____ dBm	
	7	ENTRY DISPLAY Power Level		_____ dBm	
	8	Δ Power between steps 6 and 7	> -0.3 dB	_____ dB	< +0.3 dB
Pulse Repetition Freq. Range HP 8341A CW Freq. = 15 GHz	10				
Minimum PRF PRF = 100 Hz PW = 1 microsecond	6	ENTRY DISPLAY Power Level		_____ dBm	
	7	ENTRY DISPLAY Power Level		_____ dBm	
	8	Δ Power between steps 6 and 7	> -0.3 dB	_____ dB	< +0.3 dB
Maximum PRF PRF = 5 MHz PW = 100 nanoseconds	6	ENTRY DISPLAY Power Level		_____ dBm	
	7	ENTRY DISPLAY Power Level		_____ dBm	
	8	Δ Power between steps 6 and 7	> -0.3 dB	_____ dB	< +1.5 dB

Table 4-32. HP 8341A Test Record Card (23 of 25)

SPECIFICATIONS TESTED Limits	Step	TEST Conditions	Lower Limit	Measured Value	Upper Limit
<b>4-22. Pulse Modulation Video Feedthrough</b>					
HP 8341A CW Freq. = 0.5 GHz Power Level = +8 dBm 0 dBm -10 dBm	7	Oscilloscope peak-to-peak voltage		_____ mV	<12 mV
			_____ mV	<5 mV	
			_____ mV	<1.6 mV	
HP 8341A CW Freq. = 1 GHz Power Level = +8 dBm 0 dBm -10 dBm	7			_____ mV	<12 mV
				_____ mV	<5 mV
			_____ mV	<1.6 mV	
HP 8341A CW Freq. = 1.5 GHz Power Level = +8 dBm 0 dBm -10 dBm	7			_____ mV	<12 mV
				_____ mV	<5 mV
				_____ mV	<1.6 mV
HP 8341A CW Freq. = 2 GHz Power Level = +8 dBm 0 dBm -10 dBm	7 10			_____ mV	<12 mV
				_____ mV	<5 mV
				_____ mV	<1.6 mV
HP 8341A CW Freq. = >2.3 GHz Power Level = -10 dBm (Any Frequency Selected)	10			_____ mV	<0.2 mV

Table 4-32. HP 8341A Test Record Card (24 of 25)

SPECIFICATIONS TESTED Limits	Step	TEST Conditions	Lower Limit	Measured Value	Upper Limit
<b>4-23. Amplitude Modulation</b>					
AM Sensitivity					
HP 8341A Freq. = 1.5 GHz Power = -5 dBm	2				
+30% Modulation	4	Power Meter Indication		_____ dB	
-30% Modulation	5	Power Meter Change	>2.18 dB	_____ dB	<2.38 dB
	6	Power Meter Change	>2.91 dB	_____ dB	<3.29 dB
HP 8341A Freq. = 1.5 GHz Power = +5 dBm	7				
+30% Modulation	4	Power Meter Indication		_____ dB	
-30% Modulation	5	Power Meter Change	>2.18 dB	_____ dB	<2.38 dB
	6	Power Meter Change	>2.91 dB	_____ dB	<3.29 dB
HP 8341A Freq. = 4.5 GHz Power = -5 dBm	8				
+30% Modulation	4	Power Meter Indication		_____ dB	
-30% Modulation	5	Power Meter Change	>2.18 dB	_____ dB	<2.38 dB
	6	Power Meter Change	>2.91 dB	_____ dB	<3.29 dB
HP 8341A Freq. = 4.5 GHz Power = +5 dBm	8				
+30% Modulation	4	Power Meter Indication	>2.18 dB	_____ dB	
-30% Modulation	5	Power Meter Change	>2.91 dB	_____ dB	<2.38 dB
	6	Power Meter Change		_____ dB	<3.29 dB
HP 8341A Freq. = 1.5 GHz					
AM Frequency Response	11	Note DVM Indication		_____ Vrms	
Funct. Gen. = 1 kHz	12	Flatness (read on Modulation Analyzer)		_____ dB	≤±0.2 dB
100 Hz	13			_____ dB	≤±0.2 dB
200 Hz				_____ dB	≤±0.2 dB
500 Hz				_____ dB	≤±0.2 dB
2 kHz				_____ dB	≤±0.2 dB
5 kHz				_____ dB	≤±0.2 dB
10 kHz				_____ dB	≤±0.2 dB
AM Bandwidth	14	Modulation Analyzer Indication	≥-3 dB	_____ dB	
Funct. Gen. = 100 kHz					
Adjust output level to that noted in Step 11					
AM Depth	15	Maximum Modulation Depth	>90%	_____ %	
Funct. Gen. = 1kHz					



Table 4-32. HP 8341A Test Record Card (25 of 25)

SPECIFICATIONS TESTED Limits	Step	TEST Conditions	Lower Limit	Measured Value	Upper Limit
<b>4-23. Amplitude Modulation (cont'd)</b>					
HP 8341A Freq. = 3 GHz					
AM Frequency Response	11	Note DVM Indication		_____ Vrms	
Funct. Gen. = 1 kHz	12	Flatness (read on Modulation		_____ dB	≤±0.2 dB
100 Hz	13	Analyzer)		_____ dB	≤±0.2 dB
200 Hz				_____ dB	≤±0.2 dB
500 Hz				_____ dB	≤±0.2 dB
2 kHz				_____ dB	≤±0.2 dB
5 kHz				_____ dB	≤±0.2 dB
10 kHz				_____ dB	≤±0.2 dB
AM Bandwidth	14	Modulation Analyzer	≥-3 dB	_____ dB	
Funct. Gen. = 100 kHz		Indication			
Adjust output level to that					
noted in Step 11					
AM Depth	15	Maximum Modulation Depth	>90%	_____ %	
Funct. Gen. = 1 kHz					
HP 8341A Freq. = 9 GHz					
AM Frequency Response	11	Note DVM Indication		_____ Vrms	
Funct. Gen. = 1 kHz	12	Flatness (read on Modulation		_____ dB	≤±0.2 dB
100 Hz	13	Analyzer)		_____ dB	≤±0.2 dB
200 Hz				_____ dB	≤±0.2 dB
500 Hz				_____ dB	≤±0.2 dB
2 kHz				_____ dB	≤±0.2 dB
5 kHz				_____ dB	≤±0.2 dB
10 kHz				_____ dB	≤±0.2 dB
AM Bandwidth	14	Modulation Analyzer	≥-3 dB	_____ dB	
Funct. Gen. = 100 kHz		Indication			
Adjust output level to that					
noted in Step 11					
AM Depth	15	Maximum Modulation Depth	>90%	_____ %	
Funct. Gen. = 1 kHz					
HP 8341A Freq. = 15 GHz					
AM Frequency Response	11	Note DVM Indication		_____ Vrms	
Funct. Gen. = 1 kHz	12	Flatness (read on Modulation		_____ dB	≤±0.2 dB
100 Hz	13	Analyzer)		_____ dB	≤±0.2 dB
200 Hz				_____ dB	≤±0.2 dB
500 Hz				_____ dB	≤±0.2 dB
2 kHz				_____ dB	≤±0.2 dB
5 kHz				_____ dB	≤±0.2 dB
10 kHz				_____ dB	≤±0.2 dB
AM Bandwidth	14	Modulation Analyzer	≥-3 dB	_____ dB	
Funct. Gen. = 100 kHz		Indication			
Adjust output level to that					
noted in Step 11					
AM Depth	15	Maximum Modulation Depth	>90%	_____ %	
Funct. Gen. = 1 kHz					



## HP 8341A AUTOMATED TEST PROCEDURES

Two software products are available that provide automated tests for the HP 8341A.

The **Basic Package** (HP part number 08340-10009) provides an automated means to:

**Measure Frequency Switching Time.** Frequency Switching time is the time it takes the instrument to implement an HB-IB initiated CW frequency change. The measurement determines the period of time elapsed from when the HP-IB command is received, to the time the instrument frequency settles to within 1 Hz in Band 0 or Band 1, 2 Hz in Band 2, or 3 Hz in Band 3. It is not possible to measure this specification manually.

**Calibrate and verify the optional 90 dB Step Attenuator.** Calibration and verification of the optional 90 dB attenuator can be done with a high level of accuracy by means of this automated test.

The **Advanced Package** (HP part number 08340-10010) provides the two tests described above, as well as exhaustive performance verification (calibration) of the instrument. These tests provide the user with a higher level of confidence than the manual performance tests. This software package reduces the time required to verify instrument performance by greater than 50%.

**Either software package** operates with an HP 9826 or 9836 controller. The part numbers listed above include the 5 1/4 inch disc and software documentation required to run the tests. Both software packages allow the user to print out test results if desired.



**APPENDIX A**  
**IN CASE OF DIFFICULTY: ERROR ANNUNCIATORS**

This section explains what to do when one of the HP 8341A front panel annunciators comes on. It tells you how to tell the difference between a procedural error and actual instrument failure.

Detailed service information and an Overall Instrument Trouble-shooting Guide is available in the Introduction to Section VIII (Service) of the HP 8341A manual, volume 3 of the 4-volume HP 8341A manual set.

Figure A-1, on the next page, shows where the front and rear panel annunciators are located.

Model 8341A - Appendix A

Front View

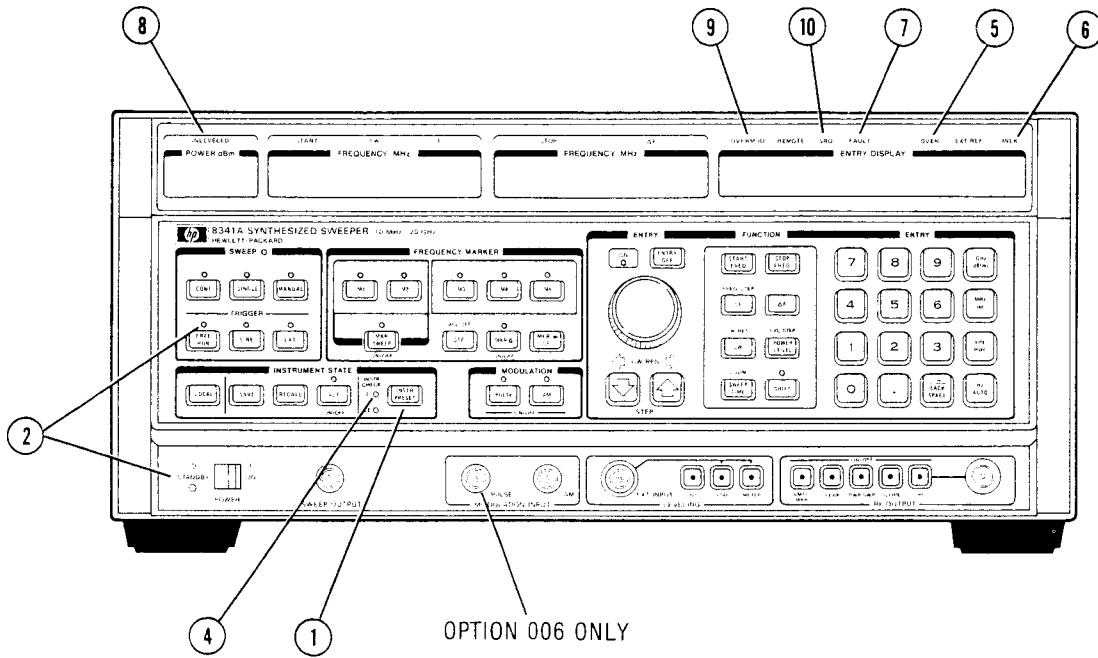

Rear View

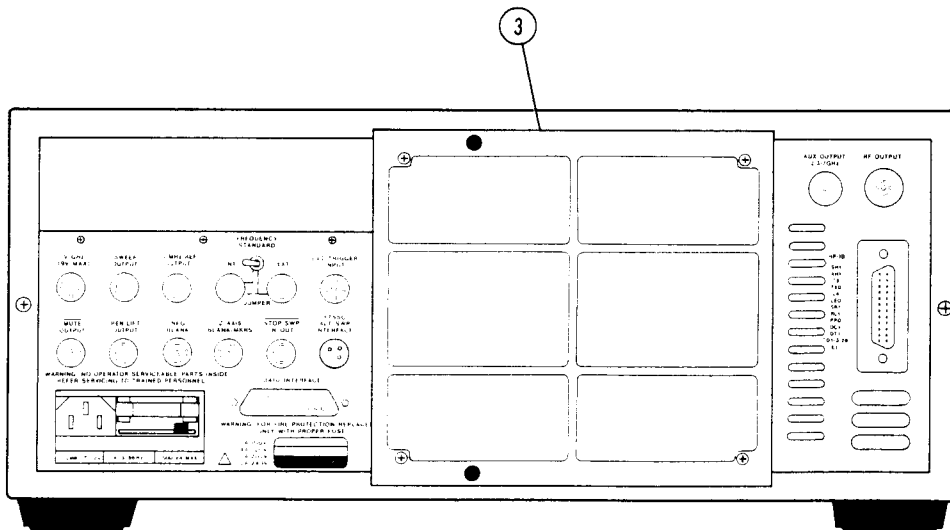

Figure A-1. HP 8341A Error Annunciators

## 1. INSTRUMENT PRESET CONDITIONS [INSTR PRESET]

Press [INSTR PRESET] and check that the following settings exist. If any instrument condition is not as shown below, the instrument requires service.

**POWER dBm** display = 0.0

Factory setting, determined by cal constant #56.

A different power level can be set by changing calibration constant #56. See step 7 of this appendix: Calibration Constant Access Procedure.

**FREQUENCY MHz** display = 10.000000  
**START** annunciator lit

**FREQUENCY MHz** display = 20.000000  
**STOP** annunciator lit

**ENTRY** display = Blank (off)

**SWEEP** block = Green LED flashing  
**CONT** LED on  
**FREE RUN** LED on

**FREQUENCY MARKER** block = All LED's off

**INSTRUMENT STATE** block = All LED's off

**MODULATION** block = All LED's off

**ENTRY** block = All LED's off

**LEVELING** block = INT LED on

**RF OUTPUT** block = RF LED on

The RF output should be a swept 10 MHz to 20 GHz signal, leveled at 0 dBm.

**EXT REF** annunciator = off.

If the rear panel **INT** or **EXT REFERENCE** switch is in the **EXT** position, the **EXT REF** annunciator above the **ENTRY DISPLAY** will be on.

## 2. INCORRECT FRONT PANEL STATES after [INSTR PRESET]

**All LED's Off.**

**FAN IS OPERATING** - If all annunciators and LED's are off (but the instrument's fan is operating), check the thermal shutdown switch (A62SI) in the HP 8341A power supply. If the switch has engaged, make sure the fan is supplying proper airflow to

the interior of the instrument. Make sure the fan filter is not blocked by dust build-up, a piece of paper, etc. If the instrument's airflow is good, suspect a power supply failure.

**FAN IS NOT OPERATING, LED'S COME ON AT POWER ON, THEN GO OUT LATER** - Refer to the **FAN** section, below.

**FAN IS NOT OPERATING, LED'S OFF AT POWER ON** - If all instrument LED's are off and the fan is not operating, suspect a problem in the instrument causing complete loss of ac mains, ie transformer, wiring, or line filter module related problems. Check the line filter module voltage select card (Refer to Section II, Installation).

**SOME LED'S OFF.** If some LED's that should be on are off, the HP 8341A front panel section is probably the cause.

**ALL LED'S ON.** If all of the LED's and annunciators are on, the HP 8341A processor, memory, or power supply is probably the cause.

**CHARACTER MARCH.** If the four display windows have strings of characters marching across them, the HP 8314A processor or memory is probably the cause.

### 3. FAN

**FAN DOES NOT TURN ON.** When the **POWER** switch is turned **ON**, the instrument fan should start running. If it does not, the fan, power supply, or K1 Relay (inside the instrument near the rear panel) is probably the cause.

If the instrument has run for some time with the fan not running, the interior temperature may have risen to the point that the A62S1 thermal switch has turned the instrument off. If so, all front panel LED's will have gone off. The switch will reset itself when the instrument cools down.

**FAN DOES NOT TURN OFF.** When the HP 8341A is in the **STANDBY** mode, the fan should not be running. If it is, the Fan Relay (K1) may be stuck, or it the +22V supply has failed. The fan relay solenoid is *energized* when the instrument is in the **STANDBY** mode, turning the fan *off*. If the power to the relay solenoid fails (+22V supply), the solenoid will *de-energize*, turning the fan *on*.

### 4. INSTR CHECK LED'S REMAIN ON

**INSTR CHECK LED'S I and II** show the results of the instrument Self-Test sequence. This test sequence is carried out every time the **POWER** switch is turned on or when **[INSTR PRESET]** is pressed. It takes about 00 seconds and begins by turning both check LED's on. Both LED's should be off after about 00 seconds.

**INSTR CHECK LED I REMAINS ON.** If so, the A60 Processor board is the cause.

**INSTR CHECK LED II REMAINS ON.** If so, the A60 Processor board or the HP 8341A instrument data bus or address bus is the cause.



## 5. OVEN ANNUNCIATOR

The front panel **OVEN** light is used to indicate the status of the internal frequency standard. When the **OVEN** annunciator is on, the frequency is more than 100 Hz from 10 MHz.

If the internal 10 MHz standard is being used, this will cause the frequency of the RF output to be inaccurate. The **OVEN** annunciator should go out within one half hour after the instrument is connected to ac mains. If the **OVEN** annunciator stays on, the instrument requires service.

If the instrument is using an external 10 MHz standard, this indication will have no effect on instrument performance.

## 6. UNLK ANNUNCIATOR

The **UNLK** light is used to indicate that one or more of the six instrument phase lock loops is unlocked. Press **[SHIFT] [EXT]**. The **ENTRY DISPLAY** will show the following:

**OSC: REF M/N HET YO N2 N1**

The name of the phase lock loop that is unlocked will be flashing. The different loops are listed below along with information about what to do if one of them is unlocked.

**REF** - If **REF** (reference loop) is flashing, inspect the rear panel, one of two conditions should exist:

### A. If instrument is in internal 10 MHz mode:

Make sure the **INT STANDARD BNC** and the **EXT STANDARD BNC** are connected together with a jumper cable. Ensure that the rear panel **REFERENCE** switch is in the **INT** position. If this is the case and **REF** is flashing, the instrument requires service. Suspect a problem in the Reference Loop.

### B. If instrument is in external 10 MHz mode:

An external 10 MHz standard should be connected to the **EXT STANDARD BNC** with the rear panel **REFERENCE** switch in the **EXT** position. If this is the case and **REF** is flashing, connect the instrument as described in step A, above. Press **[SHIFT] [EXT]**.

If **REF** keeps flashing, the instrument requires service. Suspect a problem in the Reference Loop.

If **REF** stops flashing the problem is being caused by the external 10 MHz Reference Standard.

**M/N** - If **M/N** is flashing, the instrument requires service. Suspect the **M/N** Loop.

**HET** - If **HET** is flashing the instrument requires service. Suspect a problem in the 3.7 GHz Oscillator in the RF section.

**YO** - If **YO** is flashing, the instrument requires service. Suspect the **YO** loop.

## Model 8341A - Appendix A

- N1 - If N1 is flashing, the instrument requires service. Suspect a problem in the PLL1 or PLL3 Loops in the 20-30 Loops.
- N2 - If N2 is flashing, the instrument requires service. Suspect a problem in the PLL2 loop in the 20-30 Loops.

### 7. FAULT ANNUNCIATOR

The **FAULT** light is used to monitor the status of 5 different internal functions. These functions are described below. If the **FAULT** light is on, press **[SHIFT] [MANUAL]**. The **ENTRY DISPLAY** will show the following:

#### **FAULT: CAL KICK ADC PEAK TRK**

The name of the function that has a problem will be flashing.

- CAL** - This refers to the calibration constants stored in memory (on the A60 Processor board). The calibration constants are checked only when an **[INSTR PRESET]** is done. If **CAL** is flashing the instrument has resorted to default calibration constant data. The major effect of this condition will be RF power output flatness and accuracy degradation. To remedy this situation, the factory-determined calibration constants must be re-entered into the instrument's memory. Remove the top cover of the instrument. Get the print-out of the calibration constants from the plastic jacket located on the left-hand side of the instrument. Replace the instrument's top cover. The following procedure must be performed to enter the calibration constants back into memory. When this procedure is complete, place the calibration constant print-out back into the instrument.

### CAUTION

The following procedure affects data required for optimum performance of the instrument. Care should be taken when accessing or changing calibration data.

#### Calibration Constant Access Procedure

1. Press **[SHIFT] [GHz] [1] [Hz]**  
**[SHIFT] [MHz] [1] [2] [Hz]**  
**[SHIFT] [KHz] [2] [2] [Hz]**

The value of calibration Constant #1 will be displayed in the **ENTRY DISPLAY**.

2. Compare the value on the **ENTRY DISPLAY** with the value listed in the print-out. If the values do not match, enter the value from the print-out via the **DATA ENTRY** keyboard and then press **[Hz]**. Press the up **STEP** key to view the next calibration constant.
3. Repeat step 2 until all the instrument calibration constants are the same as those shown on the print-out.
4. Store the entered calibration constants into protected memory by pressing the following keys:

[SHIFT] [MHZ] [1] [4] [Hz]  
[SHIFT] [MHZ] [1] [9] [4] [6] [Hz]

The "CALIBRATION STORED" message will appear in the **ENTRY DISPLAY**.

Press [INSTR PRESET], the **FAULT** indicator should be off. If it is still on, suspect a problem with the instrument's memory.

- KICK** - This refers to the kick pulses used to reset the YO (YIG Oscillator) and SYTM (Switched YIG-Tuned Multiplier). Suspect a problem in the A54 YIG Oscillator Pretune assembly or the A28 SYTM Driver board.
- ADC** - This refers to a check performed on the ADC (analog to digital converter) circuits on the A27 Level Control board. This check is done at [INSTR PRESET] or power on. ADC indicates that the **POWER dBm** display may indicate a different power than the instrument is actually producing. Also, an ADC failure will not allow the Peak ([PEAK]) and Auto Tracking ([SHIFT] [PEAK]) functions to operate properly. If this annunciator is on, suspect a problem on the A27 Level Control board.
- PEAK** - This refers to an instrument function that peaks the RF output power at a **CW frequency** by fine tuning the SYTM (the SYTM is tuned to the YO frequency). This fault can only come on if the [PEAK] button is pushed. If **PEAK** is flashing, something is wrong with the circuitry that peaks the SYTM. **PEAK** indicates that the instrument is not able to optimize its output power. This is an instrument failure which requires service to correct. However, the optimum power may not be adversely affected and may still be acceptable to the operator.
- TRK** - This refers to an instrument function that peaks the RF output power while the instrument is **sweeping**. This fault can only occur if [SHIFT] [PEAK] has been pushed. The **TRK** light indicates the same things as if **PEAK** were flashing.

## 8. UNLEVELED ANNUNCIATOR

The **UNLEVELED** light is used to indicate the status of the RF output power. If the **UNLEVELED** light is off, the output power is leveled and if the light is on, the power is unleveled.

- A. Make sure that the correct leveling mode is selected. If internal leveling is desired, the **INT** light should be on. If external leveling is desired, the **XTAL** light should be on. If power meter leveling is desired, the **METER** light should be on. The three lights just mentioned are located on the associated front panel keys.
- B. The power level requested should not be greater than the maximum power specification at a given frequency. If the instrument is sweeping, make sure that the power requested does not exceed the maximum power specification for the entire band or bands that are being swept.
- C. If the output power is unleveled at all power levels and all frequencies, suspect a problem on the A25 ALC Detector board, the A26 Linear Modulator board, or the RF path.

- D. If the power will level at some frequencies and not others while the instrument is sweeping, the SYTM may not be tracking correctly. Try the AUTO TRACKING feature by pressing [SHIFT] [PEAK].
- E. If the power will level at some CW frequencies and not at others, press [PEAK] to optimize the SYTM tracking at the frequency of interest.
- F. If the power is unlevelled in Band 0 (10 MHz to 2.3 GHz) only, suspect a problem in the switching circuits on the A25 ALC Detector board, the A26 Linear Modulator board, the A12 Band 0 detector, or the associated microcircuits.
- G. If the power is unlevelled in bands 1-3 (2.3 GHz to 20.0 GHz) only, suspect a problem in the switching circuits on the A25 ALC Detector board, A26 Linear Modulator board, the A11 Band 1-3 Detector, or the associated microcircuits.

**NOTE**

**Refer to the ALC Loop Overview in Section III of this volume.**

**9. OVERMOD ANNUNCIATOR**

Overmod indicates that the RF power is turned completely off and a signal (AM or, if instrument is so equipped, Pulse Modulation) is attempting to shut it off even further. Make sure an external AM signal is not exceeding specified voltage limits (the AM input allows a 0 to +/-1 volt signal).

**10. SRQ ANNUNCIATOR**

To understand the **SRQ** annunciator, a brief description of SRQ (Service Request) is necessary. The way the SRQ works is described below:

SRQ is only used when the HP 8341A is connected to an external controller (via HP-IB). The controller picks one or more conditions under which the HP 8341A will send out a service request (SRQ). The controller then programs the HP 8341A to send an SRQ when one of these conditions occurs.

When one of the programmed conditions occurs, the HP 8341A sends out an SRQ signal and activates the **SRQ** annunciator.

When the controller responds to the SRQ (by doing a serial poll command) the HP 8341A turns the **SRQ** annunciator off. This entire process takes but a fraction of a second, so the time the **SRQ** annunciator stays on is normally very brief.

**SRQ Annunciator Stays On**

If the **SRQ** annunciator goes on and stays on it usually indicates that one of the following conditions exists:

- A. **IF THE HP 8341A IS CONNECTED TO AN EXTERNAL CONTROLLER:** the computer controller is not able to service the SRQ interrupt. This problem is usually caused by the controller being stuck in a loop, etc. and not by a fault in the HP 8341A.

Model 8341A - Appendix A

- B. IF THE HP 8341A IS NOT CONNECTED TO AN EXTERNAL CONTROLLER:  
This usually happens when a controller has programmed the HP 8341A to send an SRQ and has subsequently been disconnected.

